



1 9 5 3

2 0 2 3

Al **Sig. Luigi De Luca**

che ha dato vita ad un successo

che dura **70 anni!**

To **Mr Luigi De Luca**

who started a **70-year**

success story!



Da 70 anni il nostro impegno è improntato a realizzare la miglior offerta di complementi dal design italiano per **innovazione, ampiezza di gamma e competitività**. Il nostro servizio ha il fine ultimo di creare valore per collaboratori, partner e clienti, unendo la professionalità alla responsabilità sociale e ambientale.

Dal 1953, diamo il tocco finale per il tuo bagno.

For 70 years, our commitment has been focused on making the best offer of complements from Italian design in terms of **innovation, range breadth and competitiveness**. Our service has the ultimate goal of creating value for employees, partners and customers, combining professionalism with social and environmental responsibility. **Since 1953, we have been giving**

your bathroom's final touch.

1 9 5 3 - 2 0 2 3

1953

Azienda fondata da Luigi De Luca.

Company founded by Luigi De Luca.

1972

Prima serie in ABS.

First range in ABS

1977

MoMA June 27, 1977
In permanent Design Collection of the Museum of Modern Art in New York

GEDY entra al MOMA di New York con Cucciolo.

GEDY enters New York's MOMA with Cucciolo.

1994

Prima serie di accessori in metallo.

First range of metal accessories.

1968

Produzione accessori bagno in legno, porcellana e resina.

Production of bathroom accessories in wood, porcelain and resin.

1974

Nasce il Cucciolo.

The Cucciolo is created.

1983

Fondazione di GEDY Iberica S.A.

GEDY Iberica S.A. is founded.

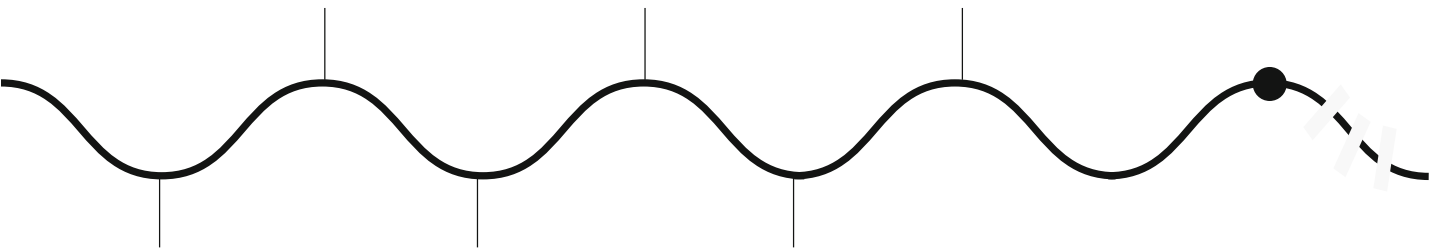

2011

Green Good Design Award by Museum of Architecture & Design Chicago con lo sgabello Yannis.

Green Good Design Award by Museum of Architecture & Design Chicago with Yannis stool.

2023

Settantesimo anniversario dalla fondazione. Lancio della "nuova" identità GEDY.

Seventieth anniversary. Launch of the "new" GEDY identity.

2002

Trasferimento uffici a Origgio e ampliamento magazzino.

Offices transferred to Origgio and expansion of warehouse.

1997

Acquisizione e trasferimento del magazzino ad Origgio.

Acquisition and transfer of warehouse to Origgio.

2010

Automazione del sistema di spedizione.

Automation of shipment system.

2013

Sessantesimo anniversario dalla fondazione. Lancio della "nuova" identità Gedy Premio miglior stand Cersaie.

Sixtieth anniversary. Launch of the "new" GEDY identity. Best stand award by Cersaie fair.



1 9 5 3
2 0 2 3

Indice.

SERIE DA MURO. WALL SERIES.

06

2900 _____	192	Fuji _____	144	Nevis _____	122
Atena _____	62	Gea _____	42	New Jersey _____	130
Azzorre _____	22	Genziana _____	180	Olimpo _____	160
Bernina _____	110	Glamour _____	88	Outline _____	34
Bridge _____	60	Gran Torino _____	104	Pirenei _____	92
Canarie _____	28	Himalaya _____	202	Project _____	80
Cervino _____	168	Hot _____	186	Romance _____	114
Colorado _____	118	Il Giglio _____	8	Samoa _____	52
Darios _____	190	Junior _____	196	Spluga _____	126
Edera Plus _____	134	K2 _____	176	Stelvio _____	148
Elba _____	18	Kansas _____	100	Teide _____	164
Eros _____	70	Kent _____	84	Tonale _____	152
Everest _____	172	Lanzarote _____	14	Tonga _____	140
Febo _____	66	Lounge _____	46	Ventus _____	178
Felce _____	156	Maui _____	56	Vermont Pro _____	76
Ficus _____	184	Maine _____	106	Vesuvio _____	200
				Wizard _____	138

SERIE DA APPOGGIO. TABLE TOP.

204

Afrodite _____	215	Giunone _____	214	Ninfea _____	251
Alexia _____	240	Glady _____	290	Petra _____	282
Altea _____	217	Helen _____	280	Petunia _____	242
Amelie _____	222	Idra _____	269	Polaris _____	208
Antares _____	264	Ilary _____	235	Primula _____	211
Aries _____	256	Irina _____	259	Pyxis _____	285
Astrid _____	225	Iside _____	253	Quadrotto _____	272
Azalea _____	239	Karima _____	243	Rainbow _____	266
Betty _____	210	Kira _____	277	Sabina _____	237
Bonnie _____	218	Kelly _____	244	Seventy _____	286
Brenda _____	283	Layla _____	278	Seventy Ekoplà _____	289
Calipso _____	213	Libra _____	255	Sharon _____	292
Catherine _____	229	Lounge _____	206	Silverino _____	295
Chanelle _____	262	Lucy _____	228	Sofia _____	254
Chantal _____	236	Lucrezia _____	223	Sole _____	274
Cixi _____	219	Marina _____	221	Spot _____	295
Clothilde _____	224	Marika _____	232	Thea _____	252
Corinne _____	248	Myosotis _____	220	Twist _____	260
Dafne _____	216	Moby _____	294	Vega _____	276
Dalia _____	241	Naomi _____	231	Verbena _____	246
Dori _____	284	Nemesia _____	209	Vivienne _____	234
Elettra _____	207	New Martina _____	230	Yvonne _____	279
Gemini _____	270	New Mizar _____	226	Wilma _____	238
Gioia _____	250	Nicole _____	247	Zoe _____	258
Giulia _____	268	Nigella _____	212		

SPECCHI E ILLUMINAZIONE. MIRRORS AND LIGHTING.

296

• Specchi con luci - Mirrors with lights _____	298
• Specchi senza luci - Mirrors without lights _____	311
• Specchi contenitori e armadietti - Mirror cabinets _____	319
• Illuminazione - Lighting _____	322
• Specchi ingranditori - Magnifying mirrors _____	327

ACCESSORI WC . WC ACCESSORIES .**3 3 2**

• Poubelles - Waste baskets _____	3 3 4
• Scopini wc da muro - Wall toilet brush holders _____	3 4 0
• Scopini wc - Toilet brush holders _____	3 4 5
• Sedili wc - Wc seats _____	3 6 0

COMPLEMENTI D'ARREDO . FURNISHING ACCESSORIES .**3 6 6**

• Piantane - Towel stands _____	3 6 8
• Appendiabiti - Hooks _____	3 9 2
• Porta phon - Hairdryer supports _____	4 0 2
• Sgabelli - Stools _____	4 0 5
• Organizer - Organizers _____	4 1 0
• Portabiancheria - Laundry baskets _____	4 1 5
• Mensole - Shelves _____	4 1 8
• Bilance elettroniche - Electronic scales _____	4 1 9

ACCESSORI DOCCIA . SHOWER ACCESSORIES .**4 2 0**

• Portaoggetti doccia - Shower caddies _____	4 2 2
• Tergivetro - Wiper blades _____	4 3 8
• Tappeti antiscivolo - Non slip mats _____	4 4 1
• Tappetini antiscivolo lavello - Sink-Mats _____	4 4 6
• Pedane doccia - Shower platforms _____	4 4 7
• Sedili per doccia e vasca - Shower and bath tub seats _____	4 4 8
• Tende doccia - Shower curtains _____	4 5 2
• Telai doccia - Shower rails _____	4 8 6

TAPPETI DA BAGNO . BATH RUGS .**4 9 2****IDROTERAPIA . HYDROTHERAPY .****4 9 8**

• Doccette - Hand showers _____	5 0 0
• Duplex - Shower kits _____	5 1 2
• Set doccia - Shower sets _____	5 2 0
• Saliscendi - Shower slider rails _____	5 2 5
• Colonne doccia - Shower columns _____	5 3 1
• Pannelli doccia - Shower panels _____	5 4 1
• Soffioni - Shower heads _____	5 4 7
• Flessibili - Hoses _____	5 5 4
• Accessori - Accessories _____	5 5 7
• Idraulica - Taps accessories _____	5 6 6

CONTRACT .**5 6 8**

• Distributori di sapone e gel igienizzante - Dispensers for soap and sanitizer gel _____	5 7 0
• Phon con supporto a parete - Hair dryers with wall support _____	5 7 9
• Asciugamani elettrici - Air hand dryers _____	5 8 0
• Distributori di carta - Paper towel dispensers _____	5 8 3
• Materiali di consumo - Refills _____	5 9 0
• Filo stendibiancheria riavvolgibile - Retractable clothes line _____	5 9 1
• Mesole porta asciugamani - Shelves for towels _____	5 9 1
• Maniglioni - Grab bars _____	5 9 5
• Project _____	6 0 0
• Prima Classe _____	6 0 4
• Sicura _____	6 1 0
• Fortis _____	6 1 4
• Friend _____	6 1 7

BAMBOOM . ЕКОПЛА .**6 1 8**

ATTENZIONE: le quote sono puramente indicative, NON considerarle per l'esecuzione delle forature.

ATTENTION: measurements are indicative. DO NOT use them to drill holes.

ATTENTION: les cotes sont fournies à titre indicatif, NE PAS en tenir compte pour la réalisation des perçages.

ACHTUNG: die Quoten dienen als Anhaltspunkte; sie NICHT zur Ausführung der Bohrungen heranziehen!

ATENCIÓN: las medidas son indicativas, NO tenerlas en cuenta para realizar los orificios.

ВНИМАНИЕ: измерения являются ориентировочными. НЕ используйте их для сверления отверстий.

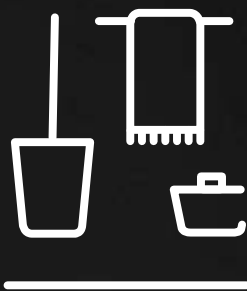

SERIE
DA MURO
Wall lines



Il Giglio.

design Makio Hasuike*



Realizzata in ottone, acciaio inox AISI 304 e Cromall® con contenitori in vetro satinato

Made of brass, AISI 304 stainless steel and Cromall® with frosted glass containers

Réalisée en laiton, acier inoxydable AISI 304 et Cromall® avec boîtiers en verre satiné

Hergestellt aus Messing, Edelstahl AISI 304 und Cromall® mit Behältern aus satiniertem Glas

Realizada en latón, acero inox AISI 304 y Cromall® con contenedores en cristal satinado

Изготовлено из латуни, нержавеющей стали AISI 304 и Cromall® с ёмкостями из матового стекла



Con viti
With screws



GARANZIA
WARRANTY



MADE
in Italy

esclusi prodotti con **
excluding items with **



13
Cromato
Chromed

esclusi prodotti con *
excluding items with *

Il Giglio.

SERIE DA MURO
Wall series



SERIE DA MURO . WALL LINES .

TOP DESIGN



Il Giglio.

SERIE DA MURO
Wall series

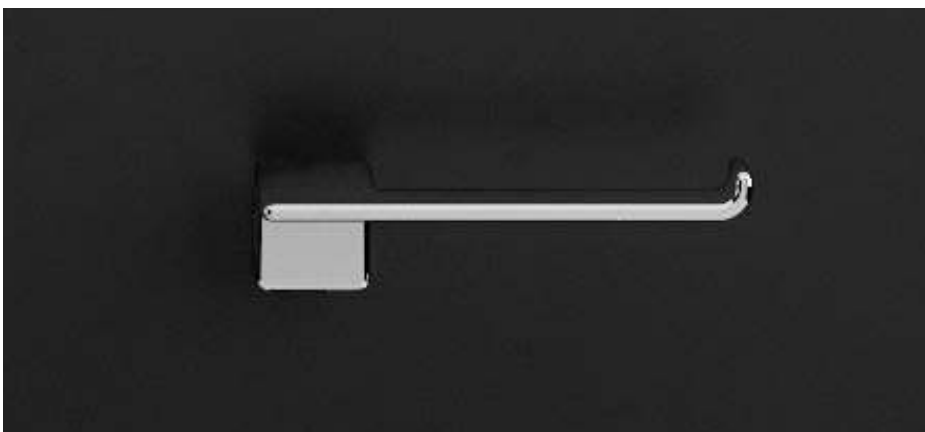

SERIE DA MURO . WALL LINES .

TOP DESIGN



A910

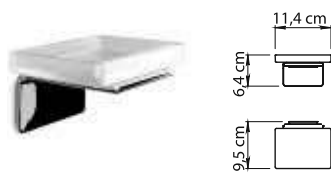

A911

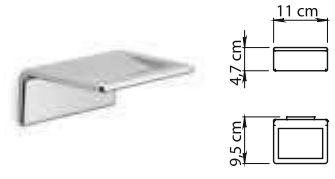

A912



A981

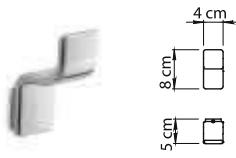

A926

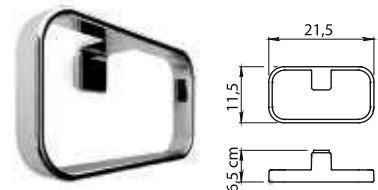

A970

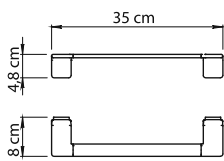

A921-35

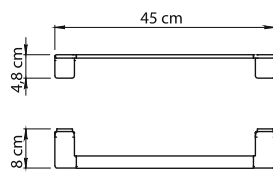

A921-45

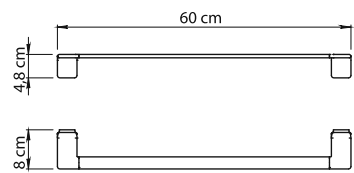

A921-60

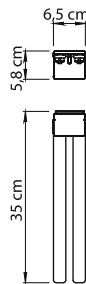

A923

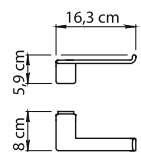

A924

Il Giglio.

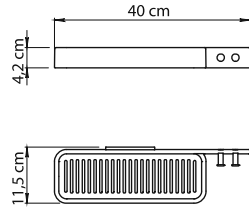

A918**

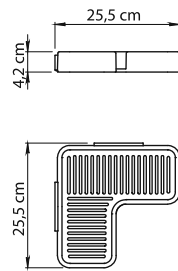

A983**

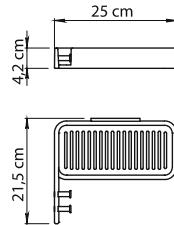

A919**



Ottone e alluminio
Brass and aluminium
Laiton et aluminium
Messing und Aluminium
Latón y aluminio
Латуни и алюминия

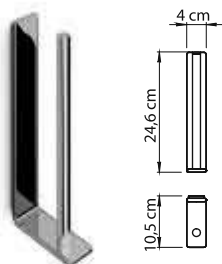

A924-02



A925

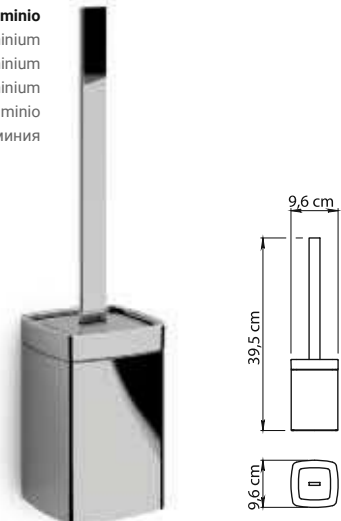

A933**

Lanzarote.

Realizzata in ottone e Cromall® con contenitori in vetro satinato

Made of brass and Cromall® with frosted glass containers

Réalisée en laiton et Cromall® avec boîtiers en verre satiné

Hergestellt aus Messing und Cromall® mit Behältern aus satiniertem Glas

Realizada en latón y Cromall® con contenedores en cristal satinado

Изготовлено из латуни и Cromall® с ёмкостями из матового стекла



Con viti

With screws



GARANZIA

WARRANTY



13

Cromato
Chromed

Lanzarote.

SERIE DA MURO
Wall series



SERIE DA MURO . WALL LINES .

TOP DESIGN

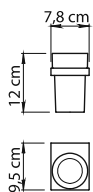
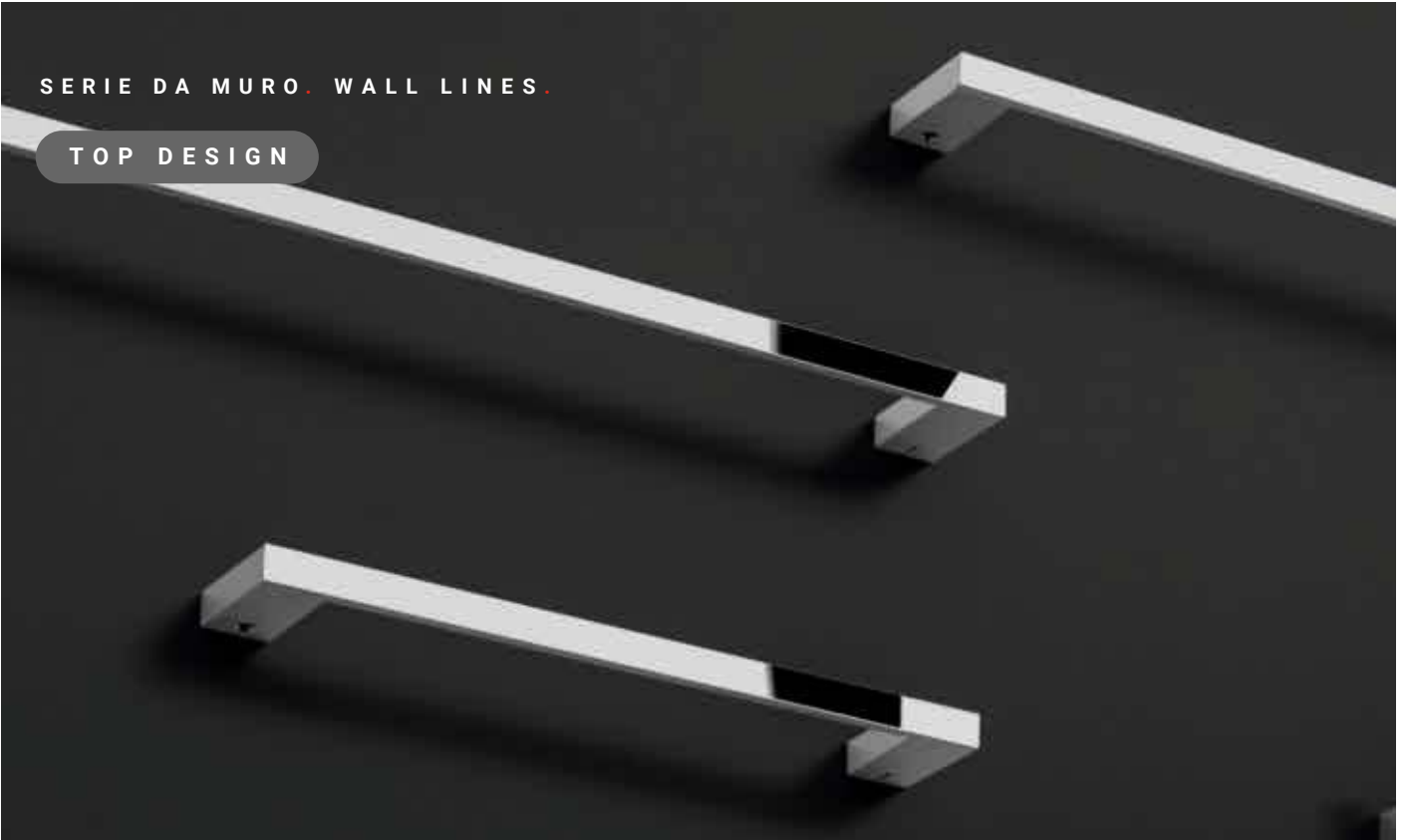

A310

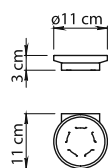

A311

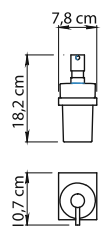

A381

Lanzarote.

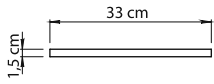

A321-30

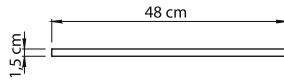

A321-45

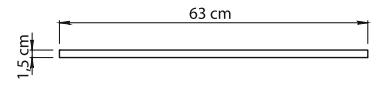

A321-60

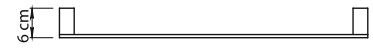

A370

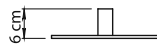
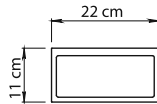

A323

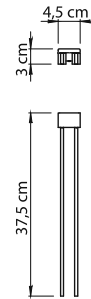

A324

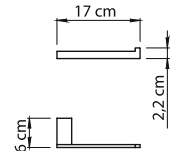

A326

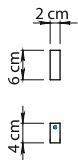

A325

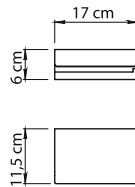

A329

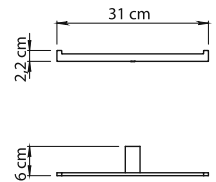

A333-03

Manico telescopico
Telescopic handle
Manche télescopique
Ausziehbarer Stiel
Mango telescópico
Телескопической ручкой



Elba.

Realizzata in ottone, alluminio e Cromall® con contenitori in vetro satinato

Made of brass, aluminium and Cromall® with frosted glass containers

Réalisée en laiton, aluminium et Cromall® avec boîtiers en verre satiné

Hergestellt aus Messing, Aluminium und Cromall® mit Behältern aus satiniertem Glas

Realizada en latón, aluminio y Cromall® con contenedores en cristal satinado

Изготовлено из латуни, алюминия и Cromall® с ёмкостями из матового стекла



Con viti

With screws



Con colla

With glue

(Venduta a parte
Sold seperately)



GARANZIA

WARRANTY



13

Cromato
Chromed

Elba.

SERIE DA MURO
Wall series

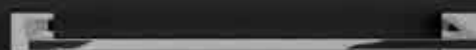
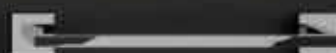
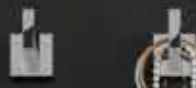
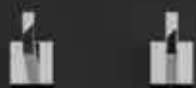

SERIE DA MURO . WALL LINES .

TOP DESIGN



Elba.



A010

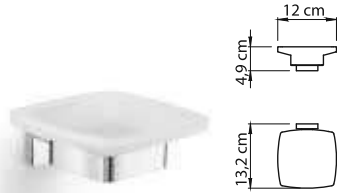

A011

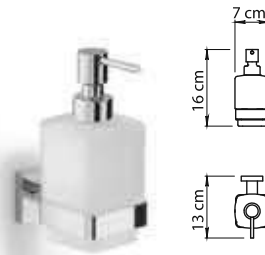

A081

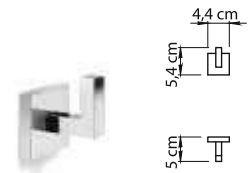

A026

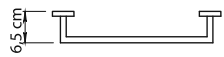
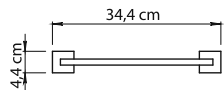

A021-30

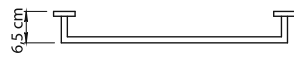
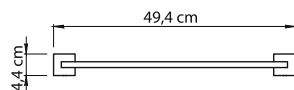

A021-45

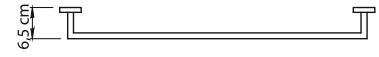
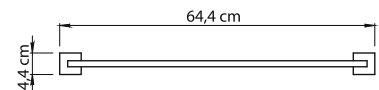

A021-60



A070

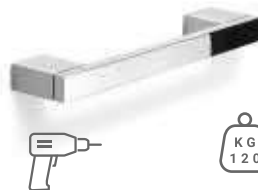
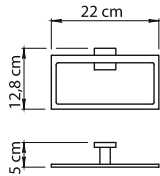

Solo con viti
Only with screws

A021-28

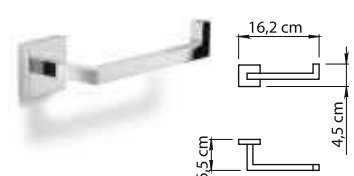

A024

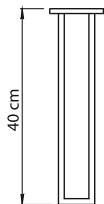
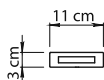

A022

Solo con viti
Only with screws



A033

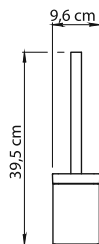

A033-03

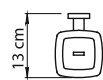
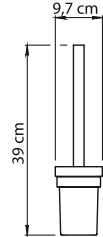

Azzorre.

Realizzata in alluminio, ottone e Cromall® con contenitori in vetro satinato

Made of aluminium, brass and Cromall® with frosted glass containers

Réalisée en aluminium, laiton et Cromall® avec boîtiers en verre satiné

Hergestellt aus Aluminium, Messing und Cromall® mit Behältern aus satiniertem Glas

Realizada en aluminio, latón y Cromall® con contenedores en cristal satinado

Изготовлено из алюминия, латуни и Cromall® с ёмкостями из матового стекла



Con viti

With screws



GARANZIA

WARRANTY



13

Cromato
Chromed

Azzorre.

SERIE DA MURO
Wall series



SERIE DA MURO . WALL LINES .

TOP DESIGN





Azzorre.

SERIE DA MURO
Wall series

SERIE DA MURO . WALL LINES .

TOP DESIGN



A110



A111



A181



A121-30



A121-45



A121-60

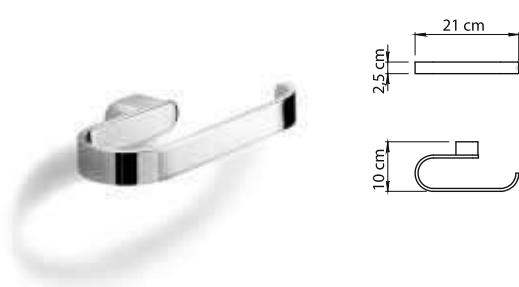

A170



A123

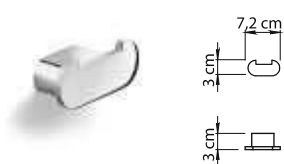

A126



A124

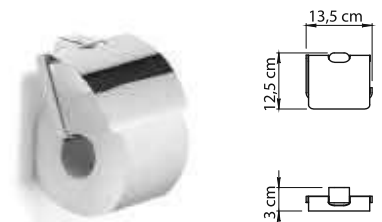

A125

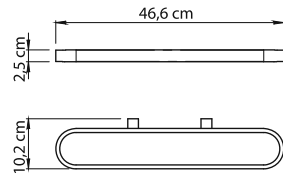

A147

Accessori venduti separatamente

Accessoires supplied separately

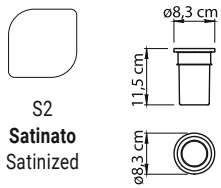

A198

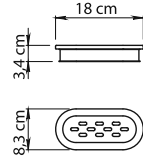

A151

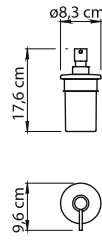

A155

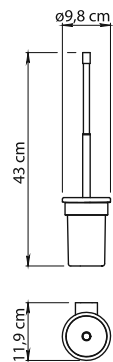

A133-03

Manico telescopico
Telescopic handle
Manche télescopique
Ausziehbares Stiel
Mango telescópico
Телескопической ручкой

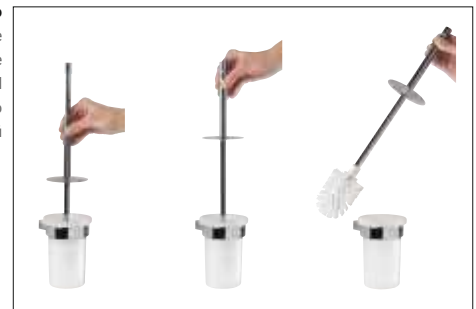

Canarie.

Realizzata in ottone e Cromall® con contenitori in vetro satinato

Made of brass and Cromall® with frosted glass containers

Réalisée en laiton et Cromall® avec boîtiers en verre satiné

Hergestellt aus Messing und Cromall® mit Behältern aus satiniertem Glas

Realizada en latón y Cromall® con contenedores en cristal satinado

Изготовлено из латуни и Cromall® с ёмкостями из матового стекла



Con viti

With screws



GARANZIA

WARRANTY



13

Cromato
Chromed

Canarie.

SERIE DA MURO
Wall series



SERIE DA MURO . WALL LINES .

TOP DESIGN



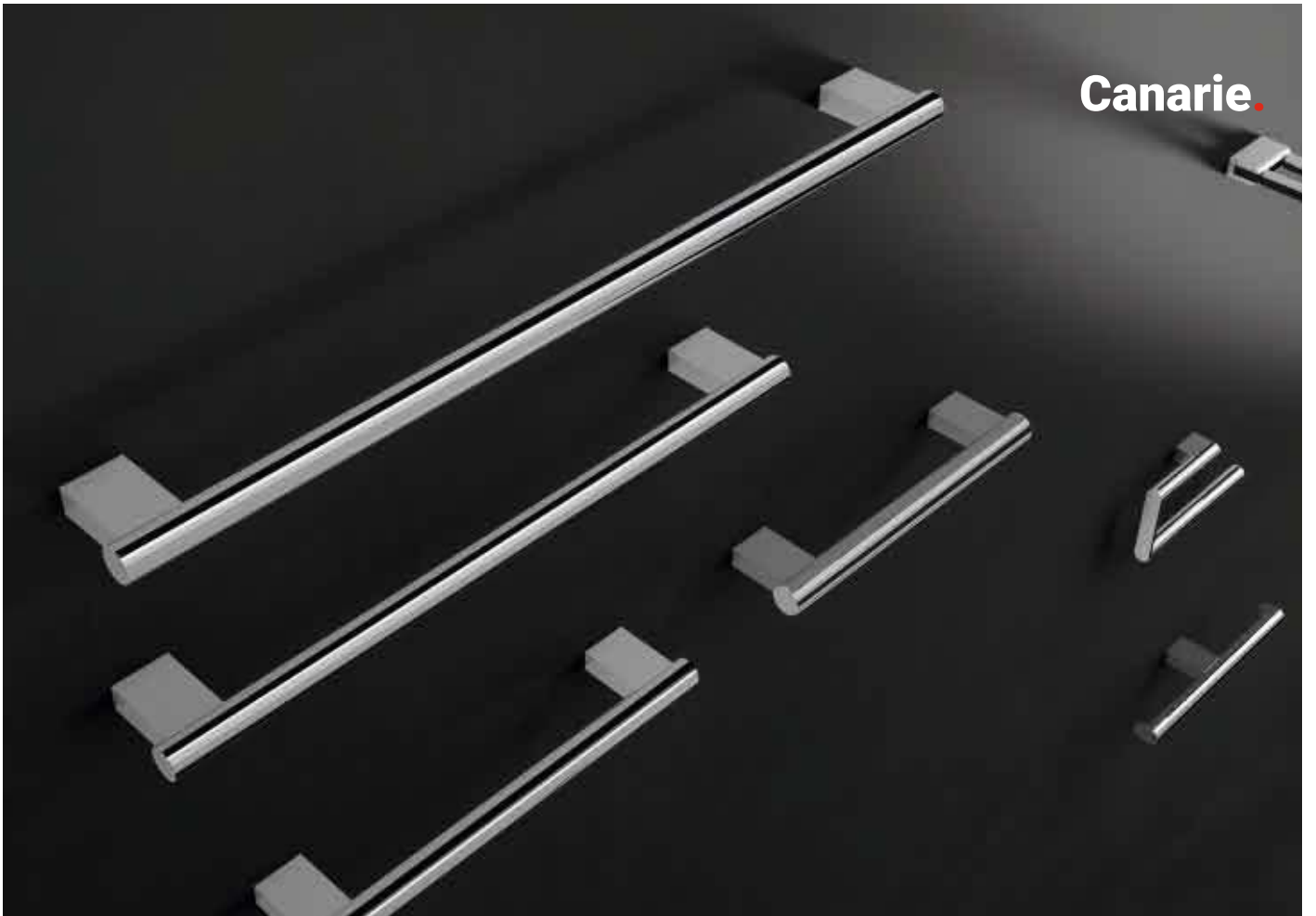

A210

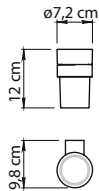

A211

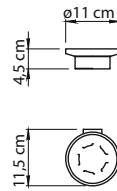

A281

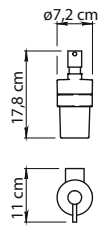

AISI
304

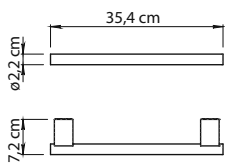

A221-30

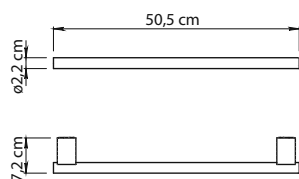

A221-45

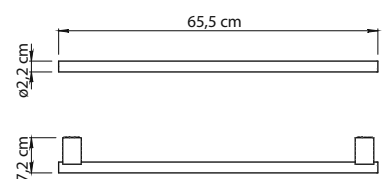

A221-60

SERIE DA MURO . WALL LINES .

TOP DESIGN

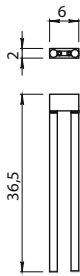

A223

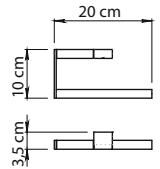

A270

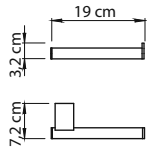

A224

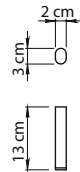

A224-02

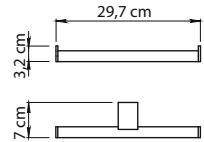

A229

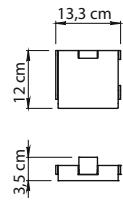

A225

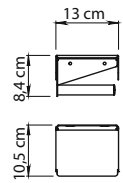

A225-01

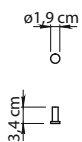

A227

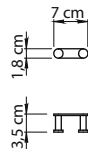

A226

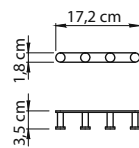

A228

Canarie.

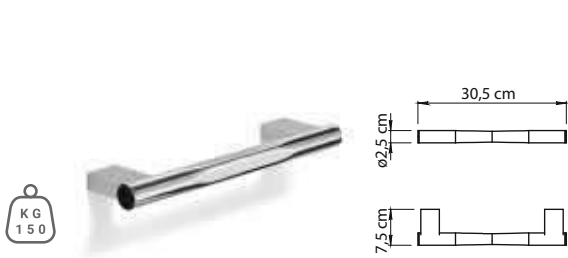

A221-28

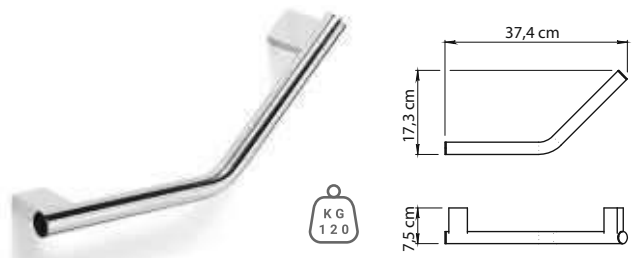

A222



A235

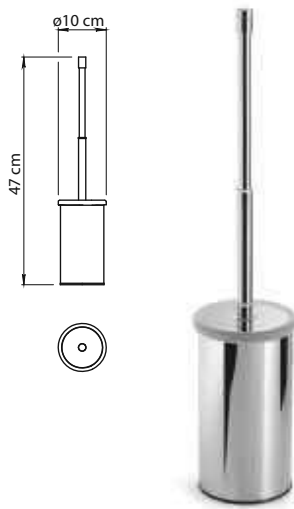
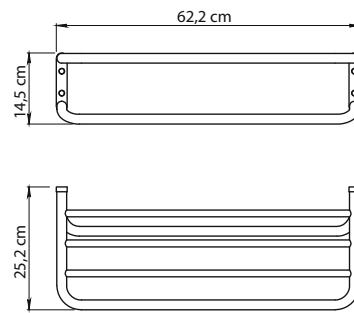

Acciaio inox
Stainless steel
Acier inoxydable
Edelstahl
Acero inox
Нержавеющая сталь

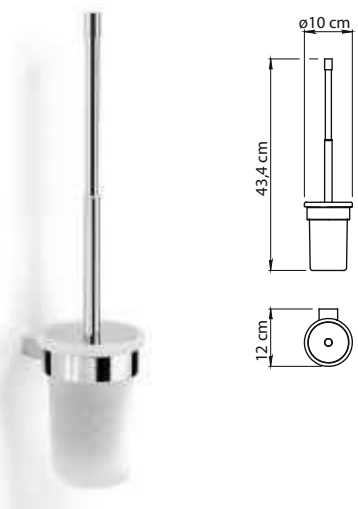

Manico telescopico
Telescopic handle
Manche télescopique
Ausziehbarer Stiel
Mango telescópico
Телескопической ручкой



A233



A233-03

Outline.

design Simone Micheli

Realizzata in ottone, acciaio inox e Cromall®

Made of brass, stainless steel and Cromall®

Réalisée en laiton, acier inoxydable et Cromall®

Hergestellt aus Messing, Edelstahl und Cromall®

Realizada en latón, acero inox y Cromall®

Изготовлено из латуни, нержавеющей стали и Cromall®



Con viti
With screws



GARANZIA
WARRANTY



13
Cromato
Chromed



14
Nero matt
Matt black



22
Bianco matt
Matt white

Outline.

SERIE DA MURO
Wall series



SERIE DA MURO . WALL LINES .

TOP DESIGN





SERIE DA MURO. WALL LINES.

TOP DESIGN

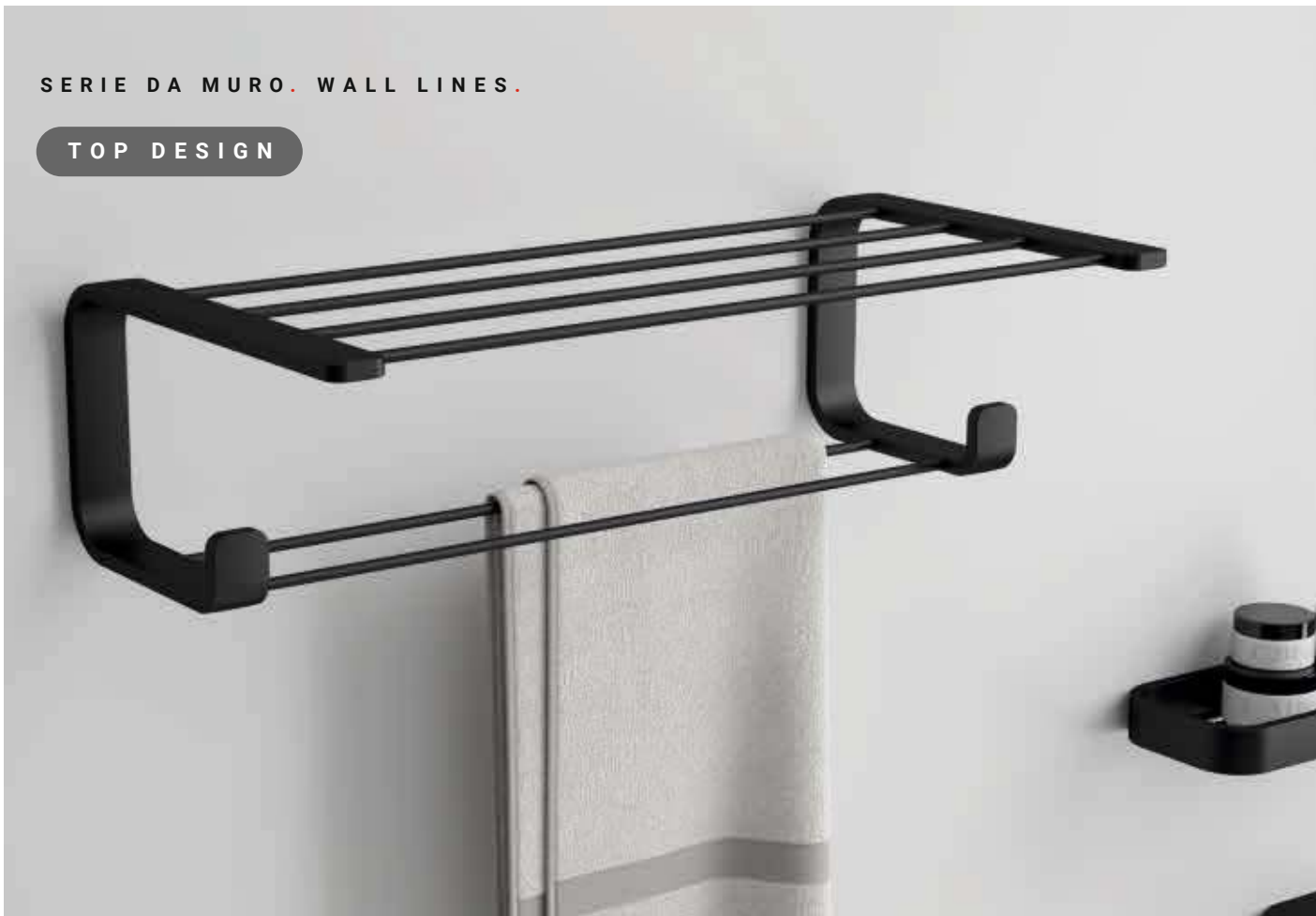

Outline.

SERIE DA MURO
Wall series



SERIE DA MURO . WALL LINES .

TOP DESIGN

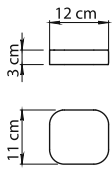

3212

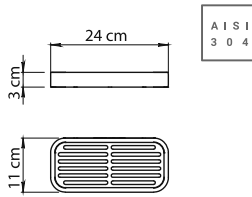

3218

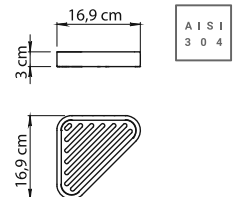

3283

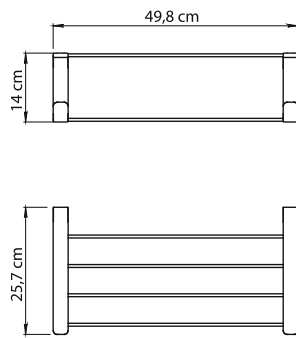

3235

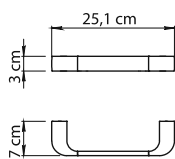

3221-25

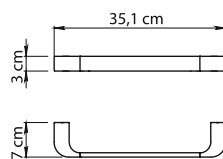

3221-35

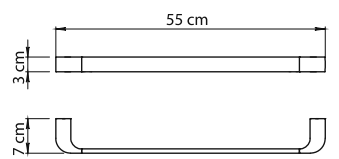

3221-55

Outline.

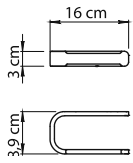

3224

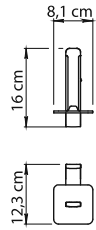

3224-02

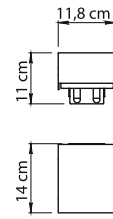

3225

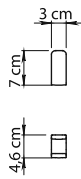

3226

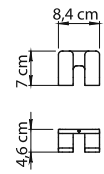

3228

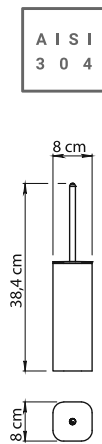

3234

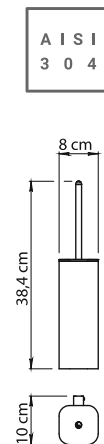

3233-03

SERIE DA MURO . WALL LINES .

TOP DESIGN

Gea.

Realizzata in ottone e alluminio con contenitori in vetro satinato

Made of brass and aluminium with frosted glass containers

Réalisée en laiton et aluminium avec boîtiers en verre satiné

Hergestellt aus Messing und Aluminium mit Behältern aus satiniertem Glas

Realizada en latón y aluminio con contenedores en cristal satinado

Изготовлено из латуни и алюминия с ёмкостями из матового стекла



Con biadesivo
With double sided tape



GARANZIA
WARRANTY



13
Cromato
Chromed

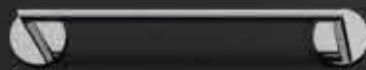

SERIE DA MURO . WALL LINES .

TOP DESIGN

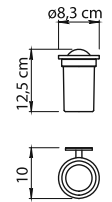
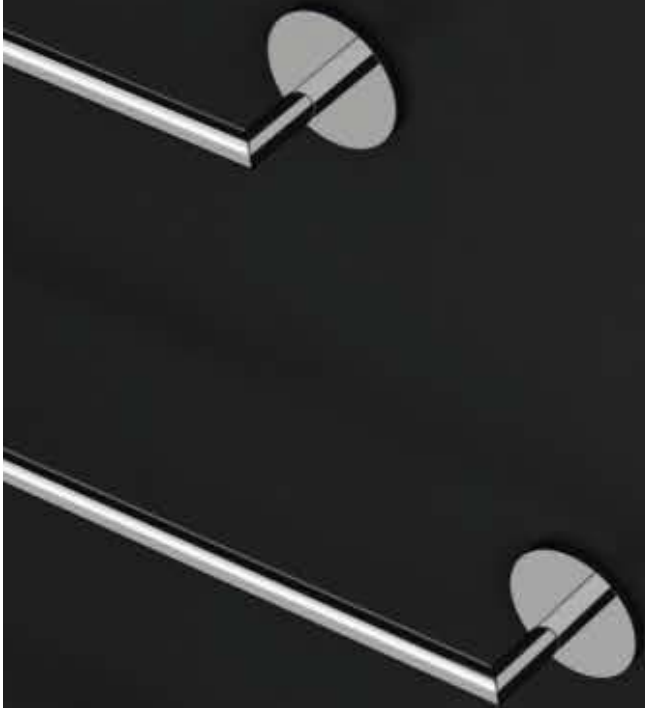

3610

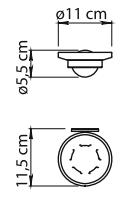

3611

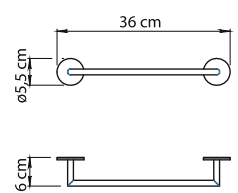

3621-35

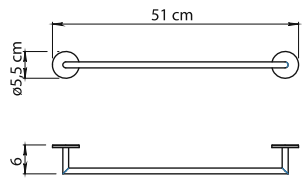

3621-50

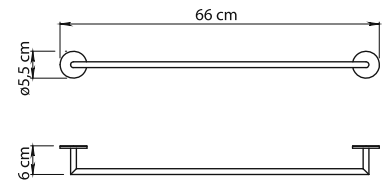

3621-65

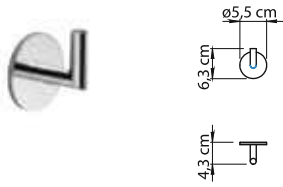

3626

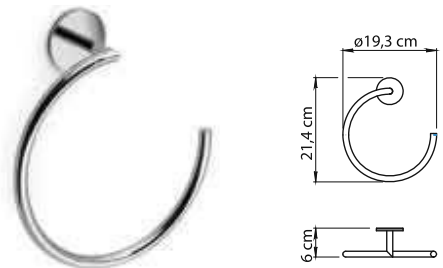

3670

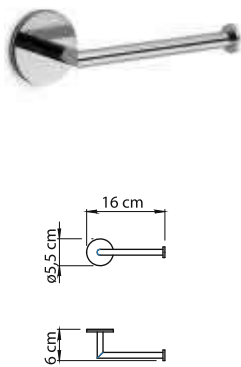

3624



3625

Lounge.

Realizzata in alluminio e Cromall® con contenitori in vetro satinato

Made of aluminium and Cromall® with frosted glass containers

Réalisée en aluminium et Cromall® avec boîtiers en verre satiné

Hergestellt aus Aluminium und Cromall® mit Behältern aus satiniertem Glas

Realizada en aluminio y Cromall® con contenedores en cristal satinado

Изготовлено из латуни и ёмкостями с Cromall® из матового стекла



Con viti

With screws



GARANZIA

WARRANTY



13
Cromato
Chromed



14
Nero matt
Matt black

Lounge.

SERIE DA MURO
Wall series



SERIE DA MURO . WALL LINES .

TOP DESIGN

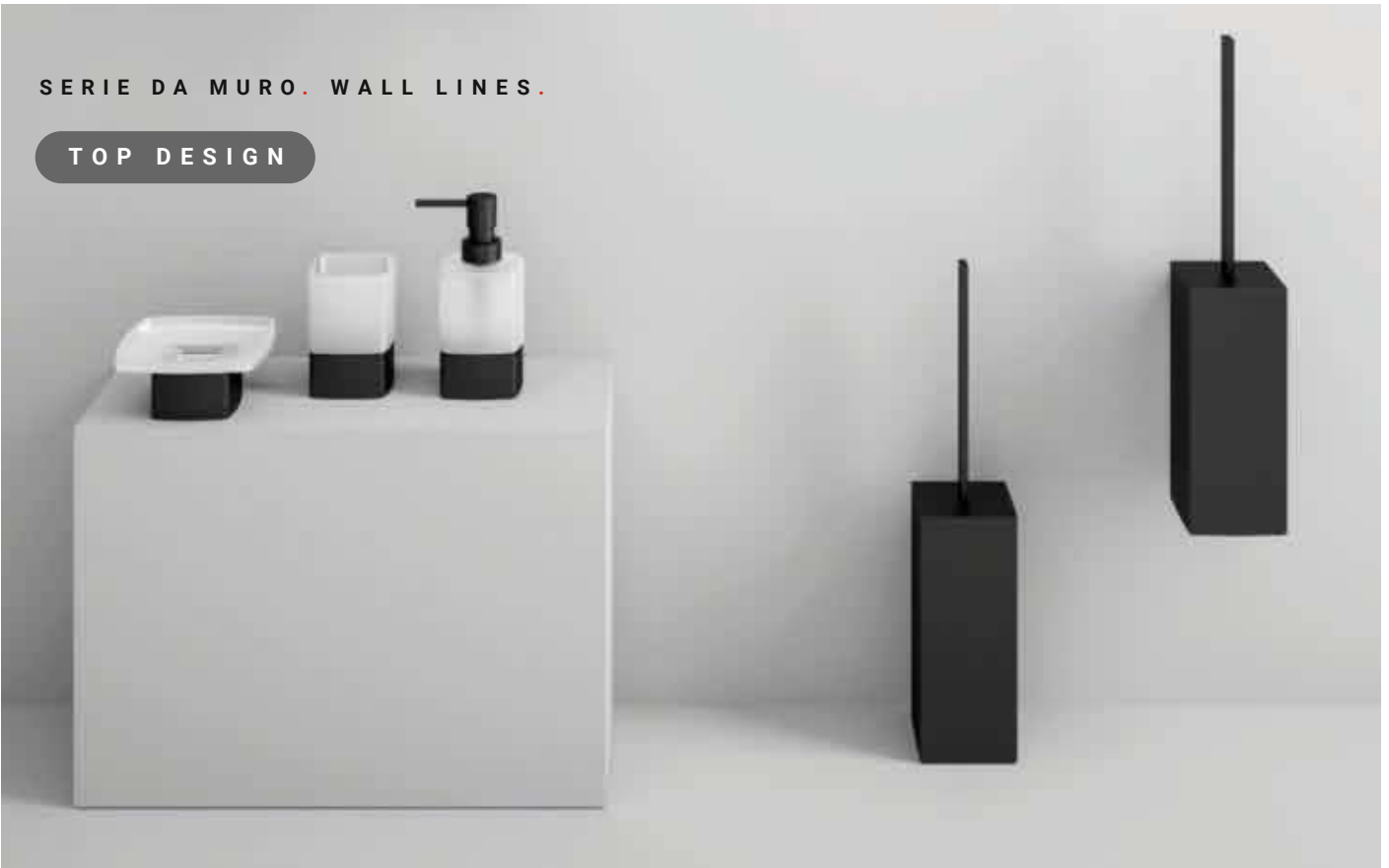

5410



5411



5481

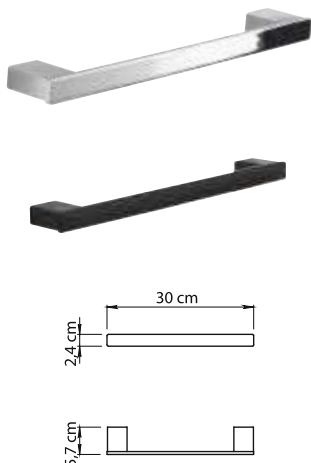

5421-30

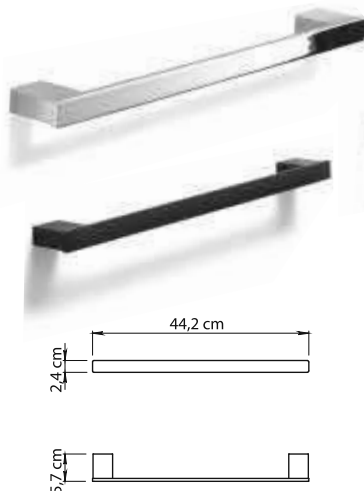

5421-45

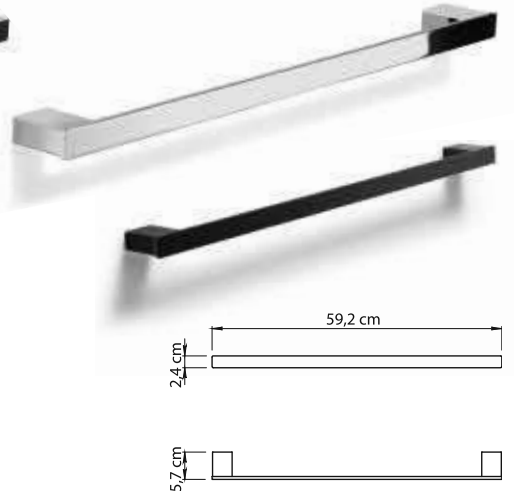

5421-60

TOP DESIGN

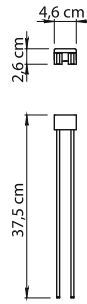

5423

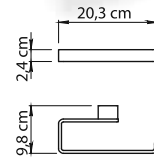
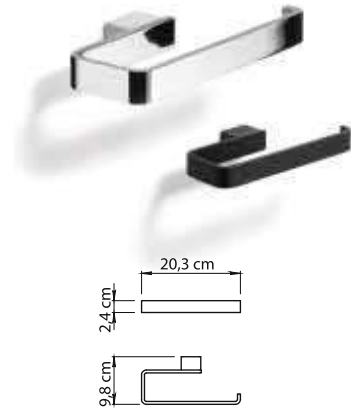

5470

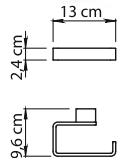

5424

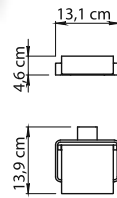

5425

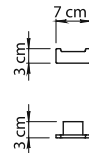

5426

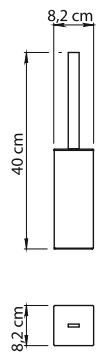

5433

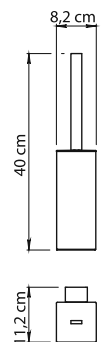

5433-03

Lounge.

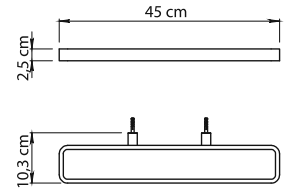

Accessori venduti separatamente

Accessoires supplied separately

5447



S2
Satinato
Satinized



S2
Satinato/cromato
Satinized/chromed



SN
Satinato/nero
Satinized/black

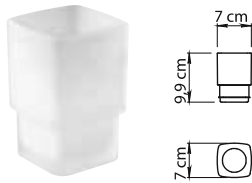

5498

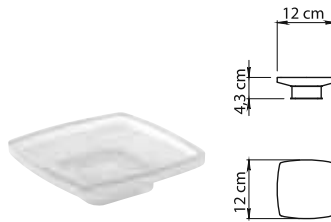

5451



5455



13
Cromato
Chromed



14
Nero matt
Matt black



5498



5451



5455

Samoa.

design Piet Billekens

Realizzata in ottone e Cromall® con contenitori in vetro satinato

Made of brass and Cromall® with frosted glass containers

Réalisée en laiton et Cromall® avec boîtiers en verre satiné

Hergestellt aus Messing und Cromall® mit Behältern aus satiniertem Glas

Realizada en latón y Cromall® con contenedores en cristal satinado

Изготовлено из латуни и Cromall® с ёмкостями из матового стекла



Con viti

With screws



GARANZIA

WARRANTY



13

Cromato
Chromed



14

Nero matt
Matt black

Samoa.



SERIE DA MURO . WALL LINES .

TOP DESIGN

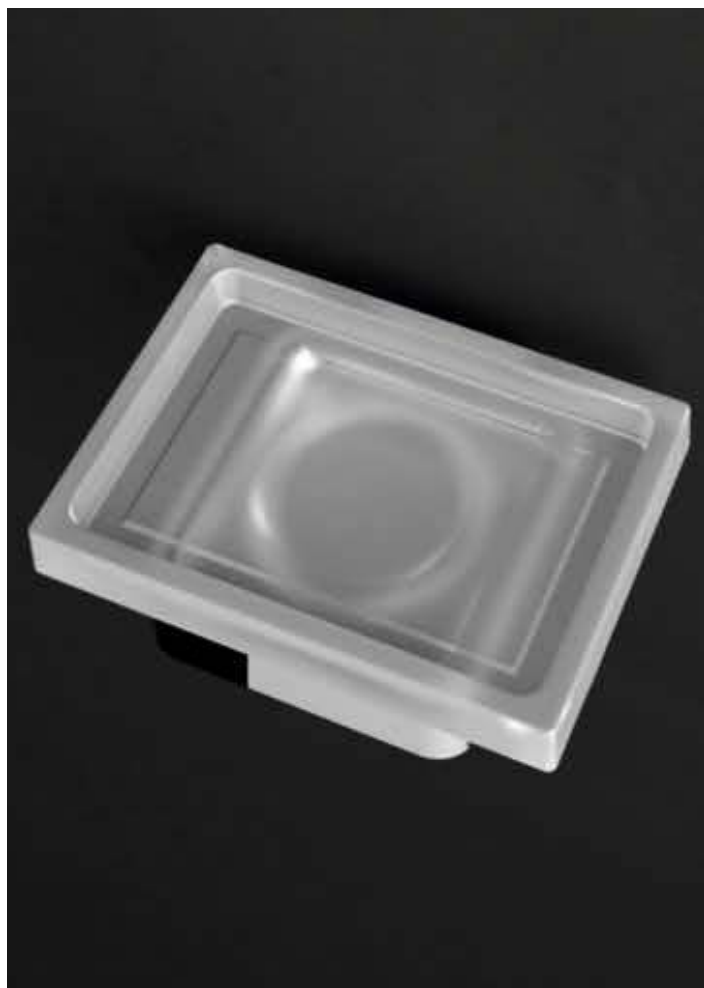
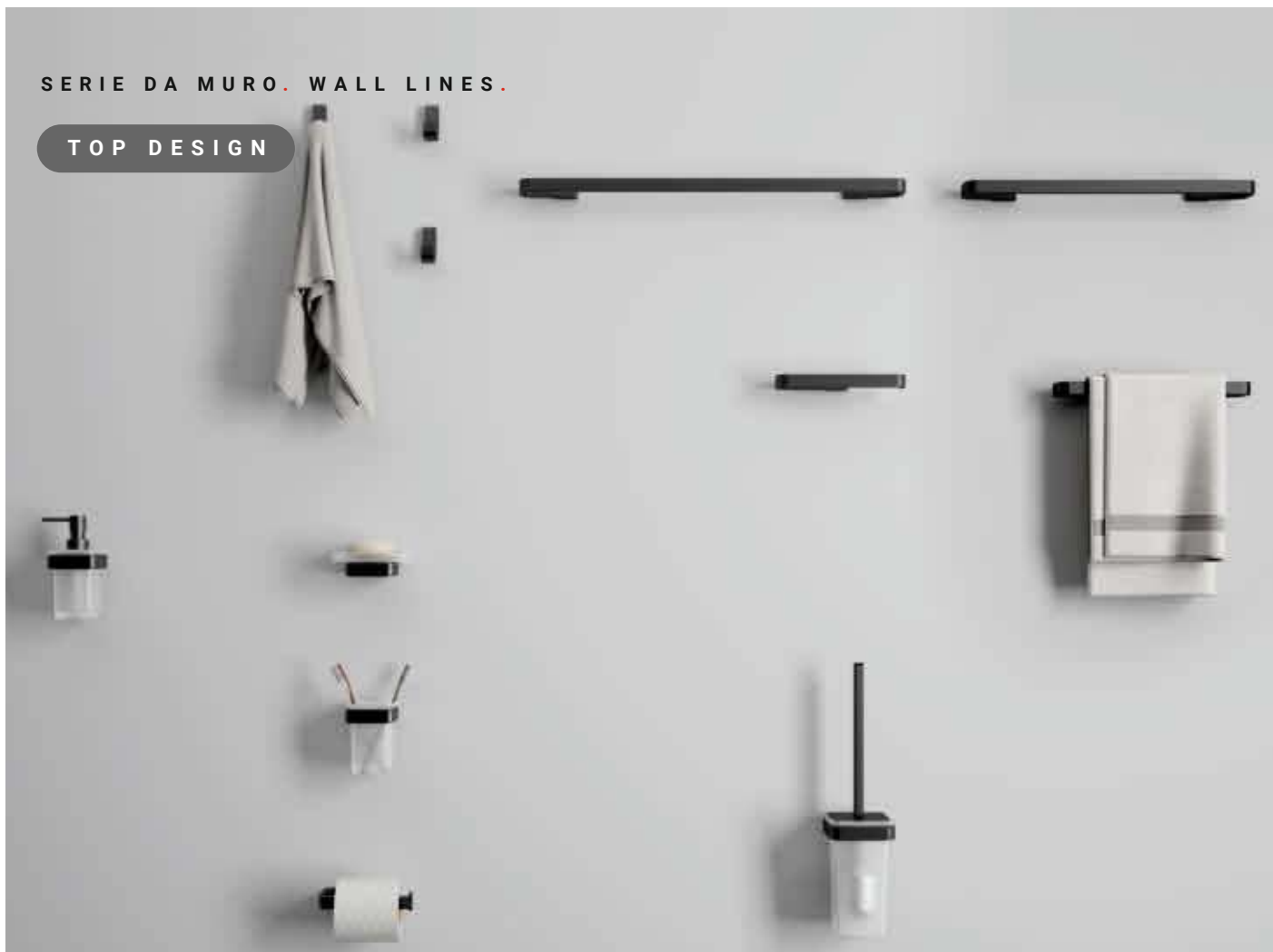

Samoa.

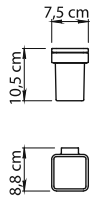

A810

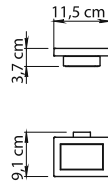

A811

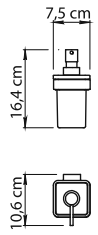

A881

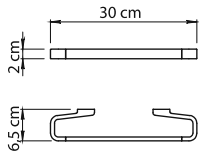

A821-30

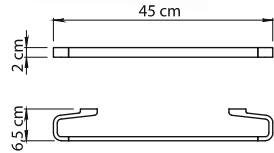

A821-45

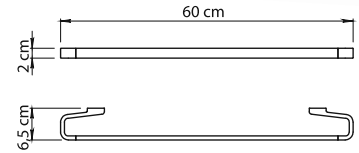

A821-60

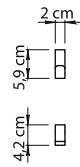

A827

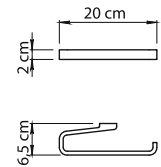

A870

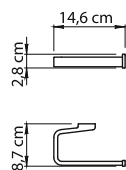

A824

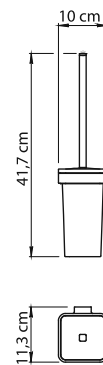

A833-03

Maui.



Realizzata in acciaio inox AISI 304 e Cromall® con contenitori in vetro satinato

Made of AISI 304 stainless steel and Cromall® with frosted glass containers

Réalisée en acier inoxydable AISI 304 et Cromall® avec boîtiers en verre satiné

Hergestellt aus Edelstahl AISI 304 und Cromall® mit Behältern aus satiniertem Glas

Realizada en acero inox AISI 304 y Cromall® con contenedores en cristal satinado

Изготовлено из нержавеющей стали AISI 304 и Cromall® с ёмкостями из матового стекла



Con viti
With screws



GARANZIA
WARRANTY



38
Spazzolato
Brushed

Maui.



SERIE DA MURO . WALL LINES .

TOP DESIGN

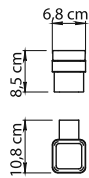

A510

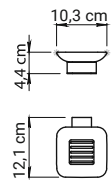

A511

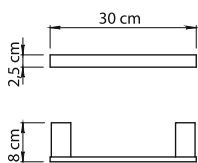

A521-30

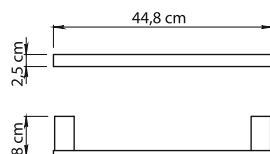

A521-45

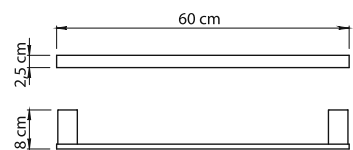

A521-60

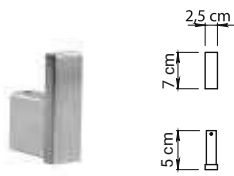

A526



A570



A524

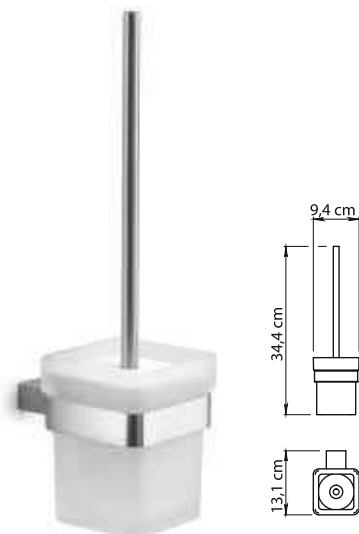

A533-03

Bridge.

design Carlo Martino

Realizzata in ottone, acciaio inox e Cromall®

Made of brass, stainless steel and Cromall®

Réalisée en laiton, acier inoxydable et Cromall®

Hergestellt aus Messing, Edelstahl und Cromall®

Realizada en latón, acero inox y Cromall®

Изготовлено из латуни, нержавеющей стали, Cromall® и матового стекла



Con viti
With screws



GARANZIA
WARRANTY



13
Cromato
Chromed

Bridge.

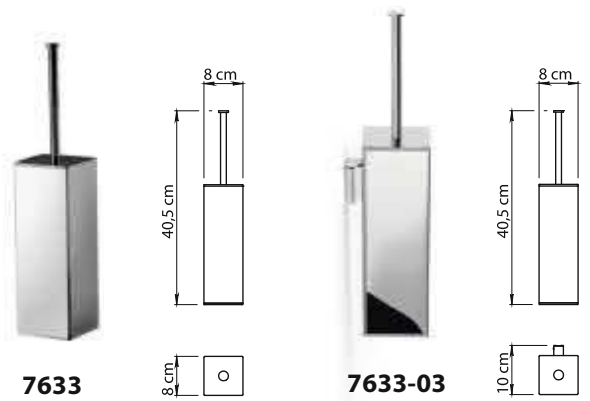
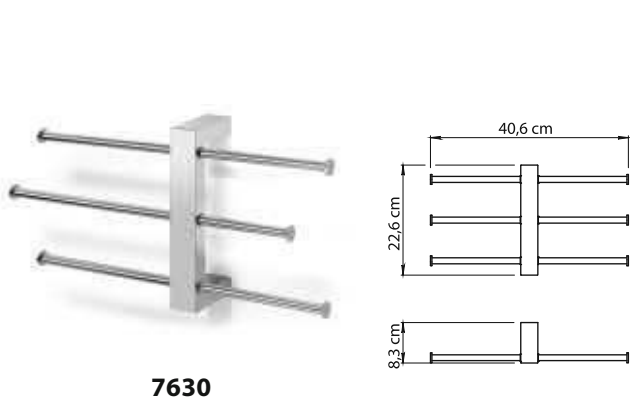
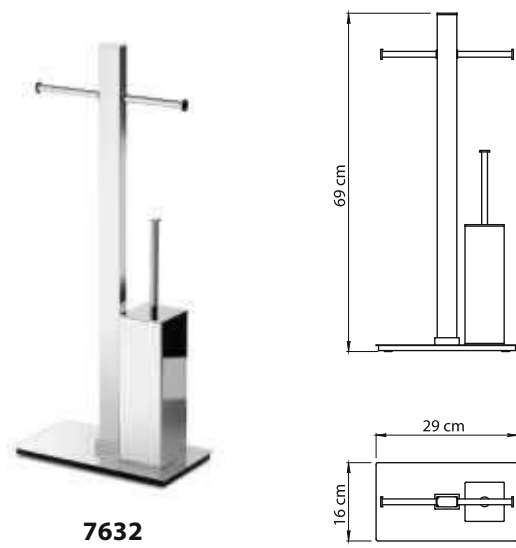
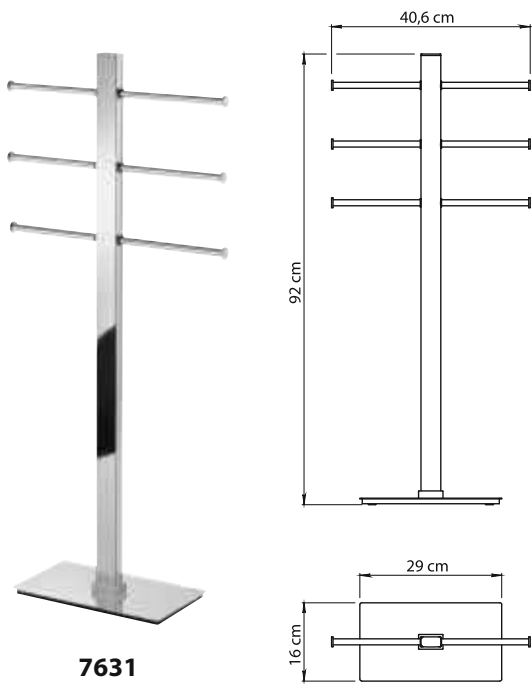
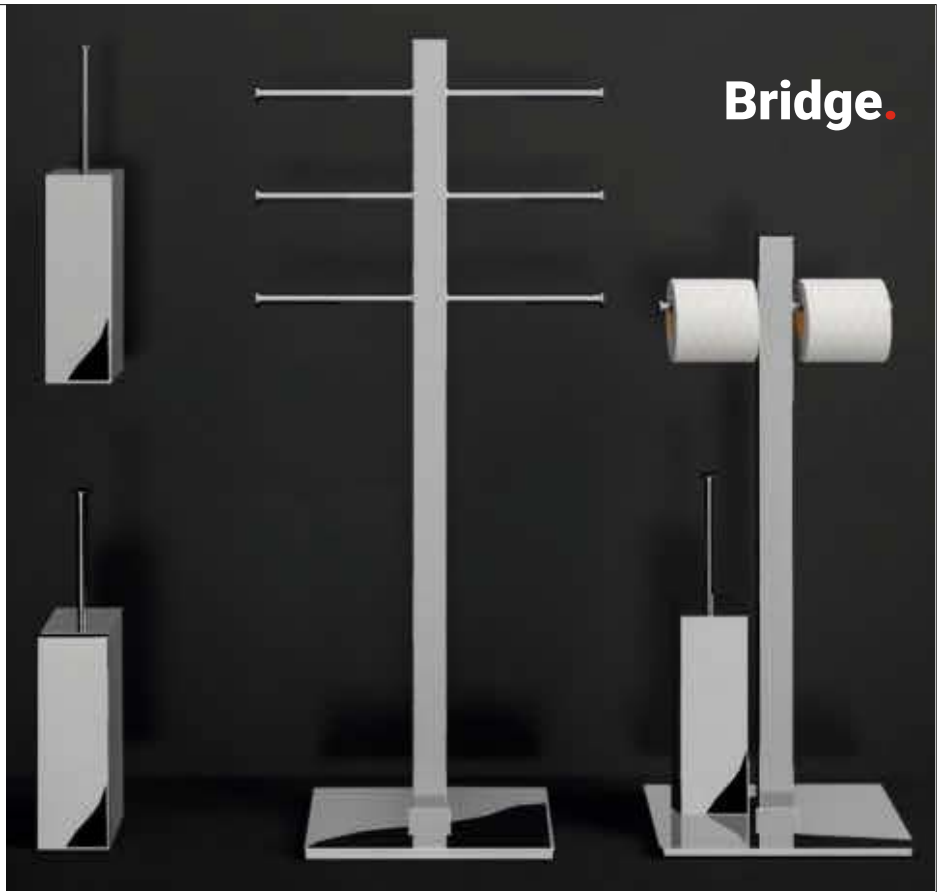

RETAIL

Atena.

Realizzata in acciaio inox e Cromall® con contenitori in vetro satinato

Made of stainless steel and Cromall® with frosted glass containers

Réalisée en acier inoxydable et Cromall® avec boîtiers en verre satiné

Hergestellt aus Edelstahl und Cromall® mit Behältern aus satiniertem Glas

Realizada en acero inoxidable y Cromall® con contenedores en cristal satinado

Изготовлено из нержавеющей стали и Cromall® с ёмкостями из матового

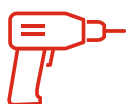

Con viti

With screws



Con colla

With glue

(Venduta a parte
Sold seperately)



GARANZIA

WARRANTY



13
Cromato
Chromed



14
Nero matt
Matt black

Atena.

SERIE DA MURO
Wall series



SERIE DA MURO. WALL LINES.

RETAIL



4410

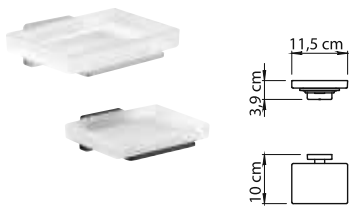

4411

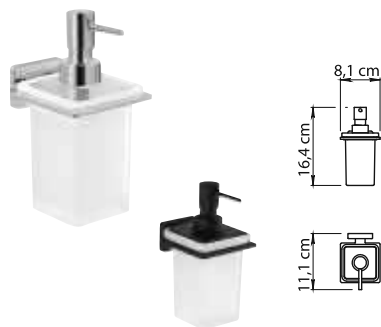

4481

Atena.

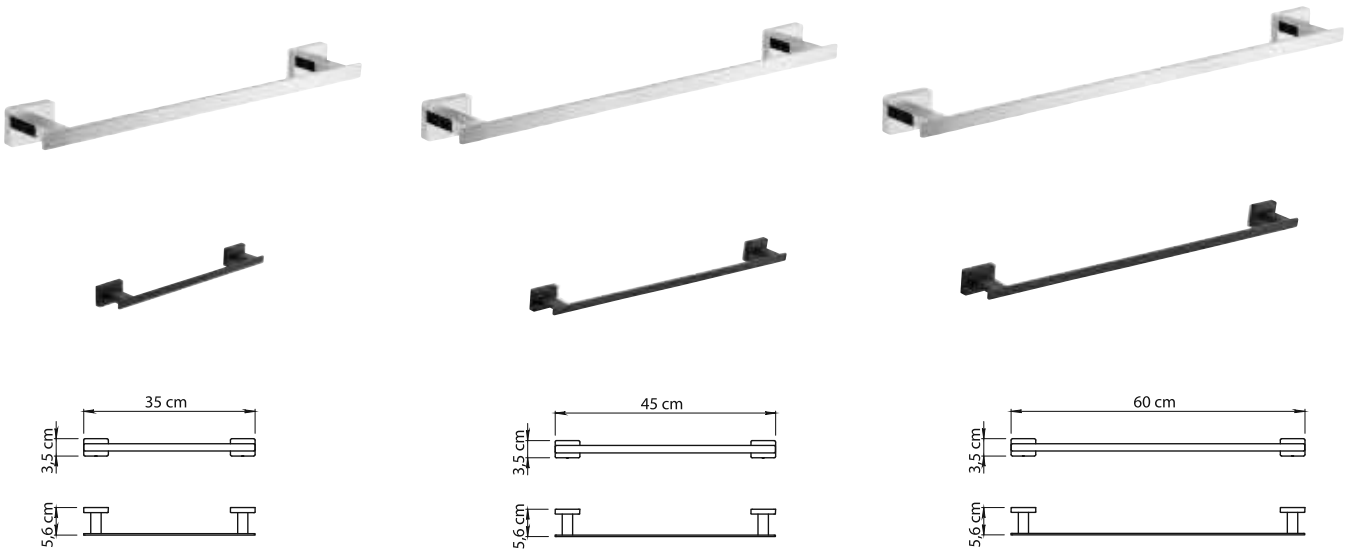

4421-30

4421-45

4421-60

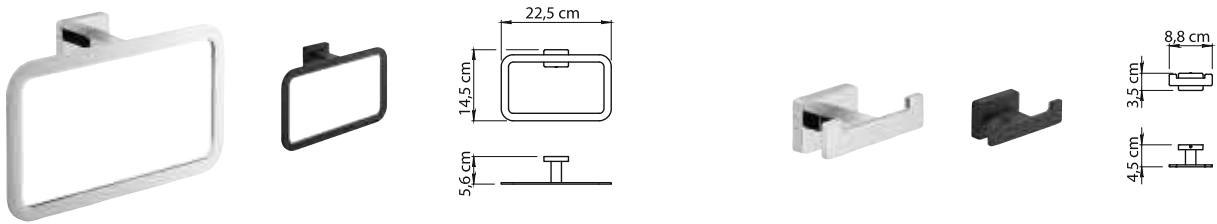

4470

4426

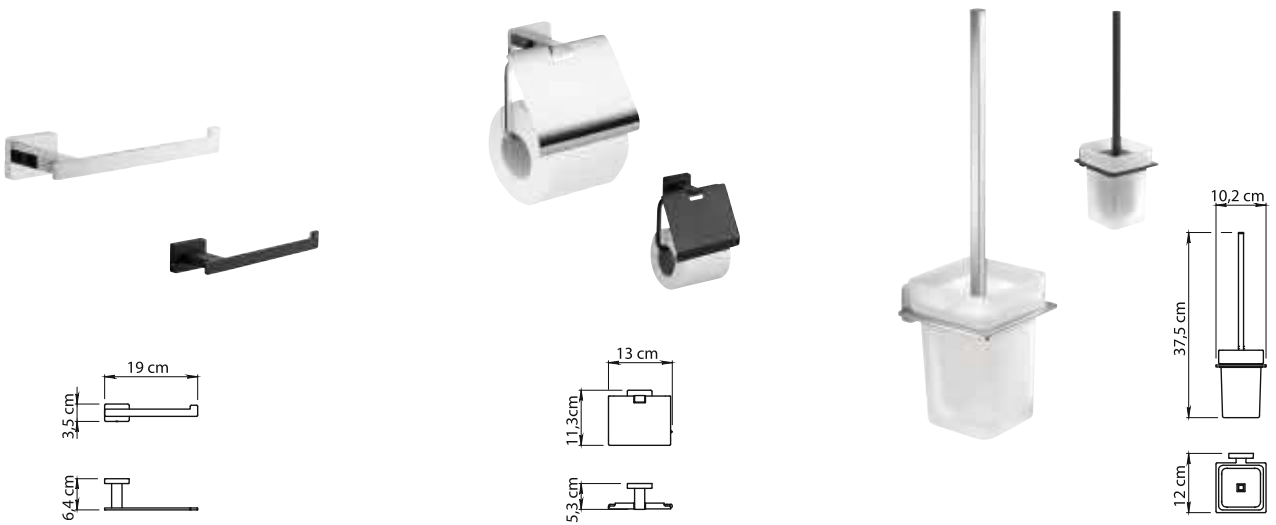

4424

4425

4433-03

RETAIL

Febo.

Realizzata in acciaio inox e Cromall® con contenitori in vetro satinato

Made of stainless steel and Cromall® with frosted glass containers

Réalisée en acier inoxydable et Cromall® avec boîtiers en verre satiné

Hergestellt aus Edelstahl und Cromall® mit Behältern aus satiniertem Glas

Realizada en acero inoxidable y Cromall® con contenedores en cristal satinado

Изготовлено из нержавеющей стали и Cromall® с ёмкостями из матового стекла

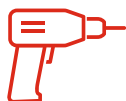

Con viti

With screws



Con colla

With glue



GARANZIA

WARRANTY

(Venduta a parte
Sold seperately)



13

Cromato
Chromed

Febo.

SERIE DA MURO
Wall series



SERIE DA MURO. WALL LINES.

RETAIL

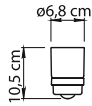

5310

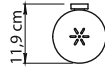
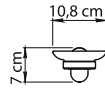

5311

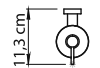
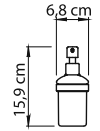

5381

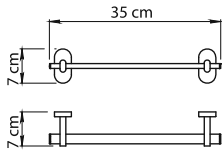

5321-35

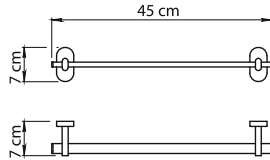

5321-45

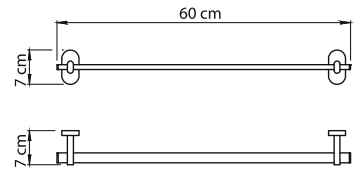

5321-60



Solo con viti
Only with screws

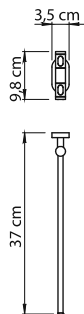

5323

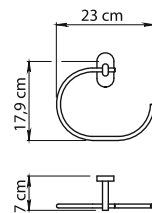

5370

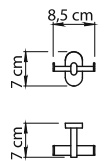
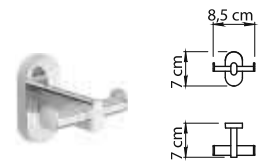

5326

Febo.

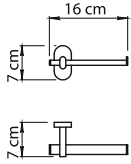

5324

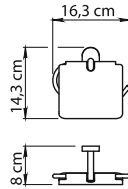

5325

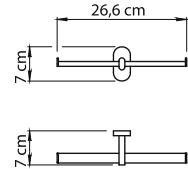

5329



Vetro temperato
Tempered glass



Solo con viti
Only with screws

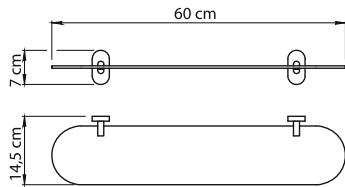

5319-60

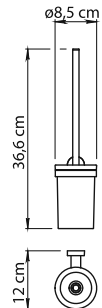
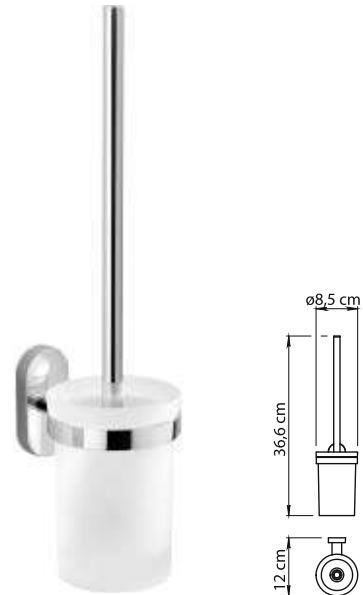

5333-03

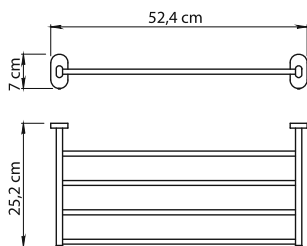

5344

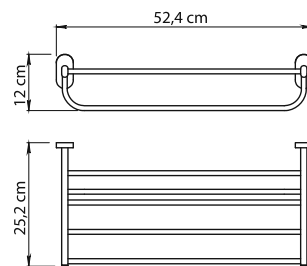
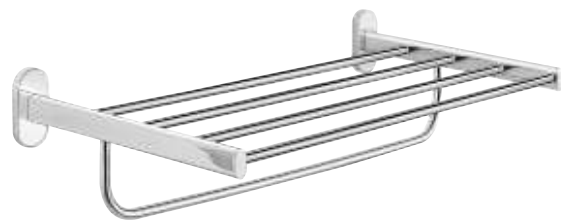

5335



Solo con viti
Only with screws

RETAIL

Eros.

Realizzata in acciaio inox e Cromall® con contenitori in vetro satinato

Made of stainless steel and Cromall® with frosted glass containers

Réalisée en acier inoxydable et Cromall® avec boîtiers en verre satiné

Hergestellt aus Edelstahl und Cromall® mit Behältern aus satiniertem Glas

Realizada en acero inoxidable y Cromall® con contenedores en cristal satinado

Изготовлено из нержавеющей стали и Cromall® с ёмкостями из матового

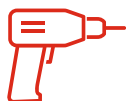

Con viti

With screws



Con colla

With glue

(Venduta a parte
Sold seperately)



GARANZIA

WARRANTY



13
Cromato
Chromed



14
Nero matt
Matt black

Eros.

SERIE DA MURO
Wall series



SERIE DA MURO . WALL LINES .

RETAIL



Eros.

SERIE DA MURO
Wall series



SERIE DA MURO. WALL LINES.

RETAIL

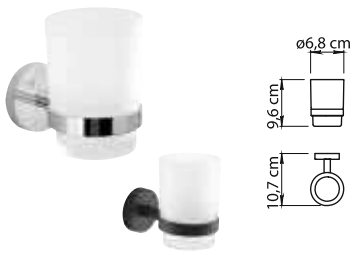
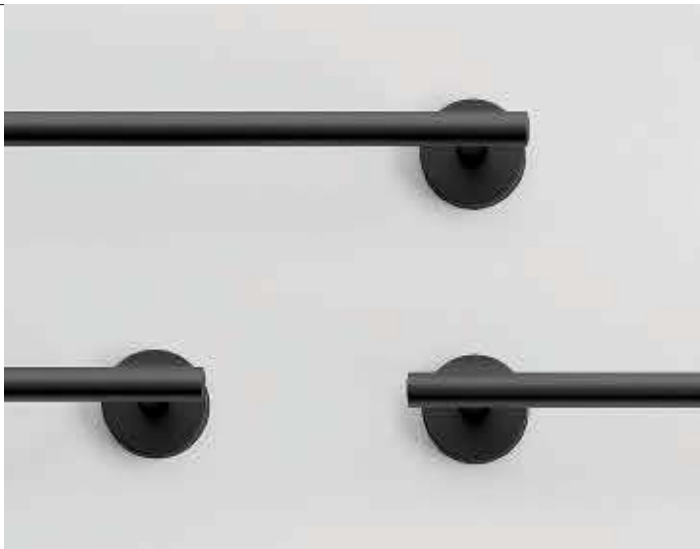

2310

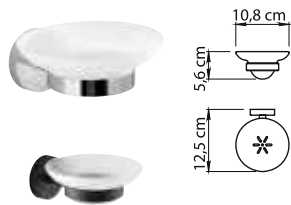

2311



2381

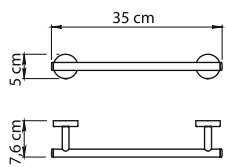

2321-35

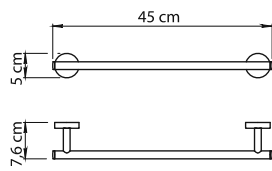

2321-45

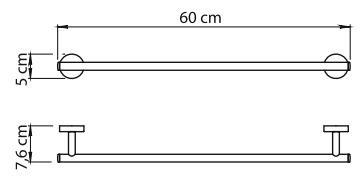

2321-60



Solo con viti
Only with screws



2323

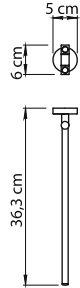

2370

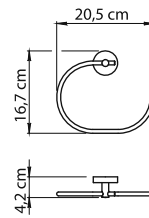

2326

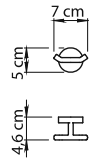

2324

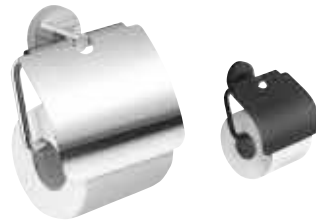
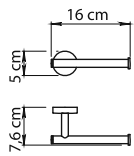

2325

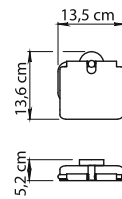

2355

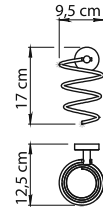

2319-60



Vetro temperato
Tempered glass



Solo con viti
Only with screws

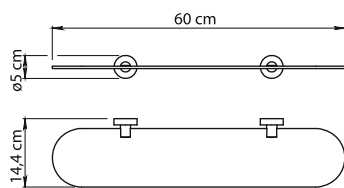

2333-03

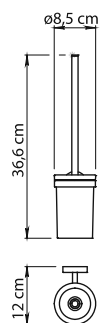

RETAIL

Vermont Pro.

Realizzata in acciaio inox e Cromall® con contenitori in vetro satinato

Made of stainless steel and Cromall® with frosted glass containers

Réalisée en acier inoxydable et Cromall® avec boîtiers en verre satiné

Hergestellt aus Edelstahl und Cromall® mit Behältern aus satiniertem Glas

Realizada en acero inoxidable y Cromall® con contenedores en cristal satinado

Изготовлено из нержавеющей стали и Cromall® с ёмкостями из матового стекла

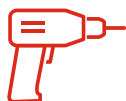

Con viti

With screws



Con colla

With glue



GARANZIA

WARRANTY

(Venduta a parte
Sold seperately)



13

Cromato
Chromed

Vermont Pro.



SERIE DA MURO. WALL LINES.

RETAIL

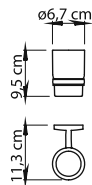

4210

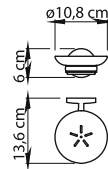

4211

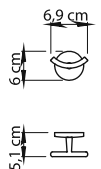

4226

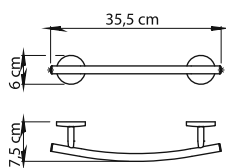

4221-35

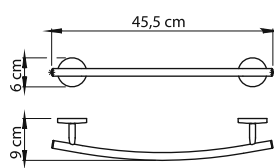

4221-45

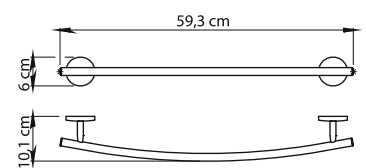

4221-60



Solo con viti
Only with screws



4223

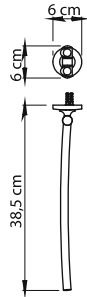

4270

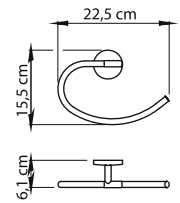

4224

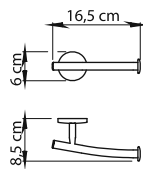

4234

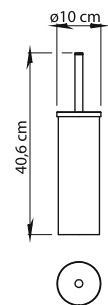

Project.

Realizzata in acciaio inox AISI 304 con contenitori in vetro satinato

Made of AISI 304 stainless steel with frosted glass containers

Réalisée en acier inoxydable AISI 304 avec boîtiers en verre satiné

Hergestellt aus Edelstahl AISI 304 mit Behältern aus satiniertem Glas

Realizada en acero inox AISI 304 con contenedores en cristal satinado

Изготовлено из нержавеющей стали AISI 304 с ёмкостями из матового стекла

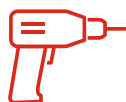

Con viti
With screws



GARANZIA
WARRANTY

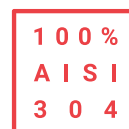

13
Lucido
Polished



38
Spazzolato
Brushed

Project.

SERIE DA MURO
Wall series



SERIE DA MURO . WALL LINES .

GEDY



CONFORME / IN CONFORMITY WITH UNI11064:2003

KG 180

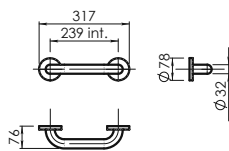

5020-24

KG 160

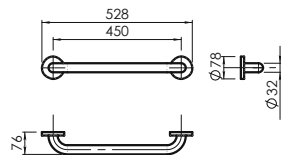

5020-45

KG 160

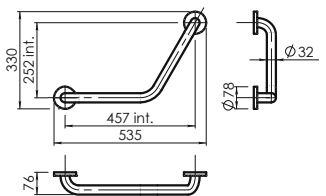

5022

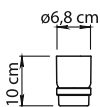

5010

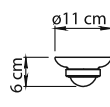

5011

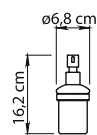

5081

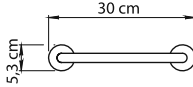

5021-30

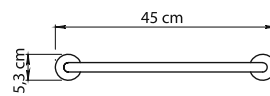

5021-45

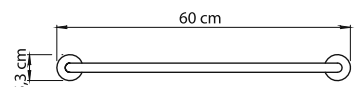

5021-60

Project.

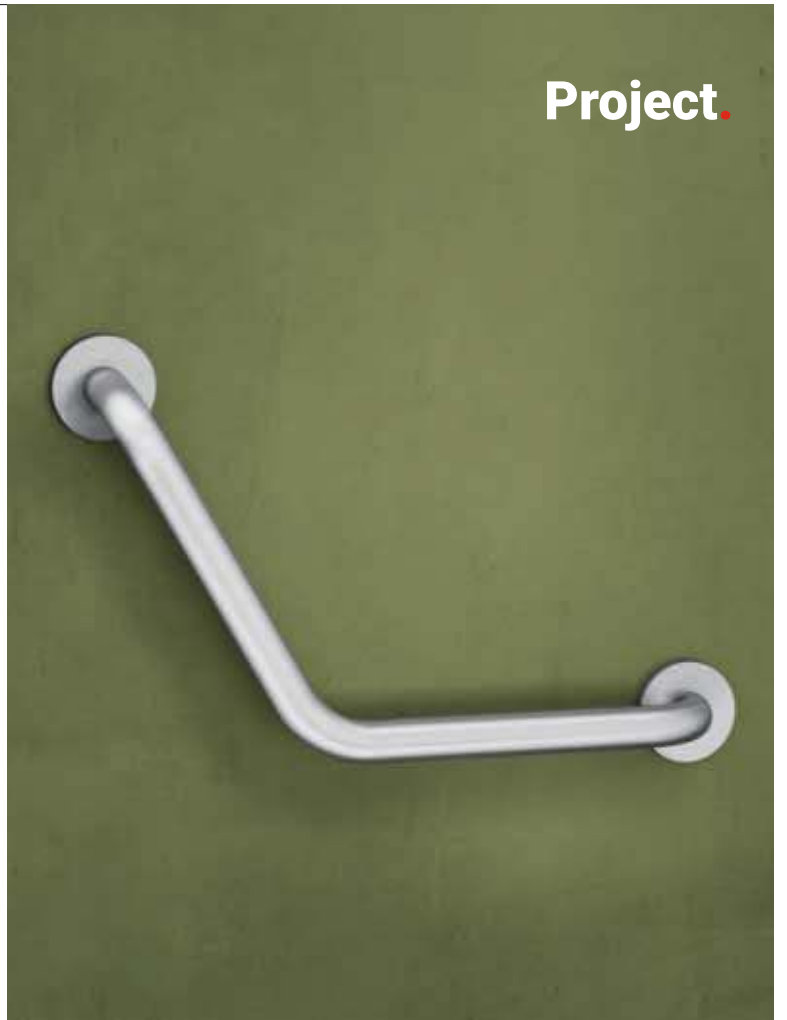

NEW

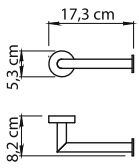
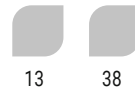

5024

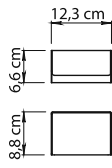

5025

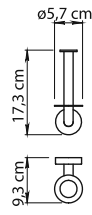

5024-02

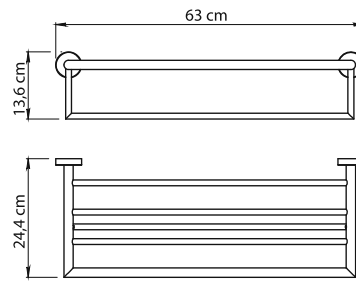

5044

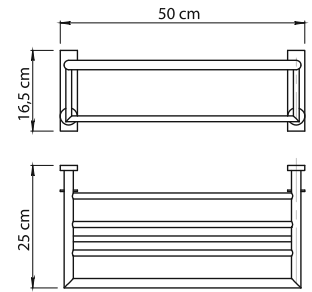

5035

13
solo - only

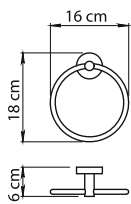

5070

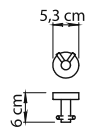

5026

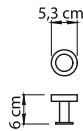

5027

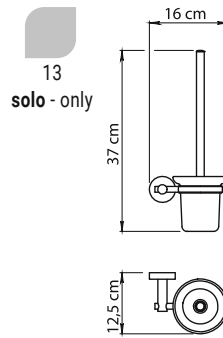

5033-03

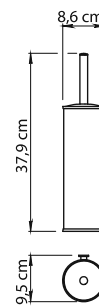

5034-03

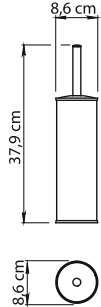

5034

GEDY

Kent.

Realizzata in ottone e Cromall® con contenitori in vetro satinato

Made of brass and Cromall® with frosted glass containers

Réalisée en laiton et Cromall® avec boîtiers en verre satiné

Hergestellt aus Messing und Cromall® mit Behältern aus satiniertem Glas

Realizada en latón y Cromall® con contenedores en cristal satinado

Изготовлено из латуни и Cromall® с ёмкостями из матового стекла

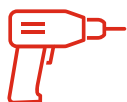

Con viti

With screws



GARANZIA

WARRANTY



13
Cromato
Chromed

Kent.

SERIE DA MURO
Wall series



SERIE DA MURO . WALL LINES .

GEDY

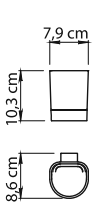

5510

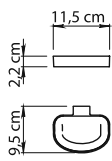

5511

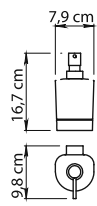

5581

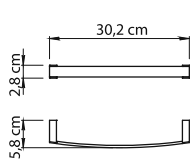

5521-30

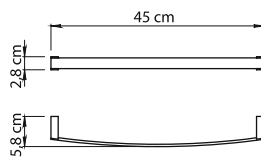

5521-45

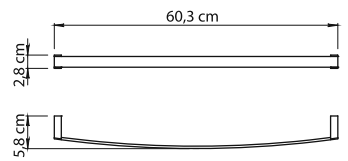

5521-60

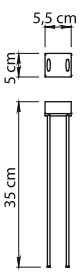
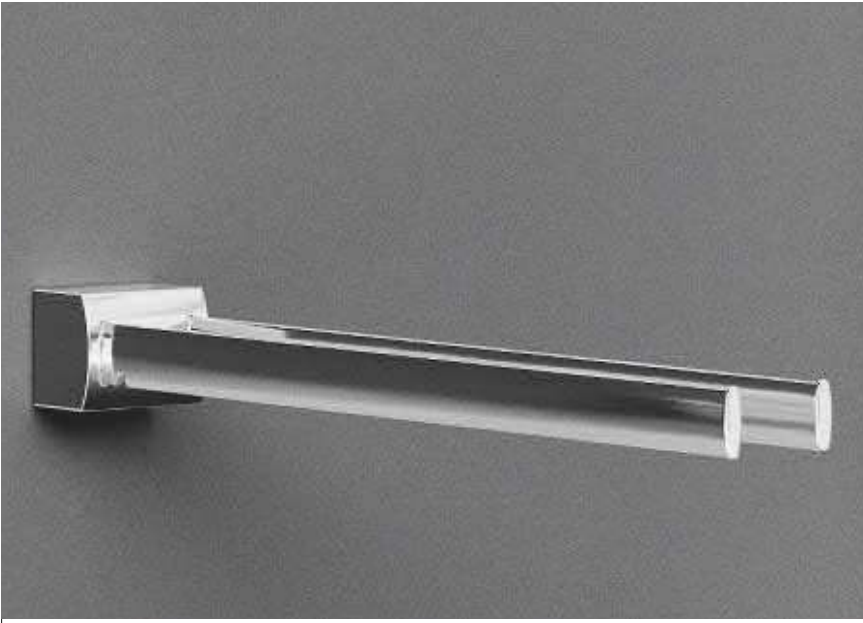

5522

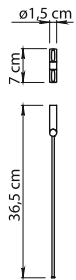

5523

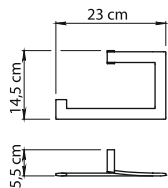

5570

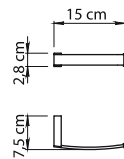

5524

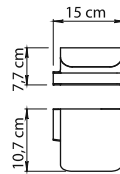

5525

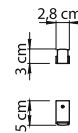

5527

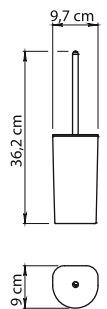

5533

Glamour.

design Piet Billekens

Realizzata in ottone e Cromall® con contenitori in vetro satinato

Made of brass and Cromall® with frosted glass containers

Réalisée en laiton et Cromall® avec boîtiers en verre satiné

Hergestellt aus Messing und Cromall® mit Behältern aus satiniertem Glas

Realizada en latón y Cromall® con contenedores en cristal satinado

Изготовлено из латуни и Cromall® с ёмкостями из матового стекла



Con viti
With screws



GARANZIA
WARRANTY



13
Cromato
Chromed

Glamour.

SERIE DA MURO
Wall series



SERIE DA MURO. WALL LINES.

GEDY

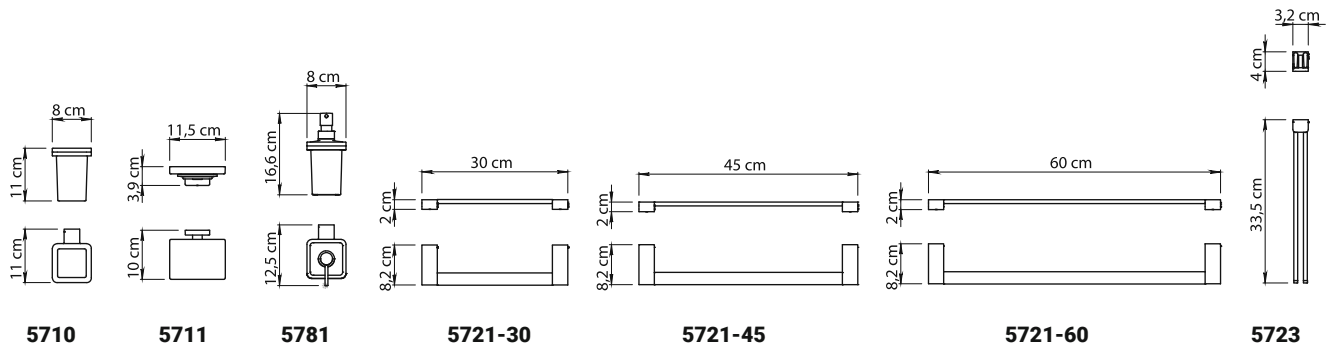
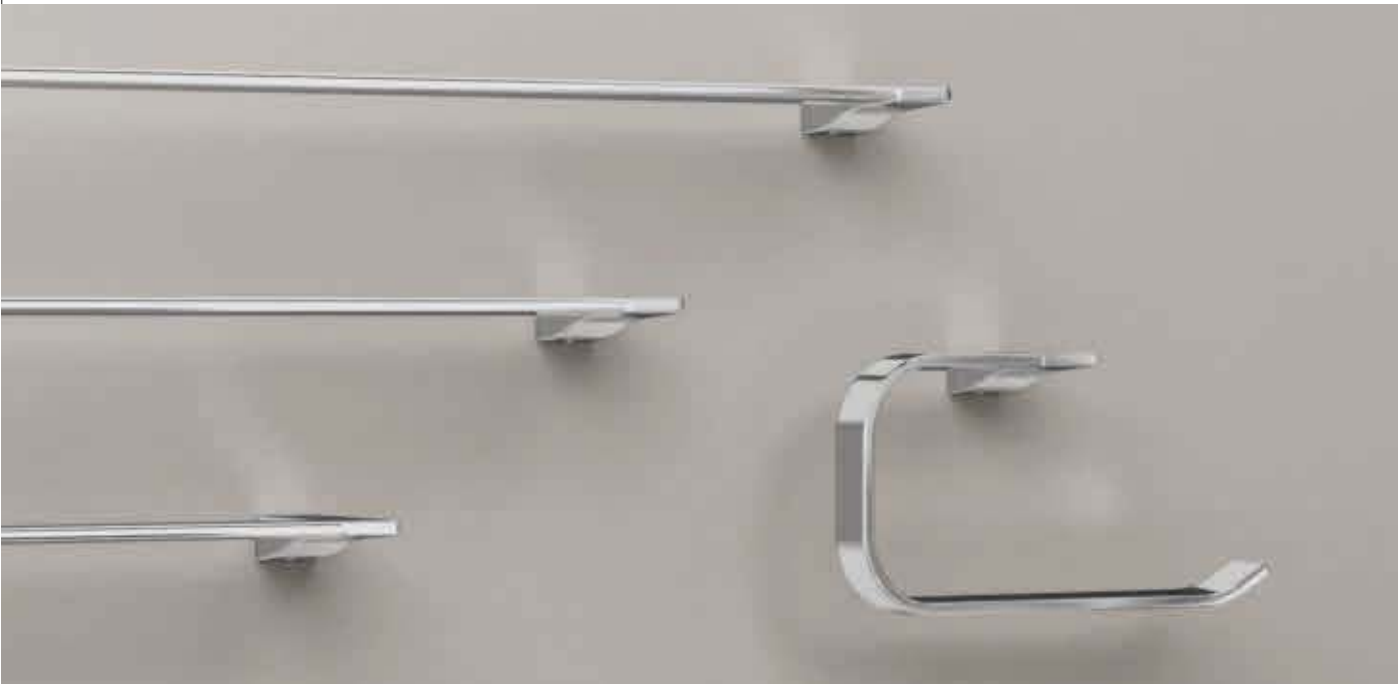



Vetro temperato
Tempered glass

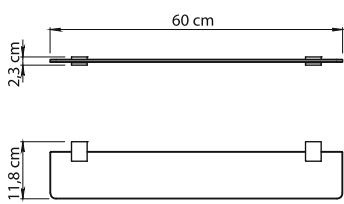

5719-60

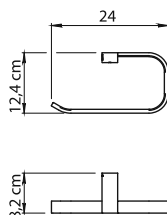

5770

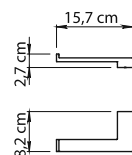

5724

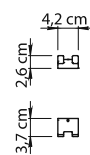

5726

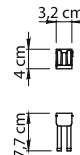

5728

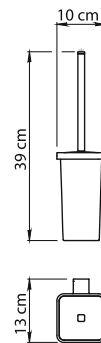

5733-03

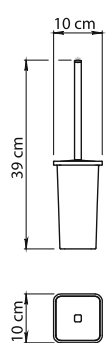

5733

GEDY

Pirenei.

Realizzata in ottone e Cromall® con contenitori in vetro satinato

Made of brass and Cromall® with frosted glass containers

Réalisée en laiton et Cromall® avec boîtiers en verre satiné

Hergestellt aus Messing und Cromall® mit Behältern aus satiniertem Glas

Realizada en latón y Cromall® con contenedores en cristal satinado

Изготовлено из латуни и Cromall® с ёмкостями из матового стекла



Con viti
With screws



GARANZIA
WARRANTY



02
Bianco matt
Matt white



13
Cromato
Chromed



14
Nero matt
Matt black



38
Spazzolato
Brushed



87
Oro
Gold



88
Oro matt
Matt gold

TRATTAMENTO PVD
PVD PLATED

Pirenei.

SERIE DA MURO
Wall series



SERIE DA MURO. WALL LINES.

GEDY



Pirenei.

SERIE DA MURO
Wall series



SERIE DA MURO . WALL LINES .

GEDY



Pirenei.

SERIE DA MURO
Wall series



GEDY

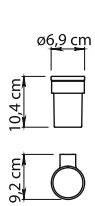

PI10

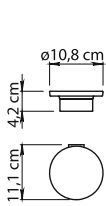

PI11

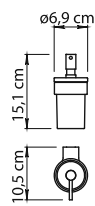

PI81

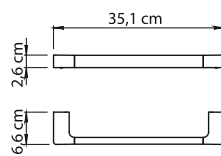

PI21-35

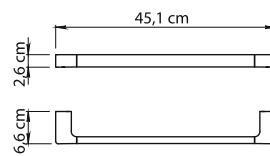

PI21-45

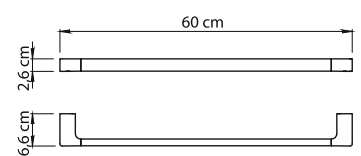

PI21-60

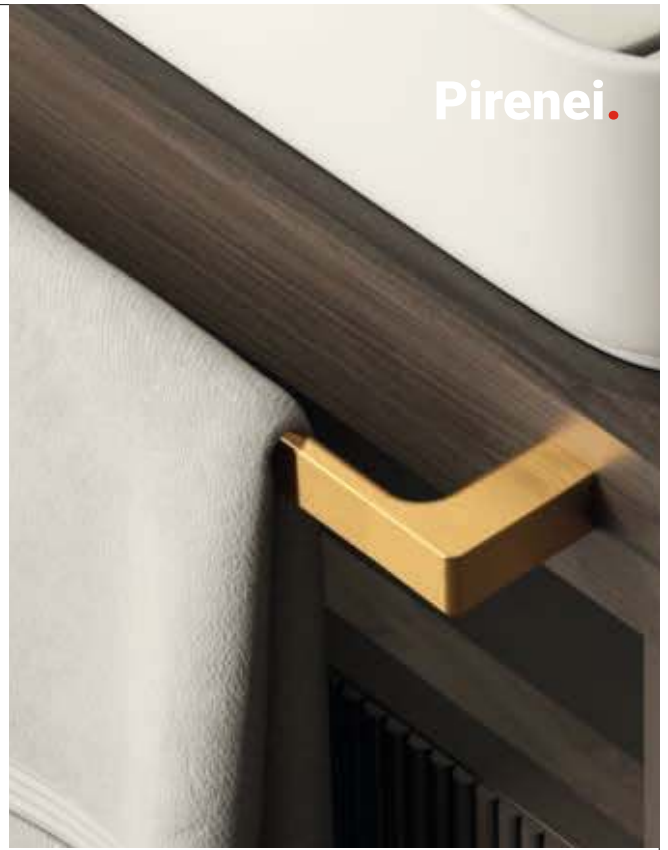

Pirenei.



13 - 02 - 14
*solo - only

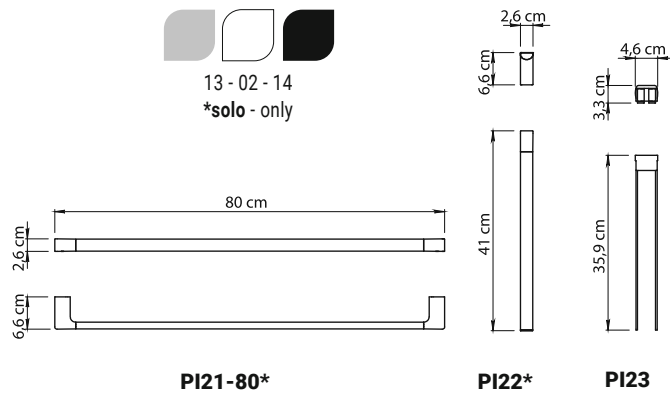

Kansas.

Realizzata in acciaio inox e Cromall® con contenitori in vetro satinato o acciaio inox

Made of stainless steel and Cromall® with frosted glass containers or stainless steel

Réalisée en acier inoxydable et Cromall® avec boîtiers en verre satiné ou acier inoxydable

Hergestellt aus Edelstahl und Cromall® mit Behältern aus satiniertem Glas oder Edelstahl

Realizada en acero inoxidable y Cromall® con contenedores en cristal satinado o acero inoxidable

Изготовлено из нержавеющей стали и Cromall® с ёмкостями из матового стекла или нержавеющей стали

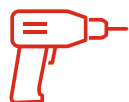

Con viti
With screws



GARANZIA
WARRANTY



13
Cromato
Chromed

Kansas.

SERIE DA MURO
Wall series



GEDY

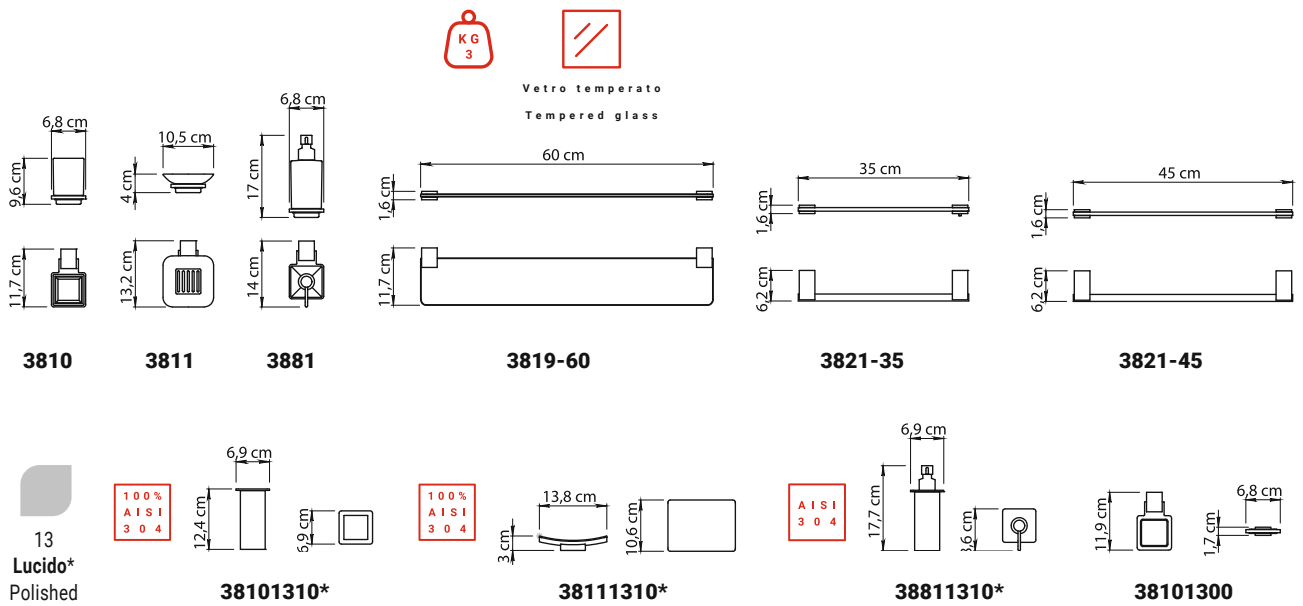
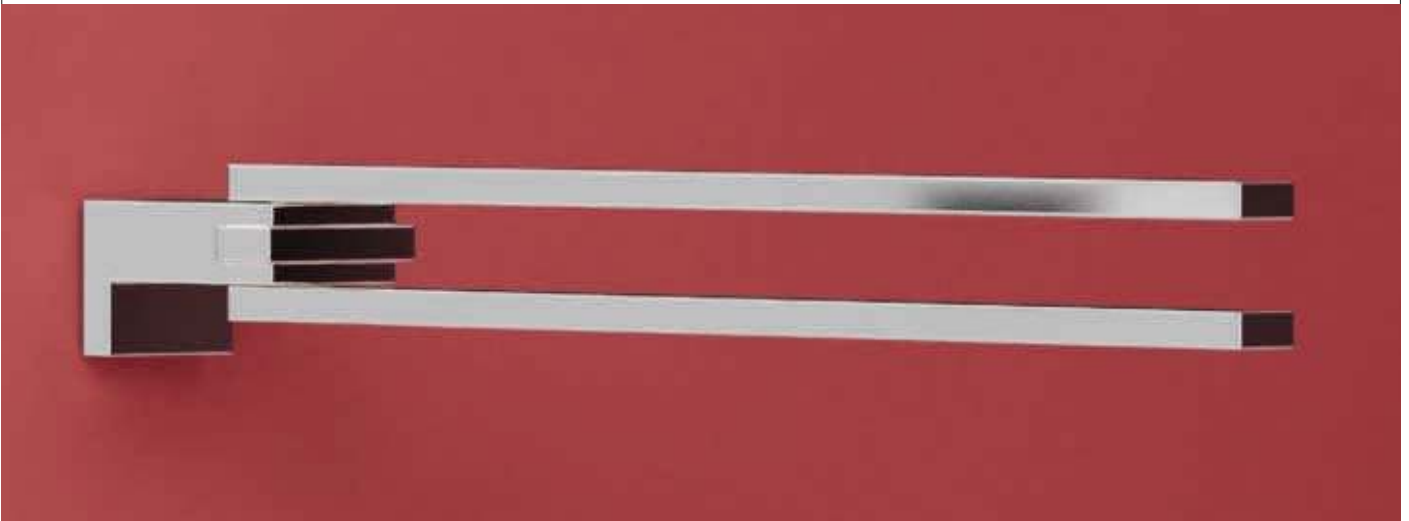

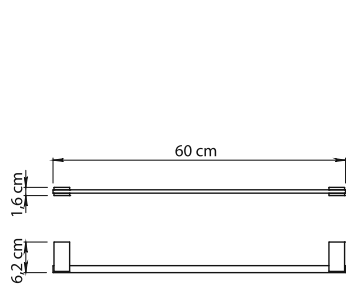

3821-60

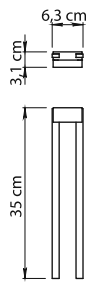

3822

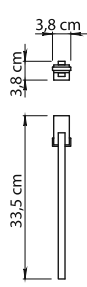

3823

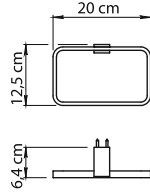

3870

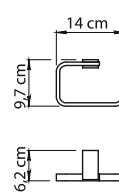

3824

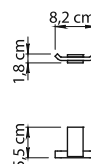

3826

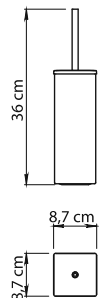

3833

13
Lucido
Polished

2
YEARS
GARANZIA
WARRANTY

GEDY

Gran Torino.

Realizzata in acciaio inox, ottone e Cromall® con contenitori in metacrilato trasparente

Made of stainless steel, brass and Cromall® with transparent methacrylate containers

Réalisée en acier inoxydable, laiton et Cromall® avec boîtiers en méthacrylate transparent

Hergestellt aus Edelstahl, Messing und Cromall® mit durchsichtigen Behältern aus Methacrylat

Realizada en acero inox, latón y Cromall® con contenedores en metacrilato transparente

Изготовлено из нержавеющей стали, латуни и Cromall® с контейнерами

из прозрачного метакрилата

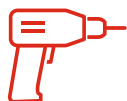

Con viti

With screws



GARANZIA
WARRANTY



84
Nero lucido
Mirror black

TRATTAMENTO PVD
PVD PLATED

Gran Torino.

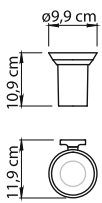

GT10

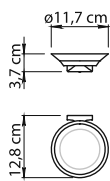

GT11

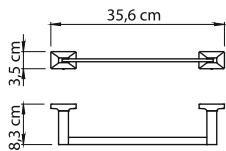

GT21-30

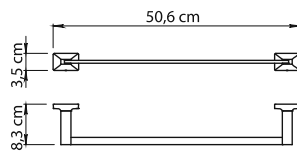

GT21-45

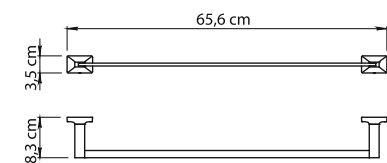

GT21-60

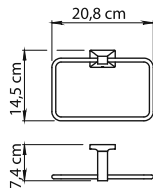

GT70

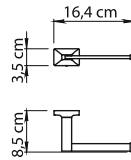

GT24



GT26

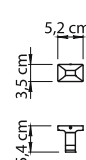

GT27

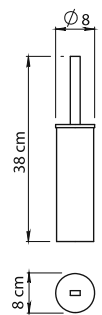

GT33

Maine.

Realizzata in acciaio inox e Cromall® con contenitori in vetro satinato

Made of stainless steel and Cromall® with frosted glass containers

Réalisée en acier inoxydable et Cromall® avec boîtiers en verre satiné

Hergestellt aus Edelstahl und Cromall® mit Behältern aus satiniertem Glas

Realizada en acero inoxidable y Cromall® con contenedores en cristal satinado

Изготовлено из нержавеющей стали и Cromall® с ёмкостями из матового стекла

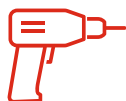

Con viti
With screws



Con colla
With glue



Gira la placca
come vuoi

Turn the plate



GARANZIA
WARRANTY

(Venduta a parte
Sold separately)



13
Cromato
Chromed

Maine.

SERIE DA MURO
Wall series



SERIE DA MURO . WALL LINES .

GEDY

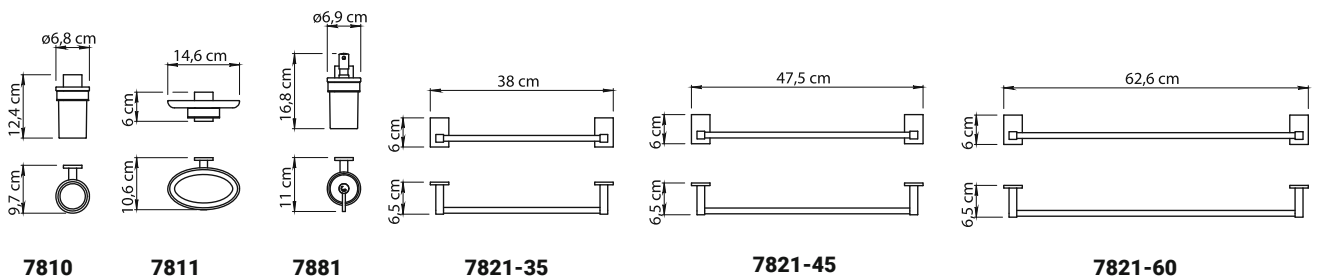
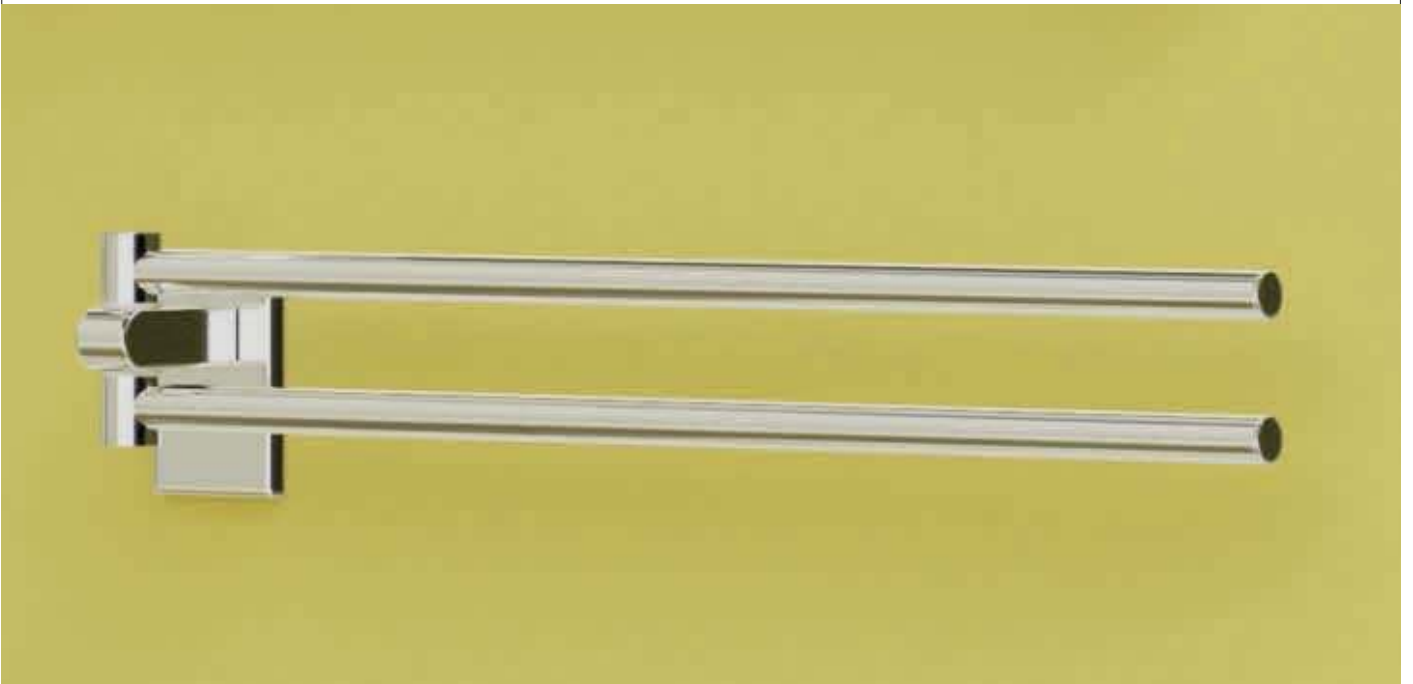



Maine.



Vetro temperato Solo con viti
Tempered glass Only with screws

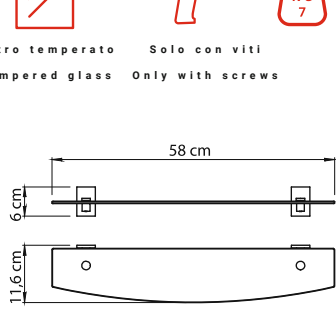

7819-60

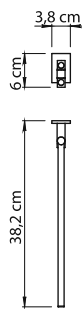

7823

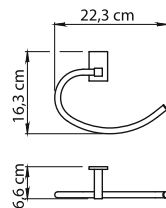

7870

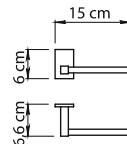

7824

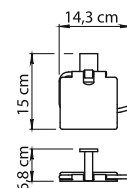

7825

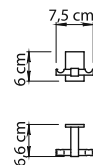

7826

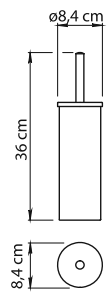

7833

Bernina.

Realizzata in acciaio inox e Cromall® con contenitori in vetro satinato

Made of stainless steel and Cromall® with frosted glass containers

Réalisée en acier inoxydable et Cromall® avec boîtiers en verre satiné

Hergestellt aus Edelstahl und Cromall® mit Behältern aus satiniertem Glas

Realizada en acero inoxidable y Cromall® con contenedores en cristal satinado

Изготовлено из нержавеющей стали и Cromall® с ёмкостями из матового стекла

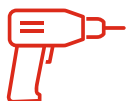

Con viti

With screws



Con colla

With glue



GARANZIA
WARRANTY

(Venduta a parte
Sold seperately)



13
Cromato
Chromed

Bernina.

SERIE DA MURO
Wall series



SERIE DA MURO . WALL LINES .

GEDY

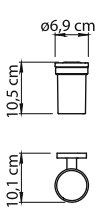
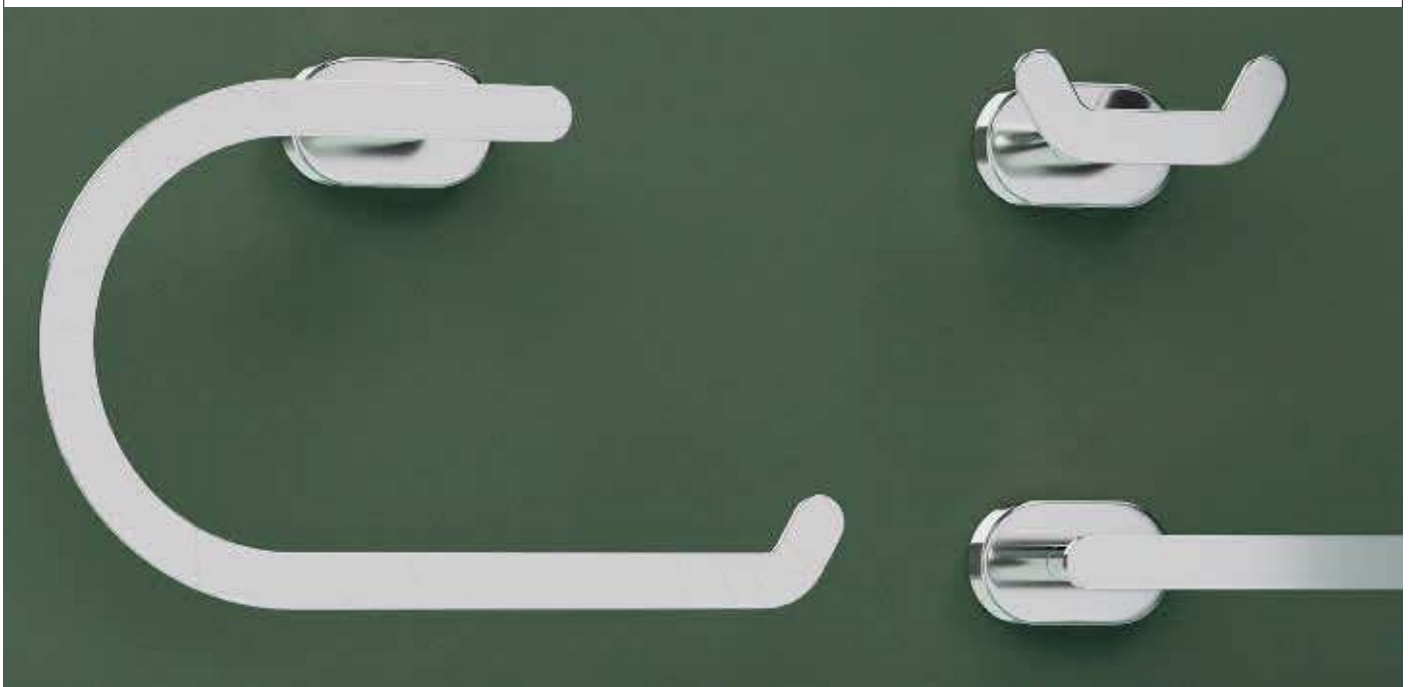
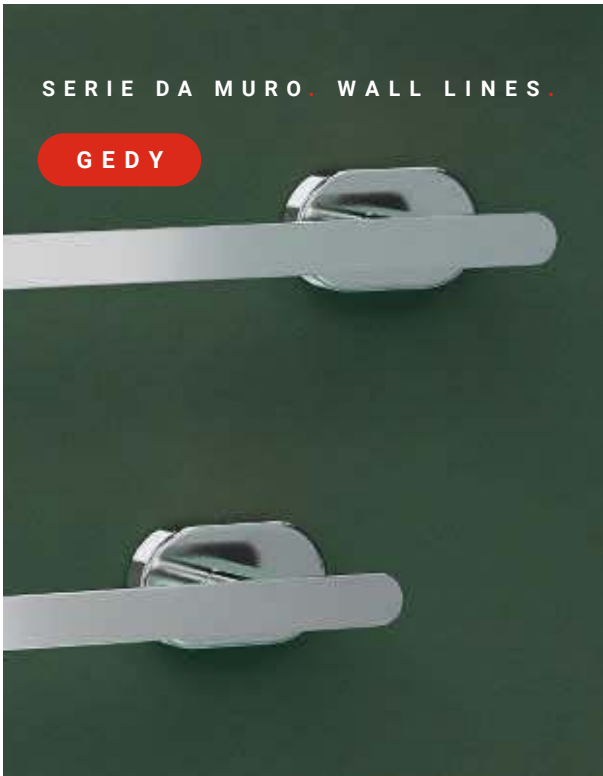

BE10

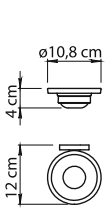

BE11

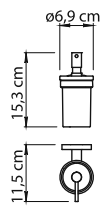

BE81

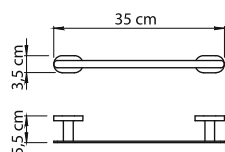

BE21-35

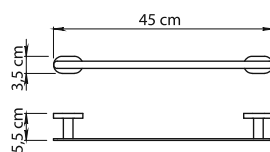

BE21-45

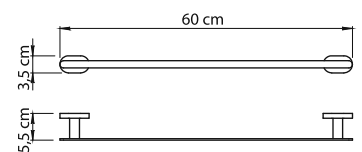

BE21-60

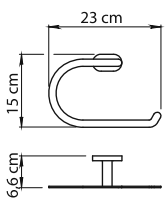

BE70

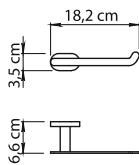

BE24

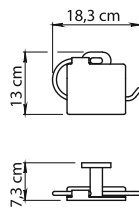

BE25

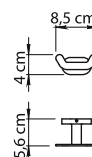

BE26

Romance.

Realizzata in acciaio inox e Cromall® con contenitori in vetro satinato

Made of stainless steel and Cromall® with frosted glass containers

Réalisée en acier inoxydable et Cromall® avec boîtiers en verre satiné

Hergestellt aus Edelstahl und Cromall® mit Behältern aus satiniertem Glas

Realizada en acero inoxidable y Cromall® con contenedores en cristal satinado

Изготовлено из нержавеющей стали и Cromall® с ёмкостями из матового стекла

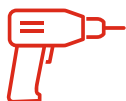

Con viti

With screws



Con colla

With glue

(Venduta a parte
Sold seperately)



GARANZIA
WARRANTY



44
Bronzo
Bronze

Romance.

SERIE DA MURO
Wall series



SERIE DA MURO . WALL LINES .

GEDY

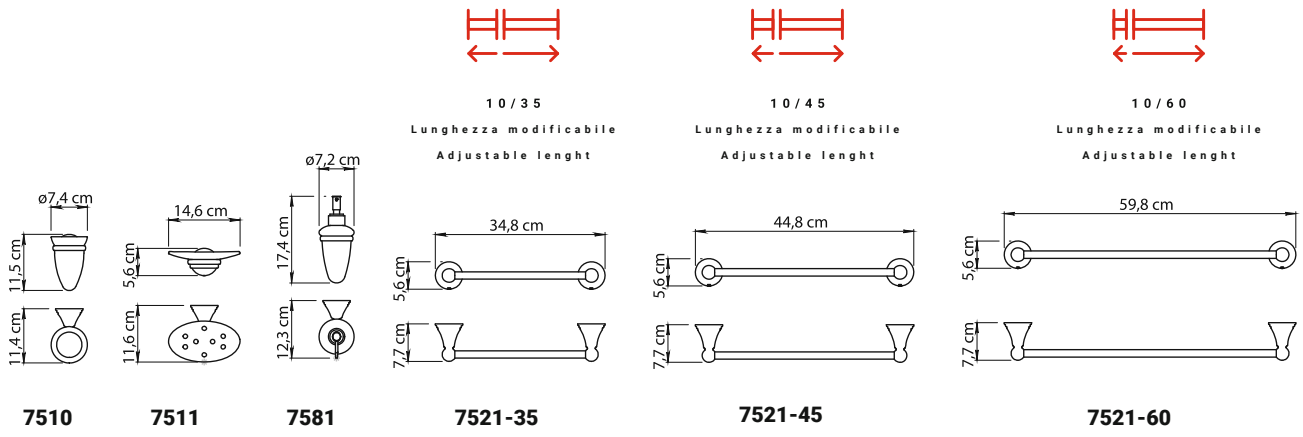

Romance



Vetro temperato Solo con viti
Tempered glass Only with screws

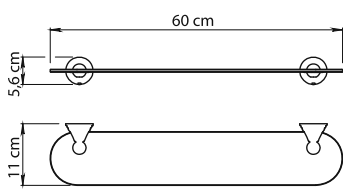

7519-60

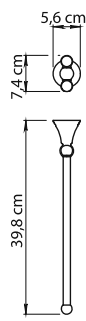

7523

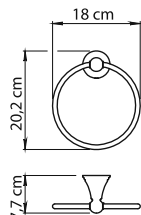

7570

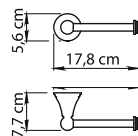

7524

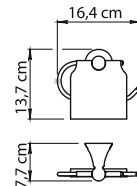

7525

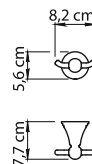

7526

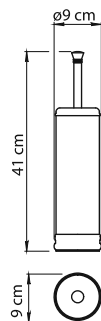

7533

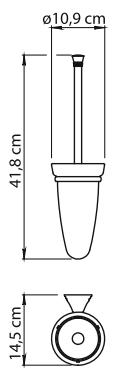

7533-03

GEDY

Colorado.

Realizzata in acciaio inox AISI 304 e Cromall® con contenitori in vetro satinato o acciaio inox

Made of AISI 304 stainless steel and Cromall® with frosted glass containers or stainless steel

Réalisée en acier inoxydable AISI 304 et Cromall® avec boîtiers en verre satiné ou acier inoxydable

Hergestellt aus Edelstahl AISI 304 und Cromall® mit Behältern aus satiniertem Glas oder Edelstahl

Realizada en acero inoxidable AISI 304 y Cromall® con contenedores en cristal satinado o acero inoxidable

Изготовлено из нержавеющей стали AISI 304 и Cromall® с ёмкостями из матового стекла или нержавеющей стали

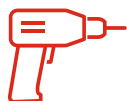

Con viti
With screws



Con colla
With glue

*(Venduta a parte
Sold seperately)*



GARANZIA
WARRANTY



13
Cromato
Chromed

Colorado.

SERIE DA MURO
Wall series



GEDY

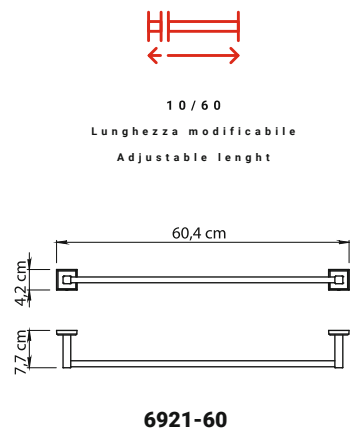
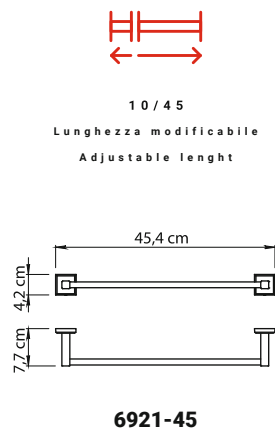
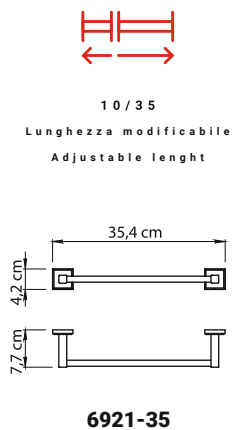
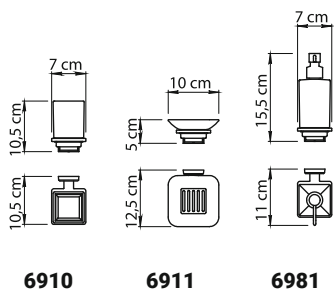



13
Lucido*
Polished

100%
AISI
304

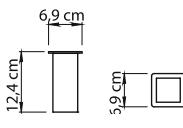

38101310*

100%
AISI
304

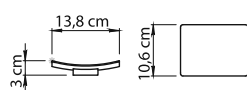

38111310*

AISI
304

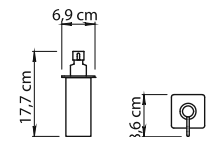

38811310*

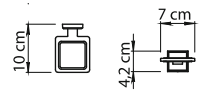

69101300



Vetro temperato
Tempered glass



Solo con viti
Only with screws

13
Lucido
Polished

2
YEARS
GARANZIA
WARRANTY

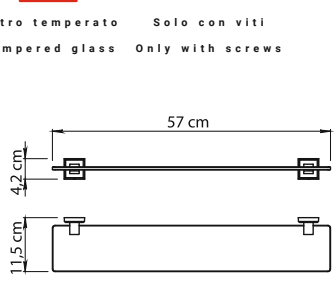

6919-60

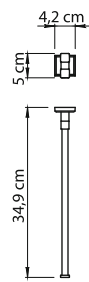

6923

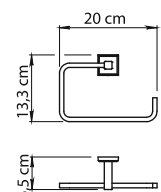

6970

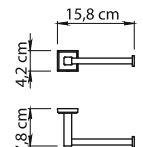

6924

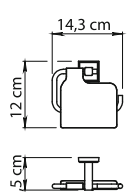

6925

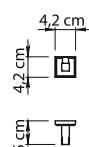

6926

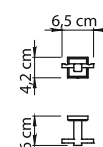

6928

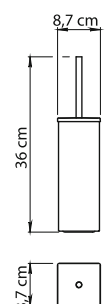

6933

GEDY

Nevis.



Realizzata in acciaio inox e Cromall® con contenitori in ceramica

Made of stainless steel and Cromall® with pottery containers

Réalisée en acier inoxydable et Cromall® avec boîtiers en céramique

Hergestellt aus Edelstahl und Cromall® mit Behältern aus Keramik

Realizada en acero inoxidable y Cromall® con contenedores en cerámica

Изготовлено из нержавеющей стали и Cromall® с ёмкостями из керамики

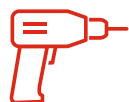

Con viti

With screws



GARANZIA

WARRANTY



13

Cromato
Chromed

Nevis.

SERIE DA MURO
Wall series



SERIE DA MURO . WALL LINES .

GEDY

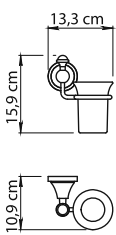

NV10

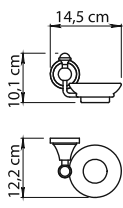

NV11

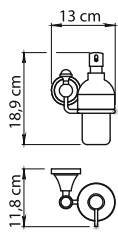

NV80

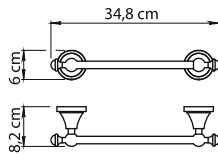

NV21-30

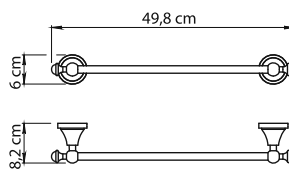

NV21-45

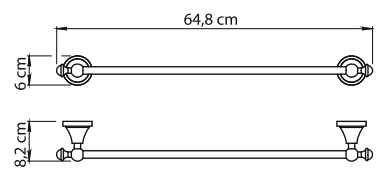

NV21-60

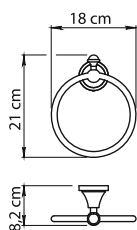

NV70

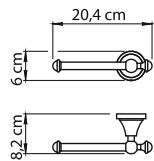

NV24

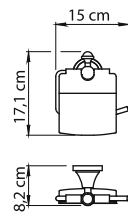

NV25

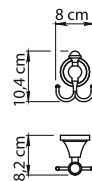

NV26

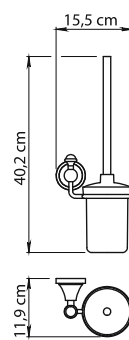

NV33-03

GEDY

Spluga.



Realizzata in acciaio inox, alluminio e Cromall® con contenitori in ceramica

Made of stainless steel, aluminium and Cromall® with pottery containers

Réalisée en acier inoxydable, aluminium et Cromall® avec boîtiers en céramique

Hergestellt aus Edelstahl, Aluminium und Cromall® mit Behältern aus Keramik

Realizada en acero inoxidable, aluminio y Cromall® con contenedores en cerámica

Изготовлено из нержавеющей стали, алюминия и Cromall® с ёмкостями из керамики

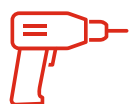

Con viti

With screws



GARANZIA

WARRANTY



13
Cromato
Chromed

Spluga.

SERIE DA MURO
Wall series

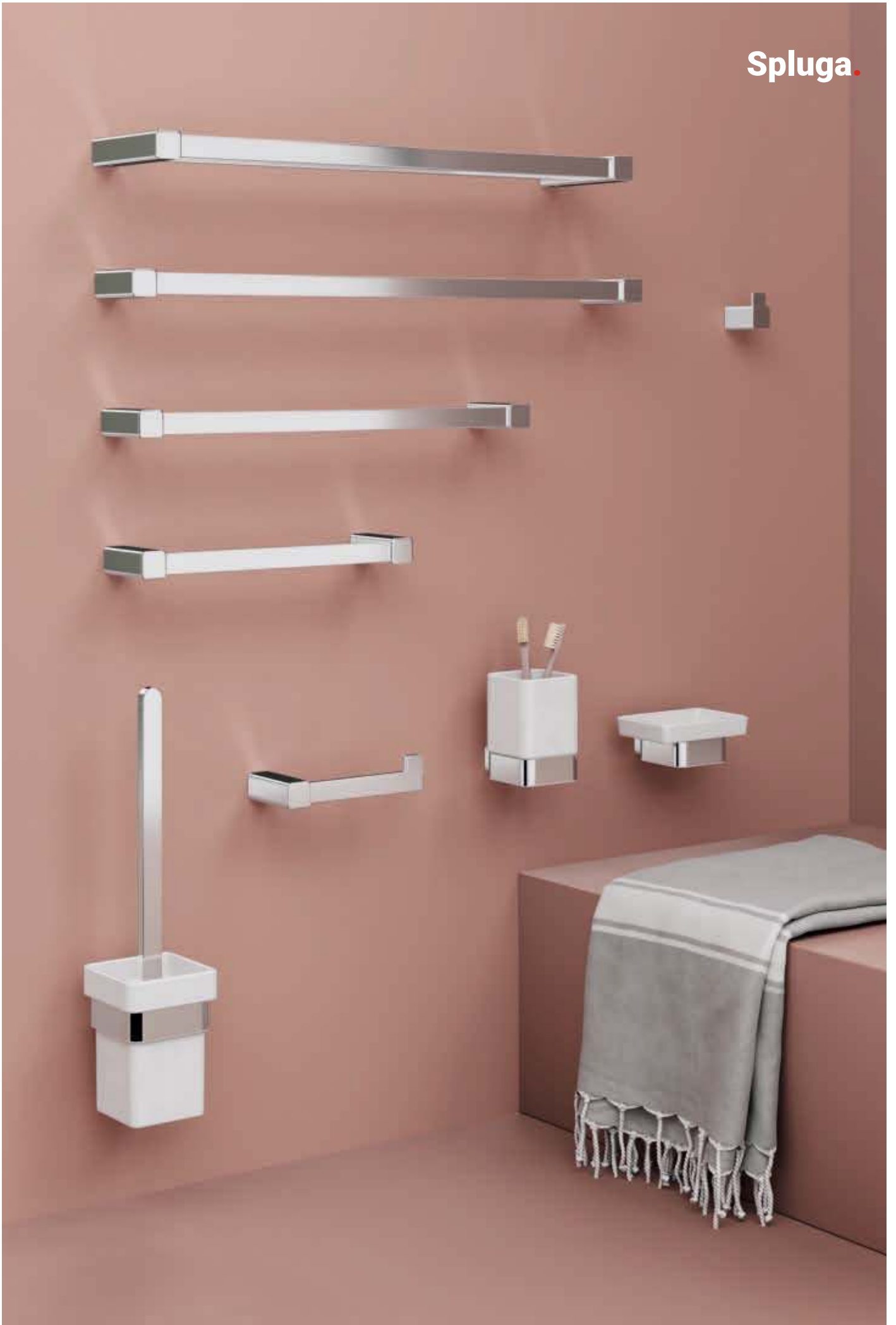

SERIE DA MURO. WALL LINES.

GEDY

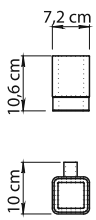

SG10

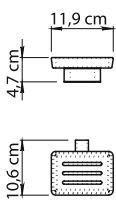

SG11

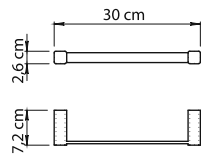

SG21-30

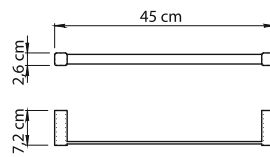

SG21-45

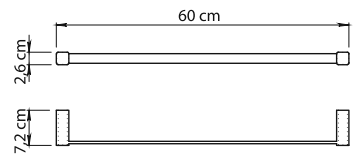

SG21-60

Spluga.

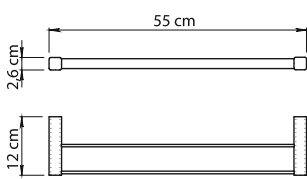

SG22

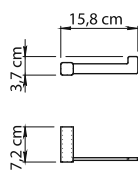

SG24

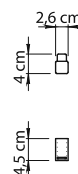

SG26

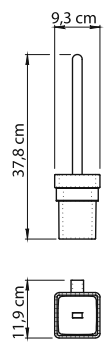

SG33-03

New Jersey.

Realizzata in acciaio inox, Cromall® e resine termoplastiche con contenitori in vetro satinato

Made of stainless steel, Cromall® and thermoplastic resins with frosted glass containers

Réalisée en acier inoxydable, Cromall® et résine thermoplastique avec boîtiers en verre satiné

Hergestellt aus Edelstahl, Cromall® und Kunststoff mit Behältern aus satiniertem Glas

Realizada en acero inox, Cromall® y resinas termoplásticas con contenedores en cristal satinado

Изготовлено из нержавеющей стали, Cromall® и термопластичных смол и матового стекла

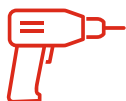

Con viti
With screws



Con colla
With glue

*(Venduta a parte
Sold seperately)*



GARANZIA
WARRANTY



13
Cromato
Chromed

New Jersey.

SERIE DA MURO
Wall series



SERIE DA MURO . WALL LINES .

GEDY

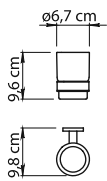
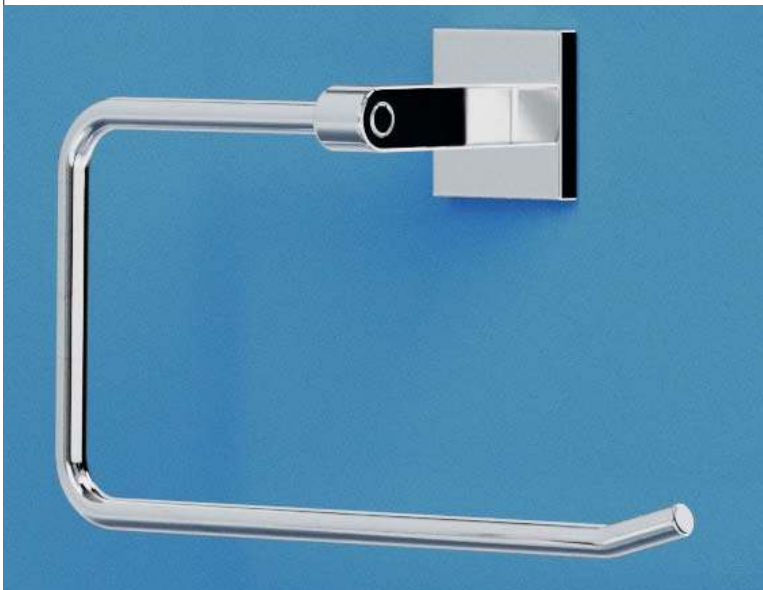

2810

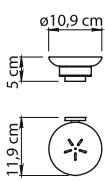

2811

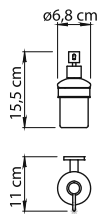

2881

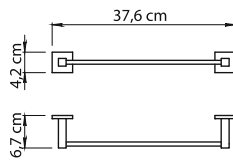

2821-35

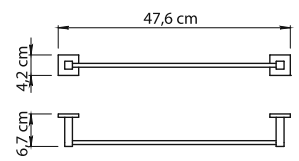

2821-45

New Jersey.

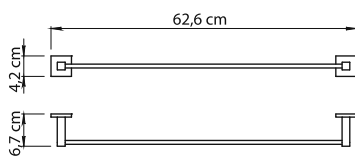

2821-60

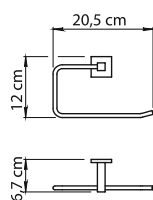

2870

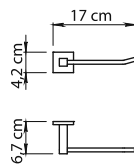

2824

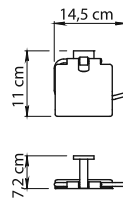

2825

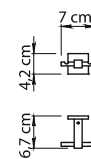

2826

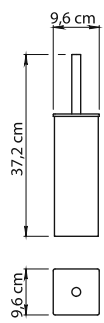

2833

13
Lucido
Polished

2
YEARS
GARANZIA
WARRANTY

GEDY

Edera Plus.

Realizzata in acciaio inox e Cromall® con contenitori in vetro satinato

Made of stainless steel and Cromall® with frosted glass containers

Réalisée en acier inoxydable et Cromall® avec boîtiers en verre satiné

Hergestellt aus Edelstahl und Cromall® mit Behältern aus satiniertem Glas

Realizada en acero inoxidable y Cromall® con contenedores en cristal satinado

Изготовлено из нержавеющей стали и Cromall® с ёмкостями из матового стекла

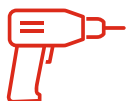

Con viti

With screws



Con colla

With glue

(Venduta a parte
Sold seperately)



GARANZIA
WARRANTY



13
Cromato
Chromed

Edera Plus.

SERIE DA MURO
Wall series



SERIE DA MURO. WALL LINES.

GEDY

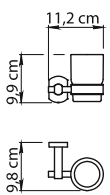

EP10

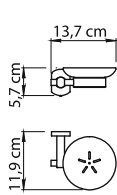

EP11

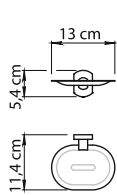

EP12

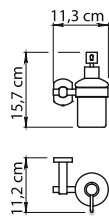

EP81



10 / 35
Lunghezza modificabile
Adjustable length

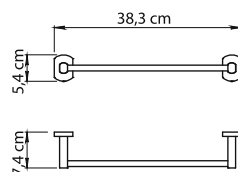

EP21-35



10 / 45
Lunghezza modificabile
Adjustable length

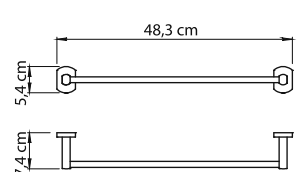

EP21-45



Edera Plus.

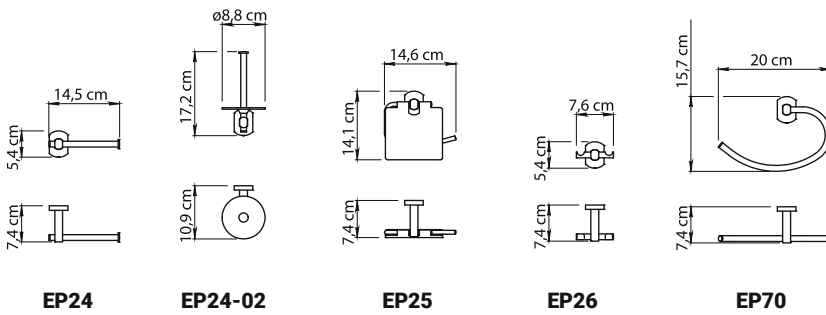

EP24

EP24-02

EP25

EP26

EP70



Solo con viti
Only with screws



10 / 60
Lunghezza modificabile
Adjustable length



Vetro temperato
Tempered glass



Solo con viti
Only with screws

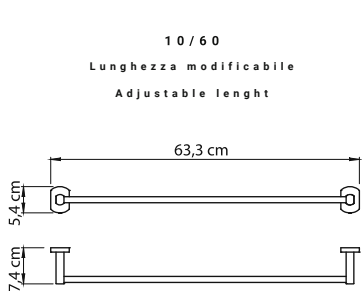

EP21-60

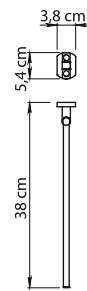

EP23

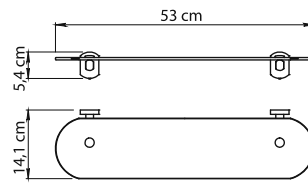

EP19-55



ED34-03

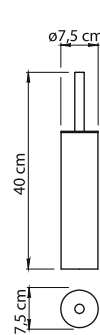

ED34

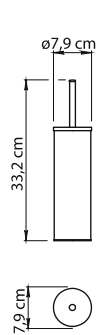

EP33

GEDY

Wizard.

Realizzata in ottone e Cromall® con contenitori in metacrilato trasparente

Made of brass and Cromall® with transparent methacrylate containers

Réalisée en laiton et Cromall® avec boîtiers en méthacrylate transparent

Hergestellt aus Messing und Cromall® mit durchsichtigen Behältern aus Methacrylat

Realizada en latón y Cromall® con contenedores en metacrilato transparente

Изготовлено из латуни и Cromall® с контейнерами из прозрачного метакрилата



Con biadesivo
With double sided
tape



GARANZIA
WARRANTY



13
Cromato
Chromed



10 / 35

Lunghezza modificabile
Adjustable length



10 / 50

Lunghezza modificabile
Adjustable length

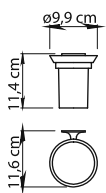

WZ10

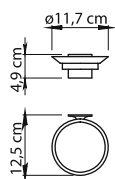

WZ11

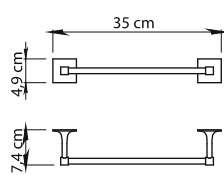

WZ21-30

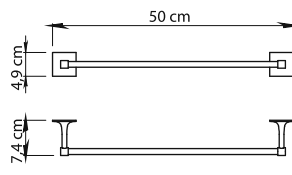

WZ21-45

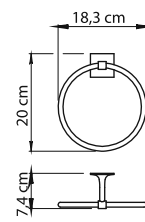

WZ70

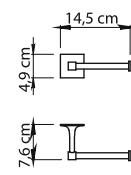

WZ24

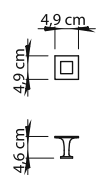

WZ27

GEDY

Tonga.



Realizzata in acciaio inox e Cromall® con contenitori in vetro satinato

Made of stainless steel and Cromall® with frosted glass containers

Réalisée en acier inoxydable et Cromall® avec boîtiers en verre satiné

Hergestellt aus Edelstahl und Cromall® mit Behältern aus satiniertem Glas

Realizada en acero inoxidable y Cromall® con contenedores en cristal satinado

Изготовлено из нержавеющей стали и Cromall® с ёмкостями из матового стекла

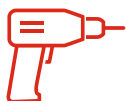

Con viti

With screws



Con biadesivo

With double sided
tape



GARANZIA

WARRANTY



02

Bianco matt
Matt white



13

Cromato
Chromed



14

Nero matt
Matt black

Tonga.

SERIE DA MURO
Wall series



SERIE DA MURO WALL LINES

GEDY

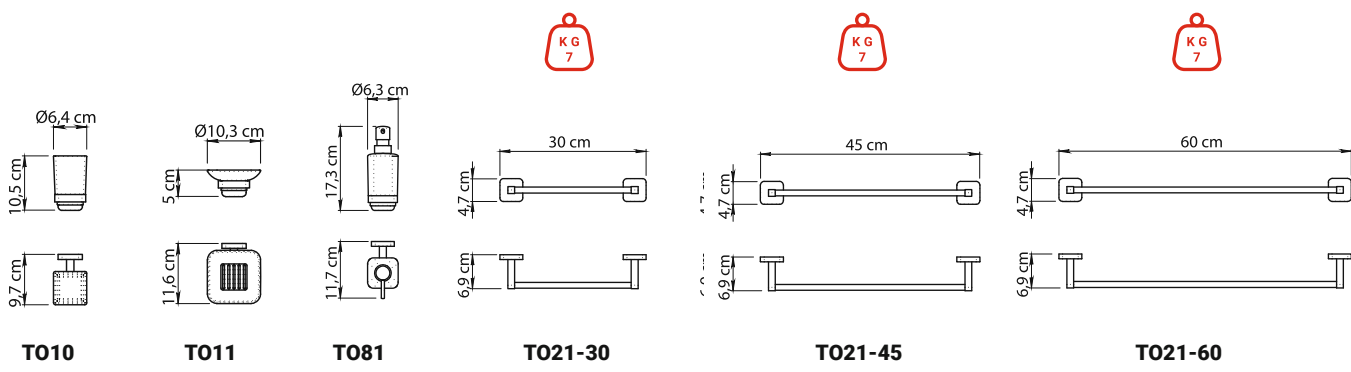

Tonga.



Solo con viti
Only with screws

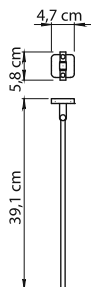

T023

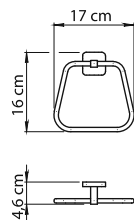

T070

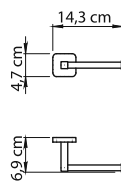

T024

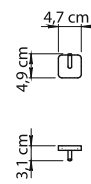

T027
2 pz - 2 pcs

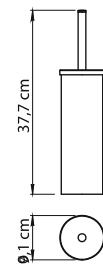

T033



02
Bianco matt
Matt white



13
Lucido
Polished



14
Nero matt
Matt black

Fuji.

Realizzata in acciaio inox AISI 304 e Cromall® con contenitori in vetro satinato

Made of AISI 304 stainless steel and Cromall® with frosted glass containers

Réalisée en acier inoxydable AISI 304 et Cromall® avec boîtiers en verre satiné

Hergestellt aus Edelstahl AISI 304 und Cromall® mit Behältern aus satiniertem

Realizada en acero inox AISI 304 y Cromall® con contenedores en cristal satinado

Изготовлено из нержавеющей стали AISI 304 и Cromall® с ёмкостями из матового стекла

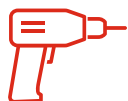

Con viti

With screws



Con biadesivo

With double sided
tape



GARANZIA
WARRANTY



13
Cromato
Chromed



38
Spazzolato
Brushed

Fuji.

SERIE DA MURO
Wall series

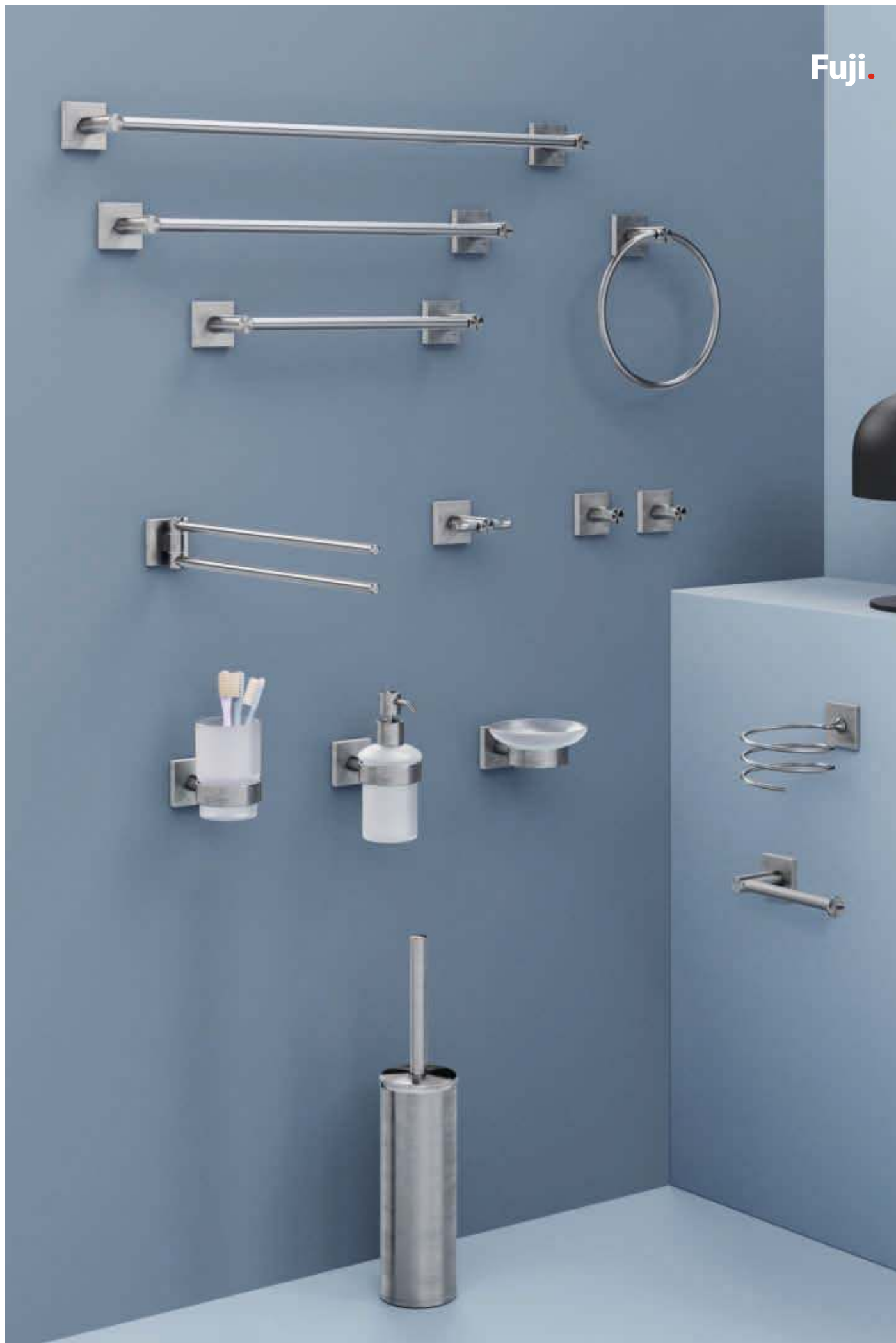

SERIE DA MURO . WALL LINES .

GEDY

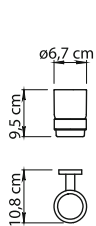
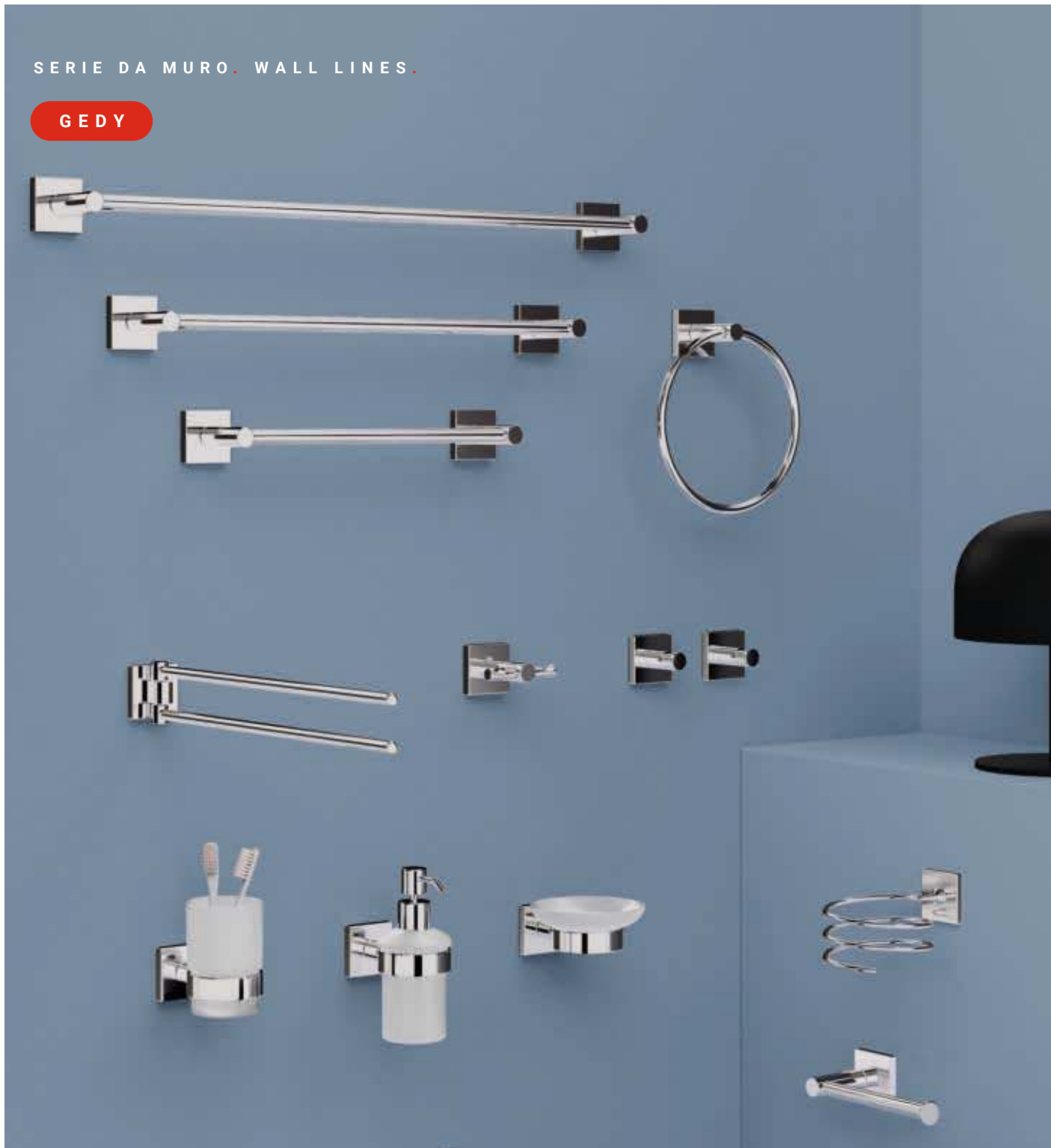

FJ10

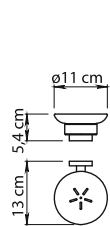

FJ11

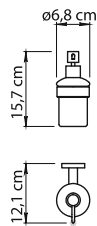

FJ81

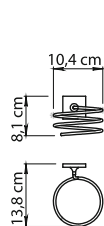

FJ55



10 / 30

Lunghezza modificabile
Adjustable length

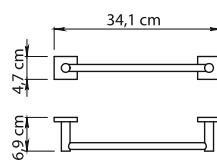

FJ21-30



10 / 45

Lunghezza modificabile
Adjustable length

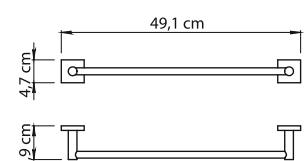

FJ21-45



Fuji.



10 / 60
Lunghezza modificabile
Adjustable length

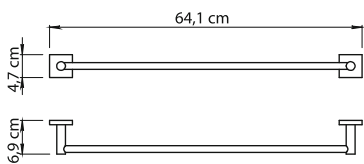

FJ21-60

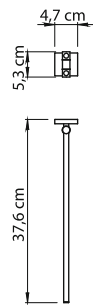

FJ23

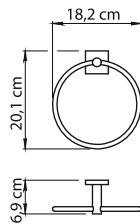

FJ70

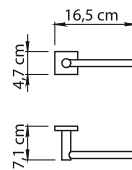

FJ24

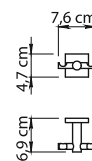

FJ26

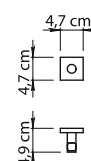

FJ27
2 pz - 2 pcs

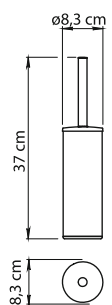

FJ33

Stelvio.

Realizzata in acciaio inox e Cromall® con contenitori in vetro satinato

Made of stainless steel and Cromall® with frosted glass containers

Réalisée en acier inoxydable et Cromall® avec boîtiers en verre satiné

Hergestellt aus Edelstahl und Cromall® mit Behältern aus satiniertem Glas

Realizada en acero inoxidable y Cromall® con contenedores en cristal satinado

Изготовлено из нержавеющей стали и Cromall® с ёмкостями из матового стекла

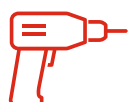

Con viti

With screws



Con colla

With glue

(Venduta a parte
Sold seperately)



GARANZIA
WARRANTY



13
Cromato
Chromed



14
Nero matt
Matt black

Stelvio.

SERIE DA MURO
Wall series

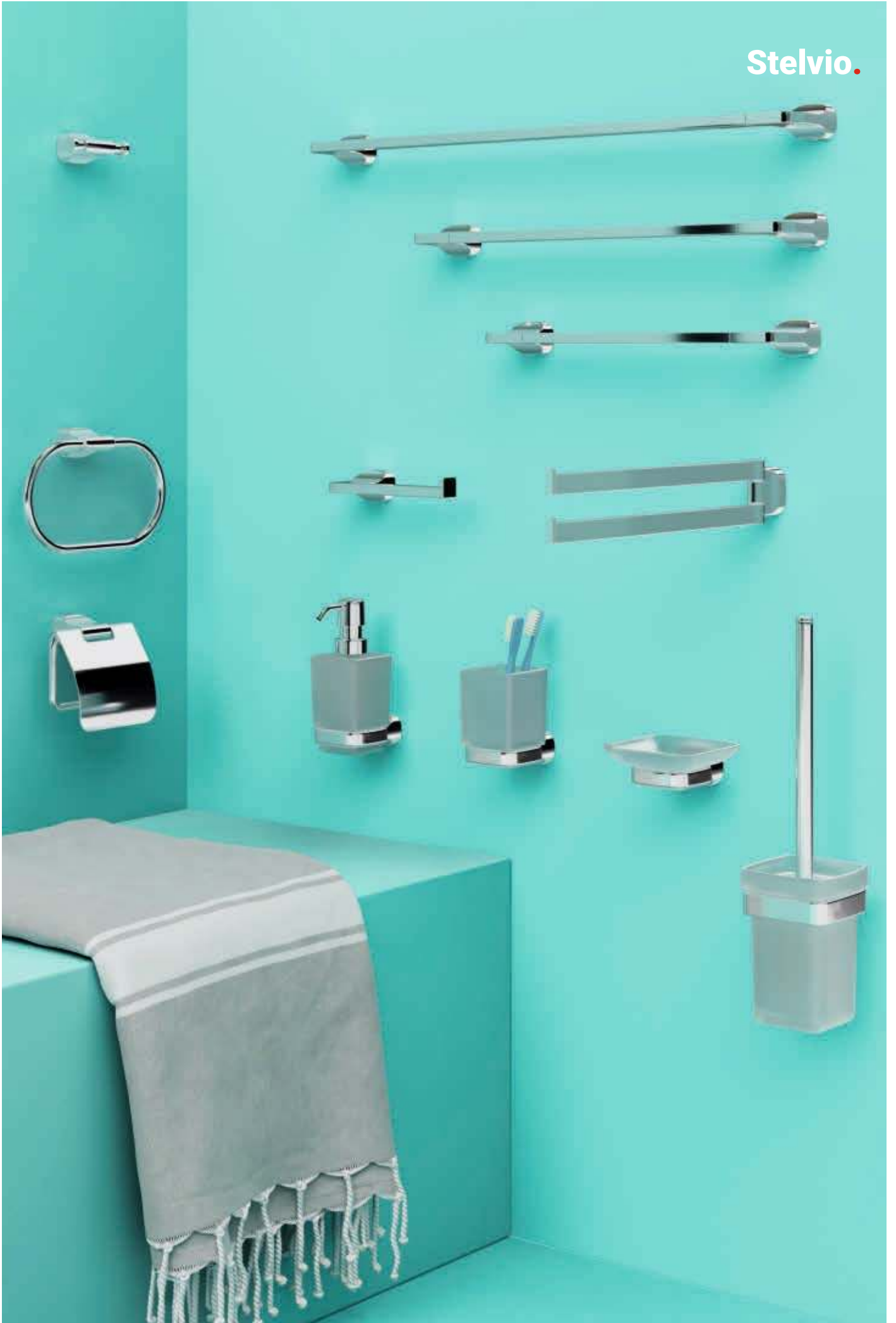

SERIE DA MURO. WALL LINES.

GEDY

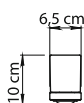
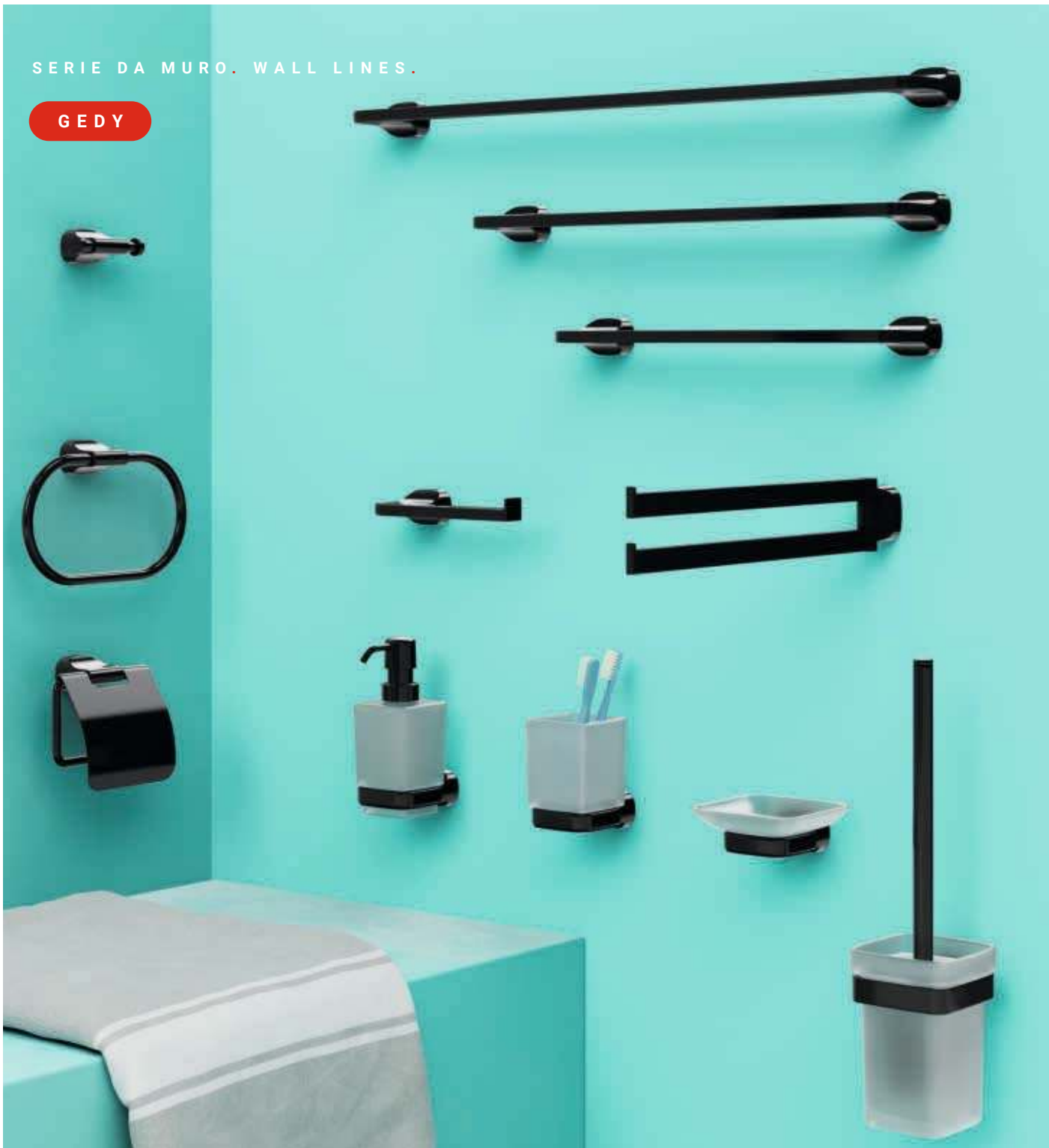

ST10

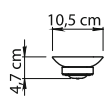

ST11

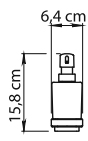

ST80

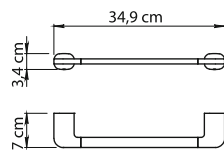

ST21-35

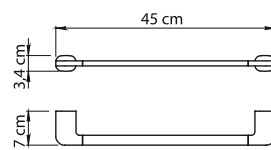

ST21-45



Stelvio.



Solo con viti
Only with screws

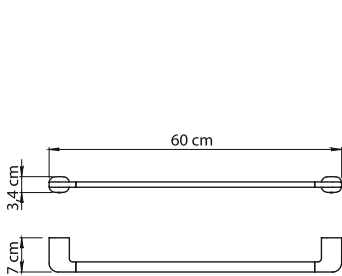

ST21-60

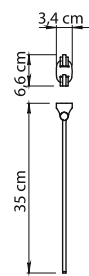

ST23

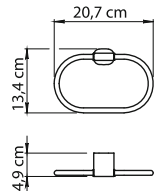

ST70

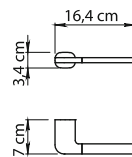

ST24

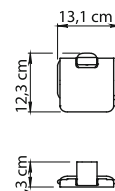

ST25

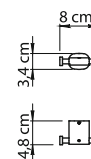

ST26

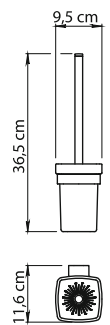

ST33-03

GEDY

Tonale.

NEW

Realizzata in acciaio inox e Cromall® con contenitori in vetro satinato

Made of stainless steel and Cromall® with frosted glass containers

Réalisée en acier inoxydable et Cromall® avec boîtiers en verre satiné

Hergestellt aus Edelstahl und Cromall® mit Behältern aus satiniertem Glas

Realizada en acero inoxidable y Cromall® con contenedores en cristal satinado

Изготовлено из нержавеющей стали и Cromall® с ёмкостями из матового стекла



Con viti

With screws



GARANZIA

WARRANTY



13
Cromato
Chromed



88
Oro matt
Matt gold

Tonale.

SERIE DA MURO
Wall series



SERIE DA MURO. WALL LINES.

GEDY

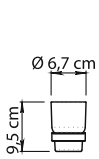

TN10

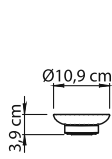

TN11

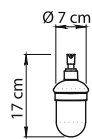

TN80

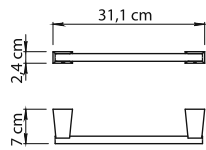

TN21-30

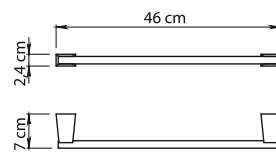

TN21-45

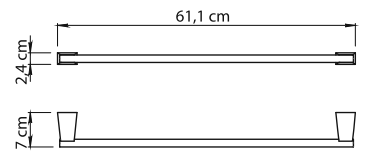

TN21-60

Tonale.

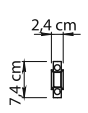

TN23

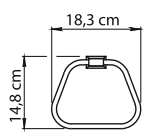

TN70

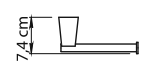
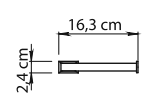

TN24

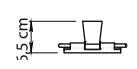
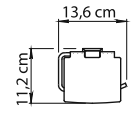

TN25

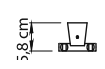
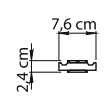

TN26

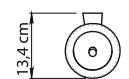
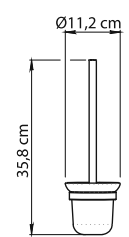

TN33-03

GEDY

Felce.

Realizzata in acciaio inox e Cromall® con contenitori in vetro satinato

Made of stainless steel and Cromall® with frosted glass containers

Réalisée en acier inoxydable et Cromall® avec boîtiers en verre satiné

Hergestellt aus Edelstahl und Cromall® mit Behältern aus satiniertem Glas

Realizada en acero inoxidable y Cromall® con contenedores en cristal satinado

Изготовлено из нержавеющей стали и Cromall® с ёмкостями из матового стекла

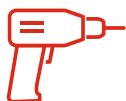

Con viti

With screws



Con colla

With glue



GARANZIA
WARRANTY

(Venduta a parte
Sold seperately)



13
Cromato
Chromed

Felce.

SERIE DA MURO
Wall series



GEDY



10 / 30

Lunghezza modificabile
Adjustable length



10 / 50

Lunghezza modificabile
Adjustable length



10 / 60

Lunghezza modificabile
Adjustable length

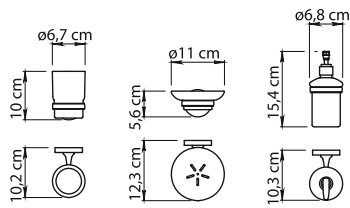

FE10

FE11

FE81

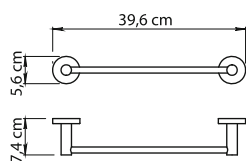

FE21-35

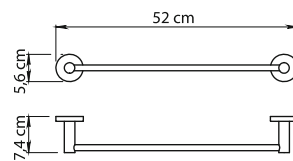

FE21-45

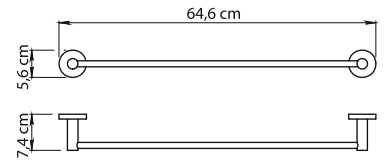

FE21-60



Felce.



Solo con viti
Only with screws

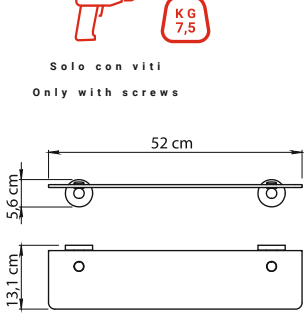

FE19-55

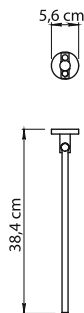

FE23

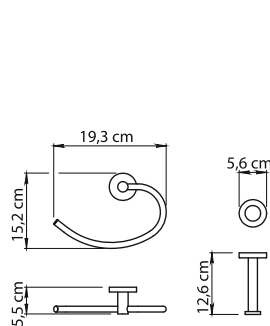

FE70

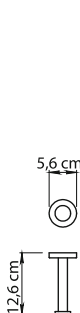

FE24

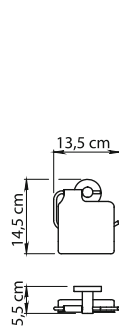

FE25

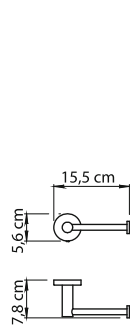

FE29

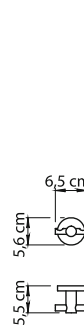

FE26

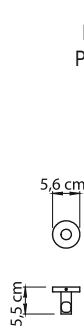

FE27

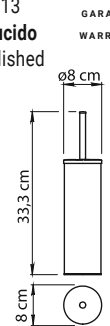

FE33

13
Lucido
Polished

2
YEARS

GARANZIA
WARRANTY

GEDY

Olimpo.

Realizzata in acciaio inox e Cromall® con contenitori in vetro satinato

Made of stainless steel and Cromall® with frosted glass containers

Réalisée en acier inoxydable et Cromall® avec boîtiers en verre satiné

Hergestellt aus Edelstahl und Cromall® mit Behältern aus satiniertem Glas

Realizada en acero inoxidable y Cromall® con contenedores en cristal satinado

Изготовлено из нержавеющей стали и Cromall® с ёмкостями из матового стекла

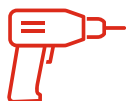

Con viti
With screws



Con colla
With glue

**(Venduta a parte
Sold seperately)**



**GARANZIA
WARRANTY**



13
Cromato
Chromed

Olimpo.

SERIE DA MURO
Wall series



GEDY

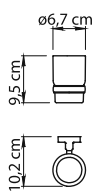
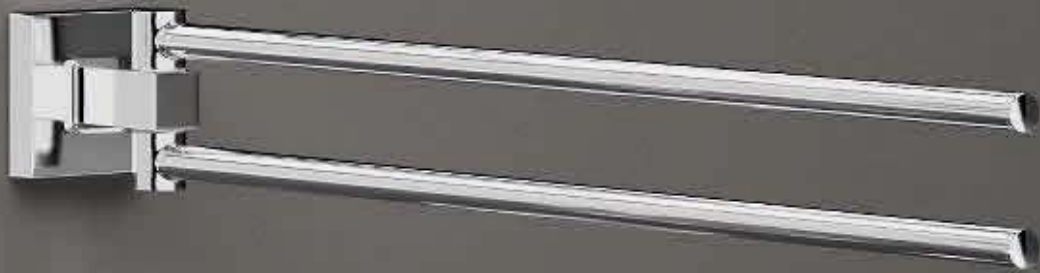

OI10

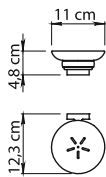

OI11

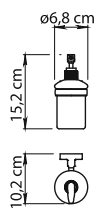

OI81



10/30
Lunghezza modificabile
Adjustable length

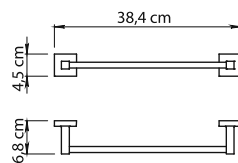

OI21-35



10/45
Lunghezza modificabile
Adjustable length

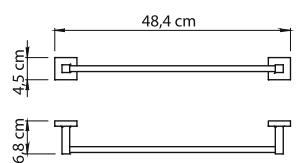

OI21-45

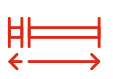

10 / 60
Lunghezza modificabile
Adjustable length



Solo con viti
Only with screws

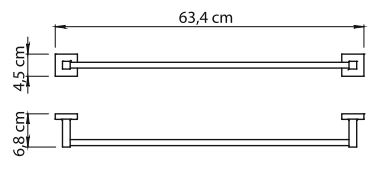

OI21-60

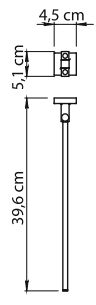

OI23

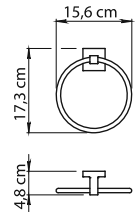

OI70

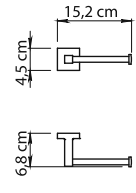

OI24

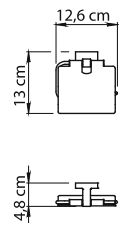

OI25

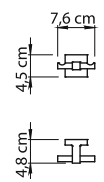

OI26

Teide.

Realizzata in acciaio inox e Cromall® con contenitori in vetro satinato

Made of stainless steel and Cromall® with frosted glass containers

Réalisée en acier inoxydable et Cromall® avec boîtiers en verre satiné

Hergestellt aus Edelstahl und Cromall® mit Behältern aus satiniertem Glas

Realizada en acero inoxidable y Cromall® con contenedores en cristal satinado

Изготовлено из нержавеющей стали и Cromall® с ёмкостями из матового стекла

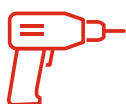

Con viti

With screws



Con biadesivo

With double sided

tape



GARANZIA

WARRANTY



13

Cromato
Chromed



14

Nero matt
Matt black

Teide

SERIE DA MURO
Wall series



SERIE DA MURO . WALL LINES .

GEDY

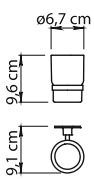
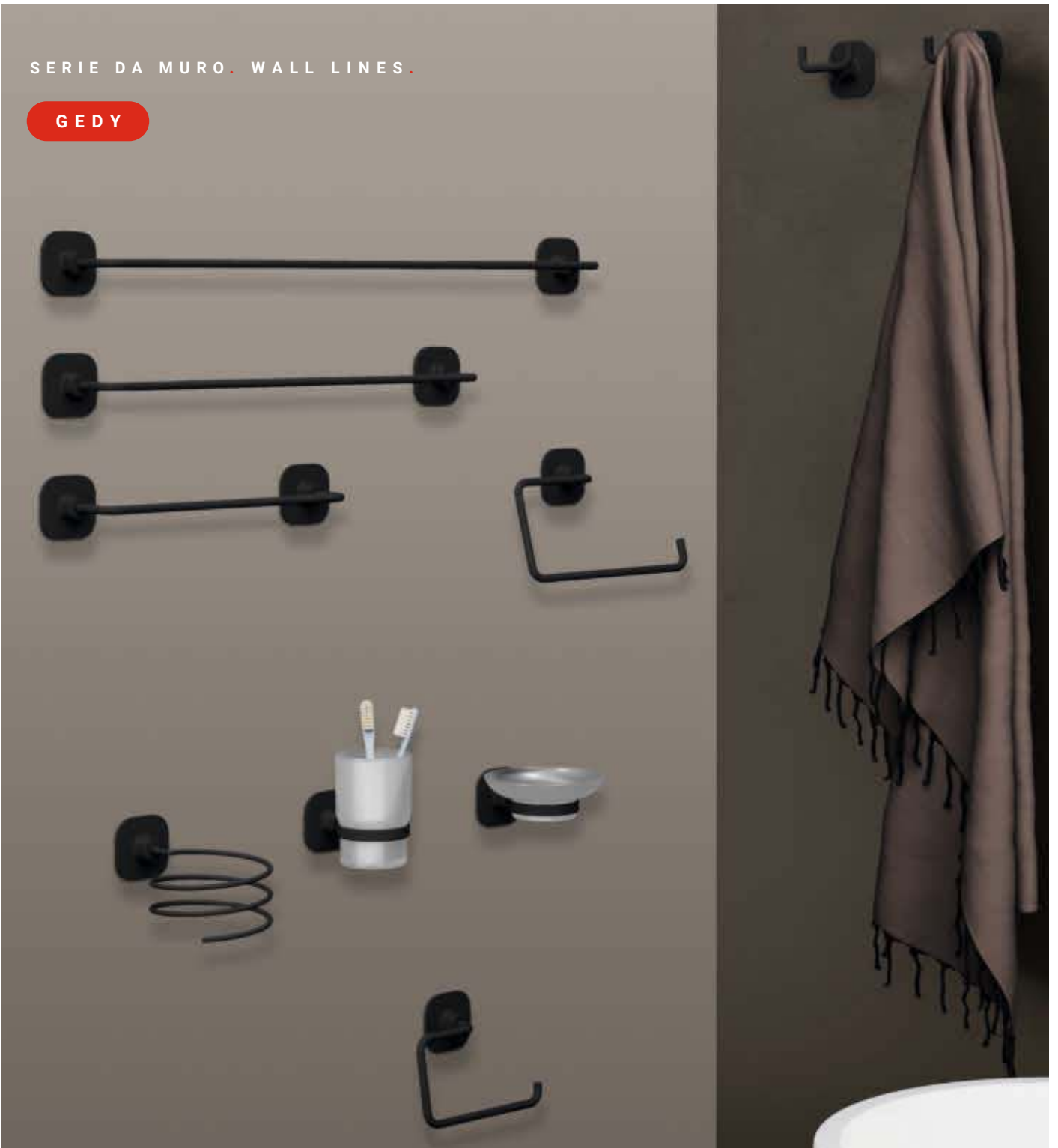

TE10

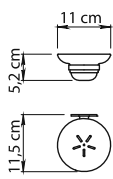

TE11

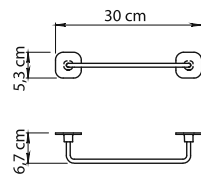

TE21-30

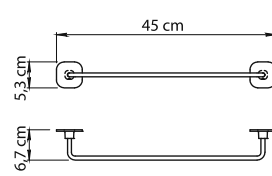

TE21-45

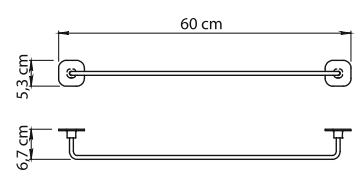

TE21-60

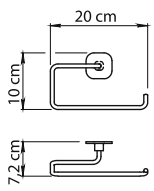

TE70

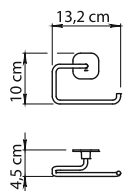

TE24

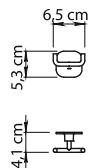

TE26

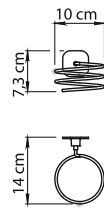

TE55

GEDY

Cervino.

Realizzata in acciaio inox e Cromall® con contenitori in vetro satinato

Made of stainless steel and Cromall® with frosted glass containers

Réalisée en acier inoxydable et Cromall® avec boîtiers en verre satiné

Hergestellt aus Edelstahl und Cromall® mit Behältern aus satiniertem Glas

Realizada en acero inoxidable y Cromall® con contenedores en cristal satinado

Изготовлено из нержавеющей стали и Cromall® с ёмкостями из матового стекла

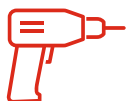

Con viti

With screws



Con colla

With glue

(Venduta a parte
Sold seperately)



GARANZIA
WARRANTY



13
Cromato
Chromed

Cervino.

SERIE DA MURO
Wall series



SERIE DA MURO. WALL LINES.

GEDY

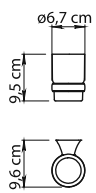

CE10

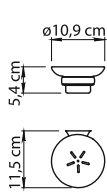

CE11

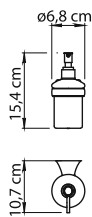

CE80



10 / 30
Lunghezza modificabile
Adjustable length

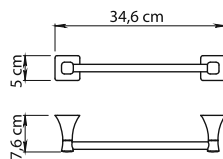

CE21-35



10 / 40
Lunghezza modificabile
Adjustable length

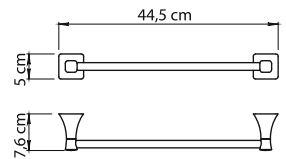

CE21-45



10 / 55
Lunghezza modificabile
Adjustable length

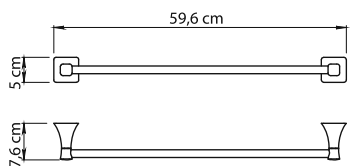

CE21-60

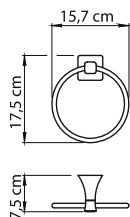

CE70

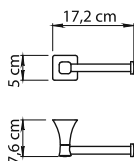

CE24

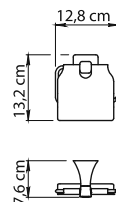

CE25

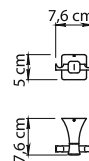

CE26

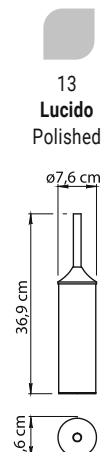

13
Lucido
Polished

CE33

Everest.

Realizzata in acciaio inox e Cromall® con contenitori in vetro satinato

Made of stainless steel and Cromall® with frosted glass containers

Réalisée en acier inoxydable et Cromall® avec boîtiers en verre satiné

Hergestellt aus Edelstahl und Cromall® mit Behältern aus satiniertem Glas

Realizada en acero inoxidable y Cromall® con contenedores en cristal satinado

Изготовлено из нержавеющей стали и Cromall® с ёмкостями из матового стекла

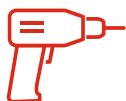

Con viti

With screws



Con colla

With glue

(Venduta a parte
Sold seperately)



GARANZIA
WARRANTY



13
Cromato
Chromed

Everest.

SERIE DA MURO
Wall series



GEDY

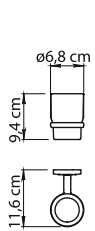

EV10

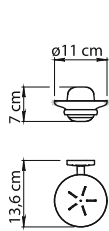

EV11

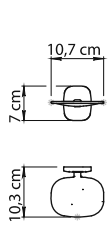

EV12

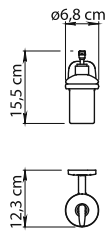

EV80



10 / 35
Lunghezza modificabile
Adjustable length

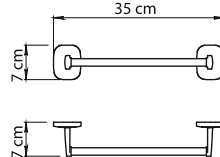

EV21-35



10 / 45
Lunghezza modificabile
Adjustable length

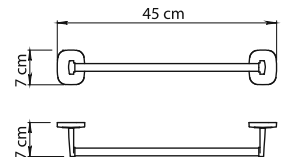

EV21-45

Everest



10/60
Lunghezza modificabile
Adjustable length

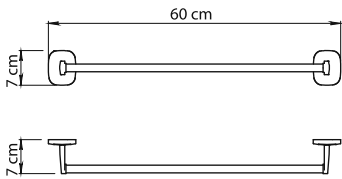

Solo con viti
Only with screws

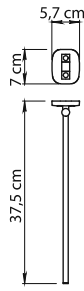

EV21-60

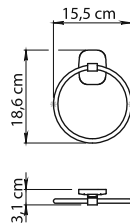

EV23



EV70

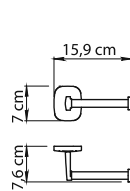

EV24

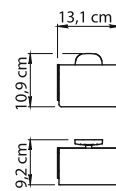

EV25

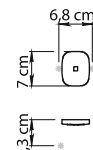

EV26

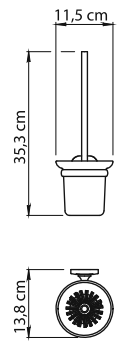

EV33-03

K2.

Realizzata in alluminio anodizzato e Cromall® con contenitori in vetro satinato

Made of anodized aluminium and Cromall® with frosted glass containers

Réalisée en aluminium anodisé et Cromall® avec boîtiers en verre satiné

Hergestellt aus Eloxiertes Aluminium und Cromall® mit Behältern aus satiniertem Glas

Realizada en aluminio anodizado y Cromall® con contenedores en cristal satinado

Изготовлено из анодированный алюминий и Cromall® с ёмкостями из матового стекла

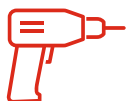

Con viti

With screws



Con colla

With glue



GARANZIA
WARRANTY

(Venduta a parte
Sold seperately)



13
Cromato
Chromed

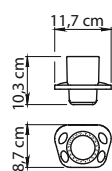

KD10



10 / 30
Lunghezza modificabile
Adjustable length



10 / 45
Lunghezza modificabile
Adjustable length



10 / 60
Lunghezza modificabile
Adjustable length

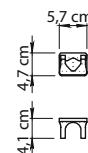

KD26

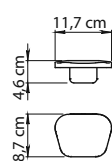

KD12

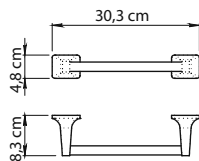

KD21-30

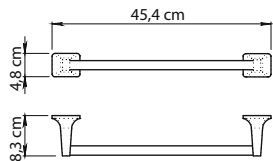

KD21-45

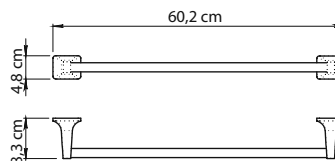

KD21-60

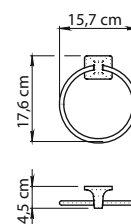

KD70

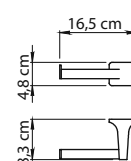

KD24

Ventus.

Realizzata in acciaio inox e ABS con contenitori in metacrilato trasparente

Made of stainless steel and ABS with transparent methacrylate containers

Réalisée en acier inoxydable et ABS avec boîtiers en méthacrylate transparent

Hergestellt aus Edelstahl und ABS mit durchsichtigen Behältern aus Methacrylat

Realizada en acero inox y ABS con contenedores en metacrilato transparente

Изготовлено из нержавеющей стали и ABS с контейнерами из прозрачного метакрилата



Con ventosa

With suction cup

Solo su superfici lisce
(specchi, piastrelle)
For flat surfaces
(mirrors, tiles) only



GARANZIA
WARRANTY



13
Cromato
Chromed

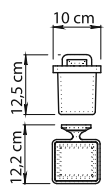

VN10



10 / 35
Lunghezza modificabile
Adjustable length



10 / 50
Lunghezza modificabile
Adjustable length



10 / 65
Lunghezza modificabile
Adjustable length



VN26



VN24

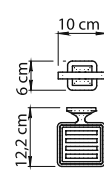

VN11

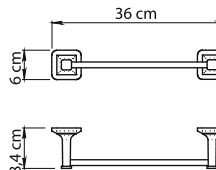

VN21-30

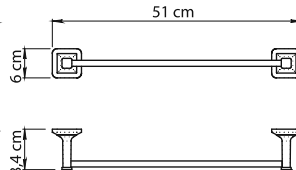

VN21-45

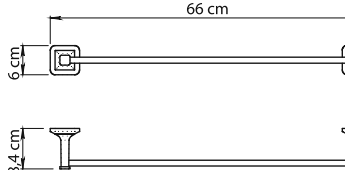

VN21-60

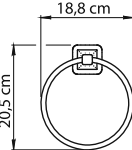

VN70

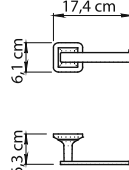

GEDY

Genziana.

Realizzata in acciaio inox e Cromall® con contenitori in vetro satinato

Made of stainless steel and Cromall® with frosted glass containers

Réalisée en acier inoxydable et Cromall® avec boîtiers en verre satiné

Hergestellt aus Edelstahl und Cromall® mit Behältern aus satiniertem Glas

Realizada en acero inoxidable y Cromall® con contenedores en cristal satinado

Изготовлено из нержавеющей стали и Cromall® с ёмкостями из матового стекла

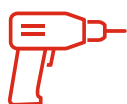

Con viti
With screws



GARANZIA
WARRANTY



13
Cromato
Chromed



02
Bianco
White

Genziana

SERIE DA MURO
Wall series



SERIE DA MURO . WALL LINES .

GEDY



13
solo - only

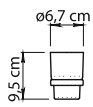

GE10

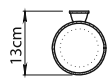
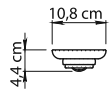

GE11

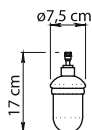

GE80

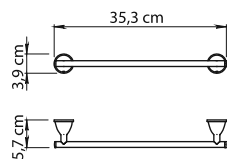

GE21-35

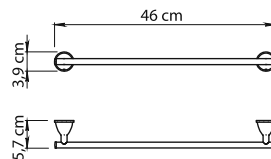

GE21-45

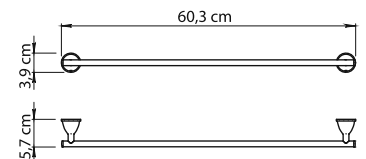

GE21-60



Genziana.



  
Vetro temperato
Tempered glass
13
solo - only

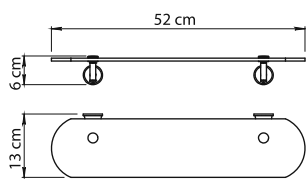

GE19-55

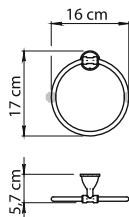

GE70

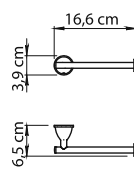

GE24

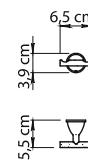

GE26



GE33

 
02 **Bianco** 13 **Lucido**
White Polished

2
YEARS
GARANZIA
WARRANTY

GEDY

Set Ficus.



Realizzato in metallo e Cromall® con contenitori in vetro satinato

Made of metal and Cromall® with frosted glass containers

Réalisée en métal et Cromall® avec boîtiers en verre satiné

Hergestellt aus Metall und Cromall® mit Behältern aus satiniertem Glas

Realizada en metal y Cromall® con contenedores en cristal satinado

Изготовлено из металла и Cromall® с ёмкостями из матового стекла

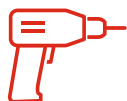

Con viti

With screws



GARANZIA
WARRANTY



13

Cromato-lucido
Chromed-polished

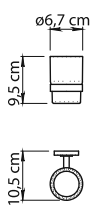
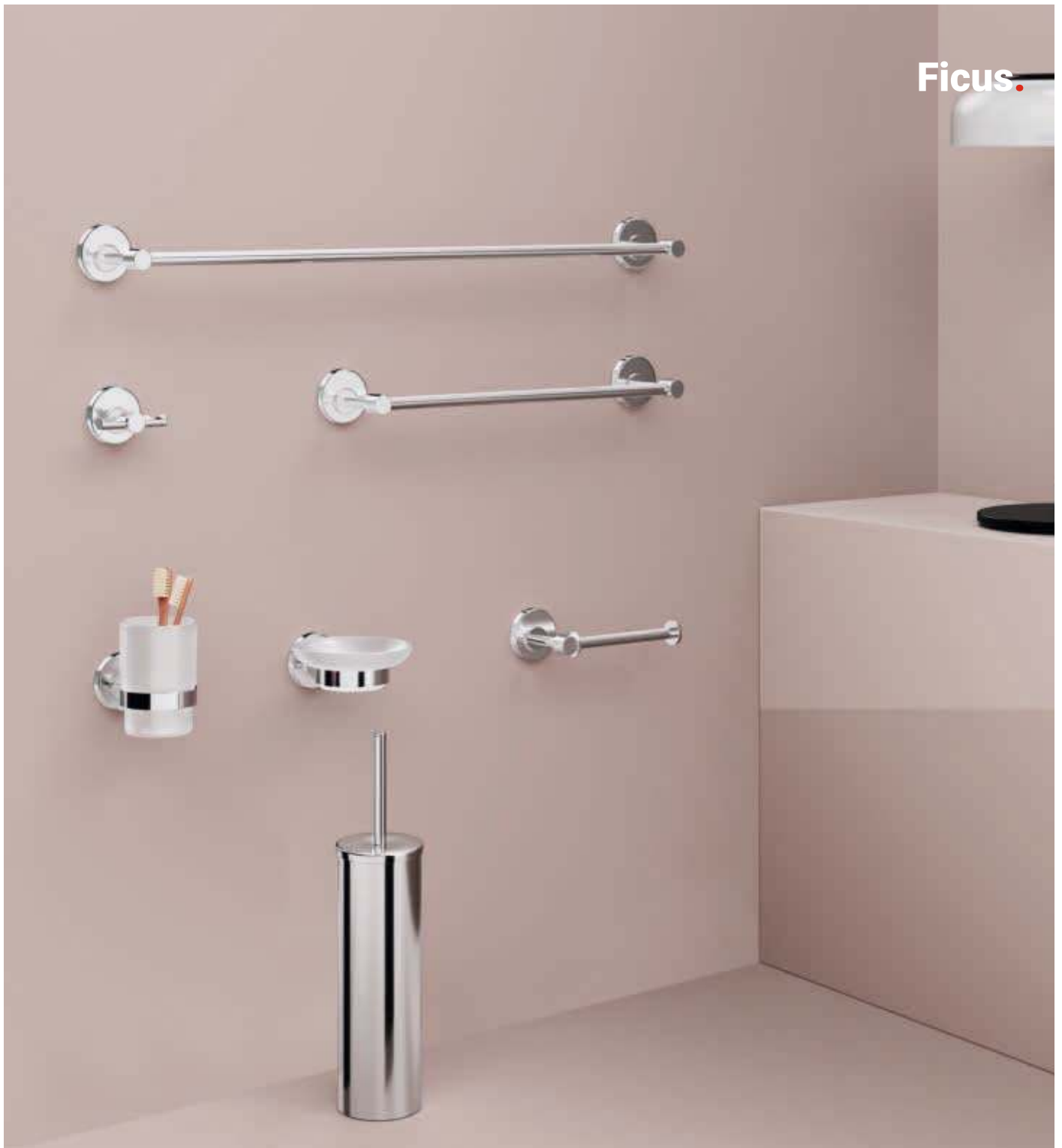

FI10

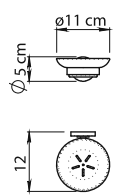

FI11

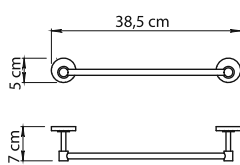

FI21-35

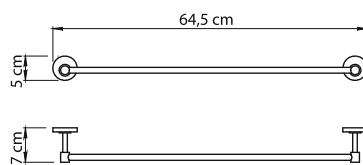

FI21-60

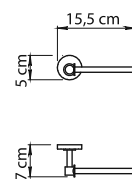

FI24



FI26

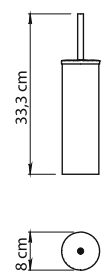

FI33

GEDY

Hot.

Realizzata in metallo e resine termoplastiche

Made of metal and thermoplastic resins

Réalisée en métal et en résine thermoplastique

Hergestellt aus Metall und Kunststoff

Realizada en metal y resinas termoplásticas

Изготовлено из металла и термопластичных смол



Con ventosa

With suction cup

Solo su superfici lisce
(specchi, piastrelle)
For flat surfaces
(mirrors, tiles) only



GARANZIA
WARRANTY



13
Cromato
Chromed



14
Nero
Black

Hot.

SERIE DA MURO
Wall series



GEDY

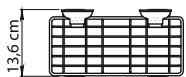
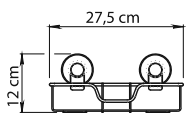

H020

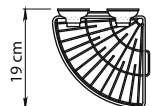
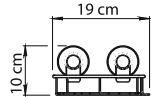

H080

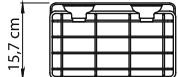
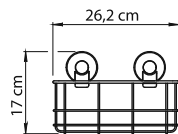

H018

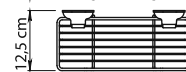
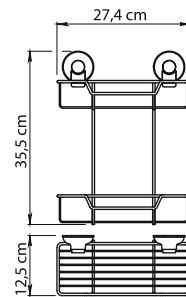

H019



13
solo - only

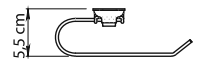
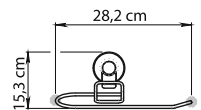

H021-30

Hot.



13
solo - only

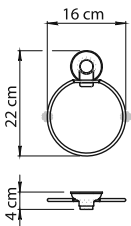

H070



14

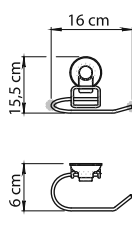

H024



6,3 cm

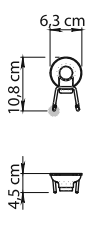

H026



13
solo - only

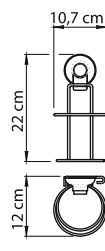

H052

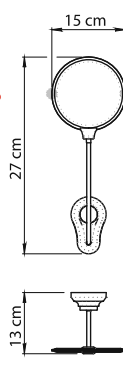

H008



13
solo - only

Specchio
orientabile
Adjustable
mirrore

GEDY

Darios.

Realizzata in resine termoindurenti

Made of thermosetting resins

Réalisée en résine thermodurcissable

Hergestellt aus Duroplast

Realizada en resinas termoestables

Изготовлено из термореактивных смол

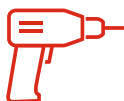

Con viti
With screws



GARANZIA
WARRANTY

100% MADE
in Italy



02
Bianco
White

Realizzate in resine termoplastiche - Made of thermosetting resins *

design Gianpietro Tonetti**

Darios.

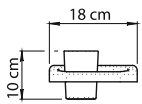

7210

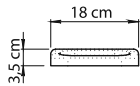

7211

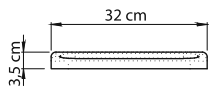

7218

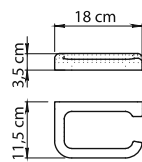

7224

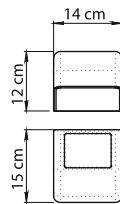

7225*

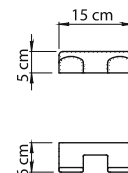

7226



GARANZIA
WARRANTY

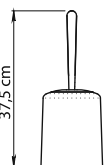

8034*
**

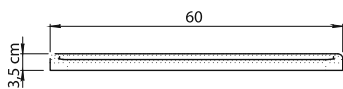

7221-60

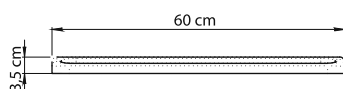

7219-60

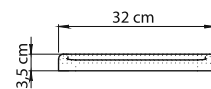

7221-30

SERIE DA MURO . WALL LINES .

GEDY

2900.

design Makio Hasuike

Realizzata in resine termoplastiche

Made of thermoplastic resins

Réalisée en résine thermoplastique

Hergestellt aus Kunststoff

Realizada en resinas termoplásticas

Изготовлено из термопластичных смол

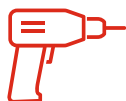

Con viti

With screws

100% MADE
in **Italy**



02
Bianco
White

2900.

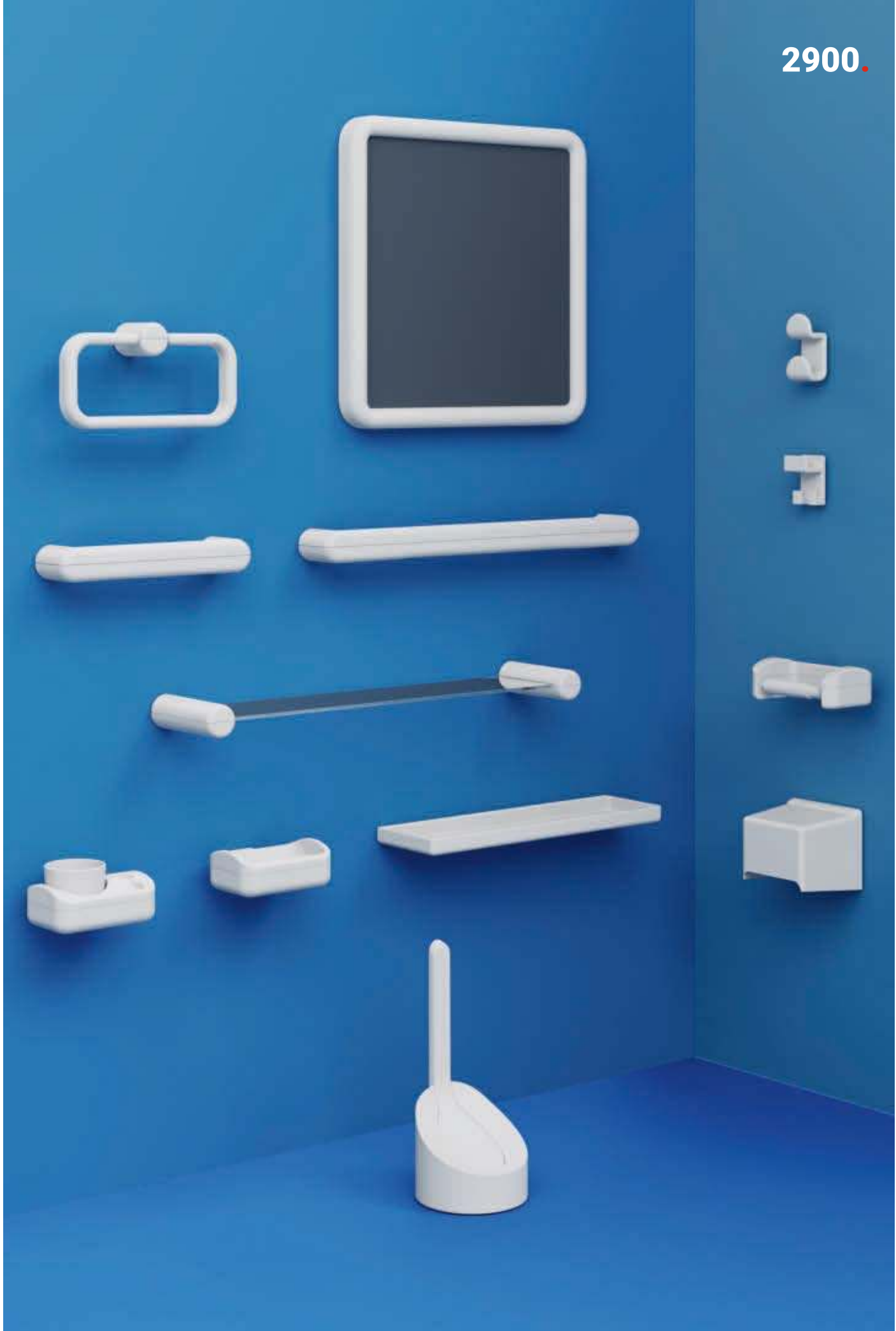

SERIE DA MURO . WALL LINES .

GEDY

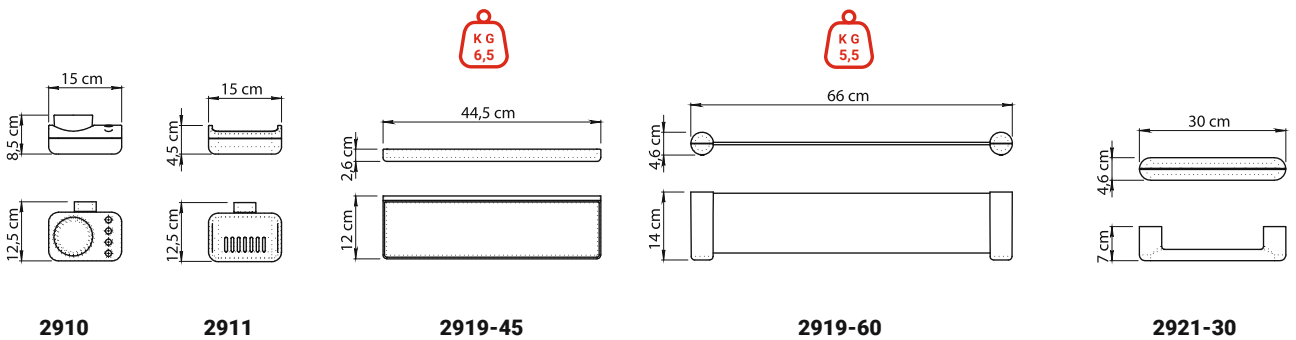

MoMA June 27, 1977
In permanent Design Collection
of the Museum of Modern Art
in New York



2900.

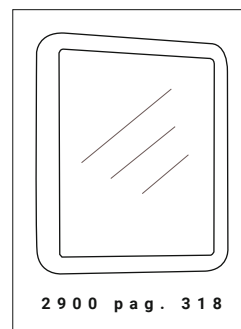
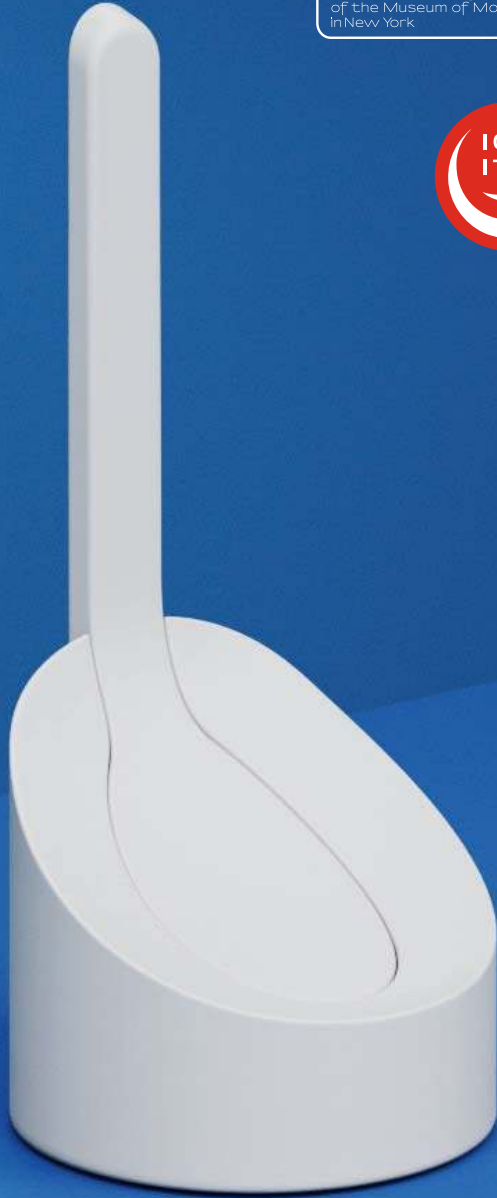

design **Ambrogio Rossari****

design **Olaf Von Bohr***

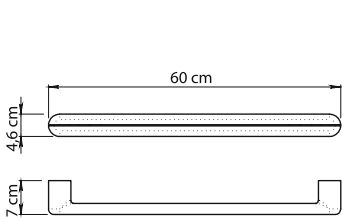

2921-60

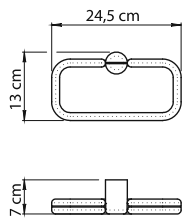

2970

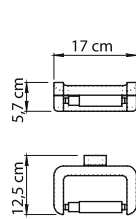

2924

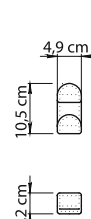

6027**

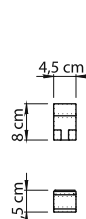

5027*

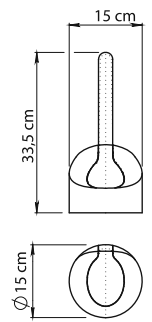

2033

GEDY

Junior.

design Gianpietro Tonetti

Realizzata in resine termoplastiche

Made of thermoplastic resins

Réalisée en résine thermoplastique

Hergestellt aus Kunststoff

Realizada en resinas termoplásticas

Изготовлено из термопластичных смол

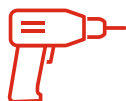

Con viti
With screws



Con ventosa
With suction cup

Solo su superfici lisce
(specchi, piastrelle)
For flat surfaces
(mirrors, tiles) only



GARANZIA
WARRANTY

100% MADE
in Italy



02
Bianco
White

Junior

SERIE DA MURO
Wall series

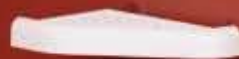

SERIE DA MURO WALL LINES

GEDY

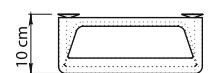
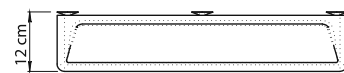
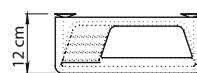
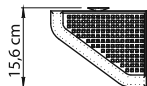
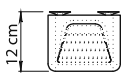
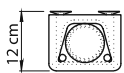
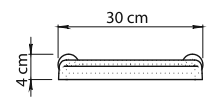
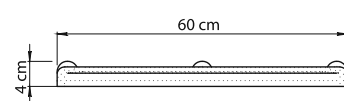
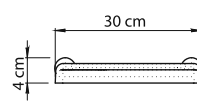
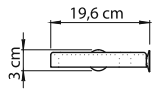
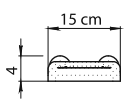
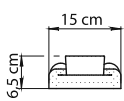

8010

8011

8080

8012

8019-60

8021-30

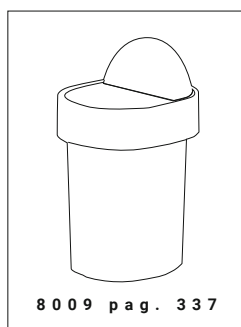
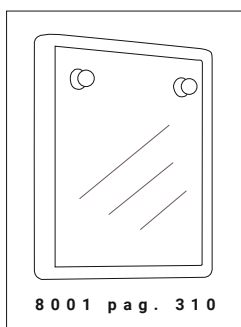

Solo con biadesivo o viti
Only with double tape sided
and screws*



Solo con viti
Only with screws**

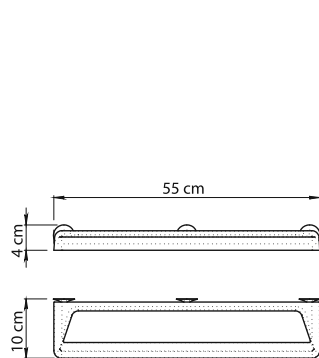

8021-55

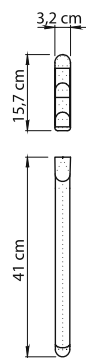

8023**

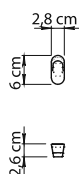

8026*

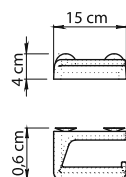

8024

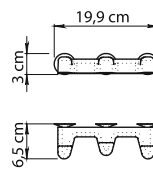

8028

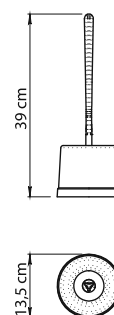

8033

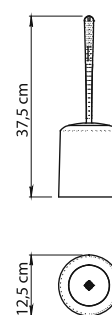

8034

GEDY

Vesuvio.

Realizzata in resine termoplastiche

Made of thermoplastic resins

Réalisée en résine thermoplastique

Hergestellt aus Kunststoff

Realizada en resinas termoplásticas

Изготовлено из термопластичных смол



Con ventosa

With suction cup

Solo su superfici lisce
(specchi, piastrelle)
For flat surfaces
(mirrors, tiles) only



GARANZIA
WARRANTY



02
Bianco
White

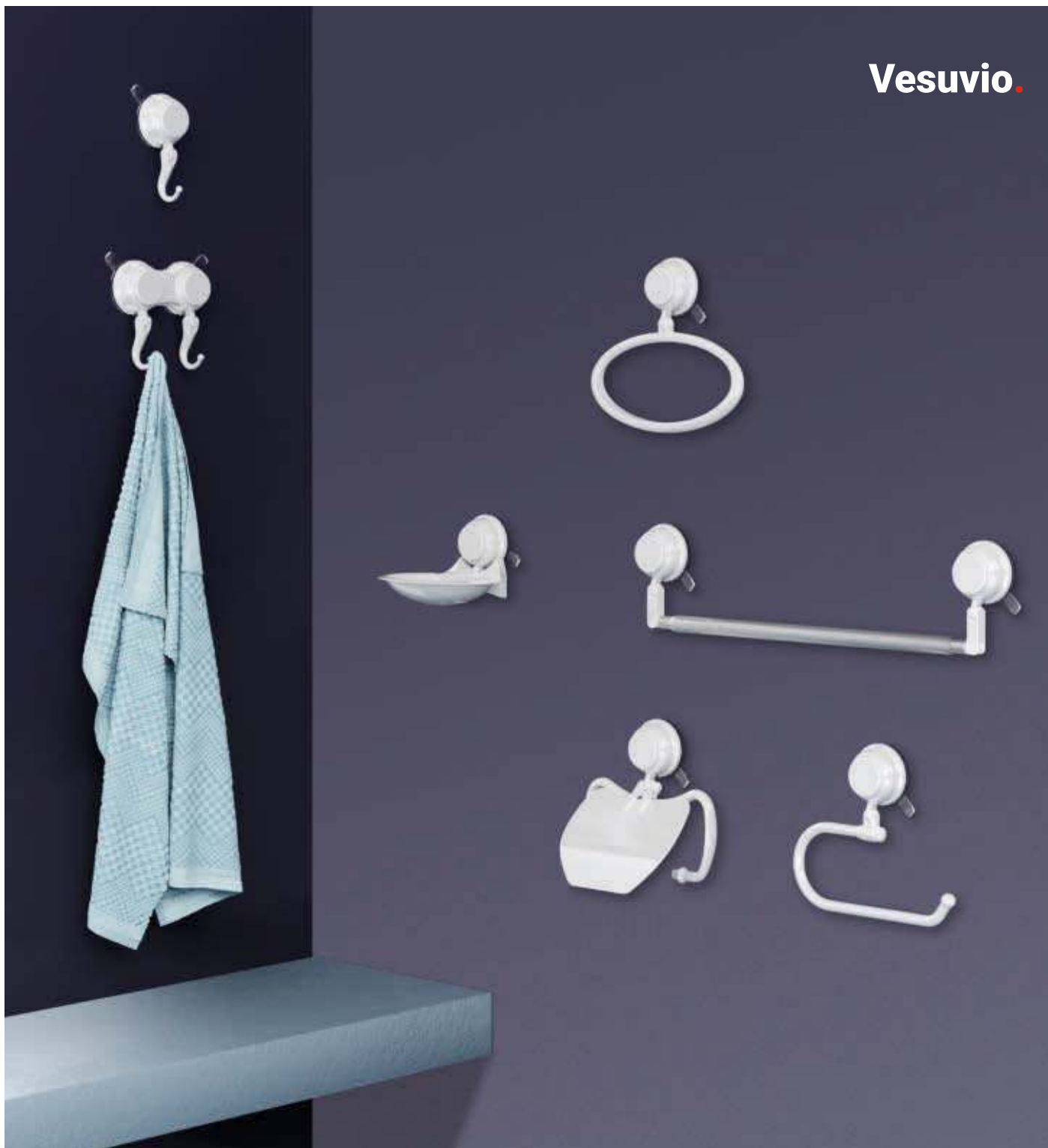

10/53

Attacco girevole Lunghezza estensibile
Swivel wall plate Adjustable length

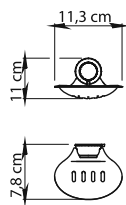

VS11

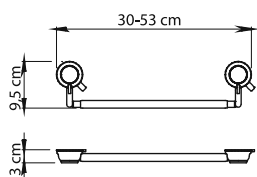

VS21-30

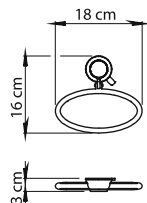

VS70

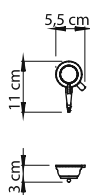

VS28

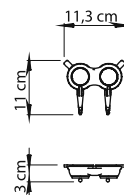

VS26

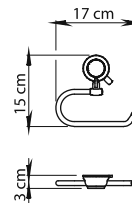

VS24

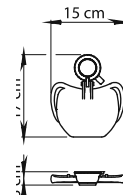

VS25

GEDY

bamboom

Himalaya.

NEW

Realizzata in bambù

Made of bamboo

Réalisée en bambou

Hergestellt aus Bambus

Realizada en bambù

Изготовлено из бамбука



Con viti

With screws



Natural



Bambù

Bamboo



Save

the planet



GARANZIA

WARRANTY



35

Naturale
Natural

Himalaya.

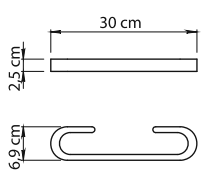
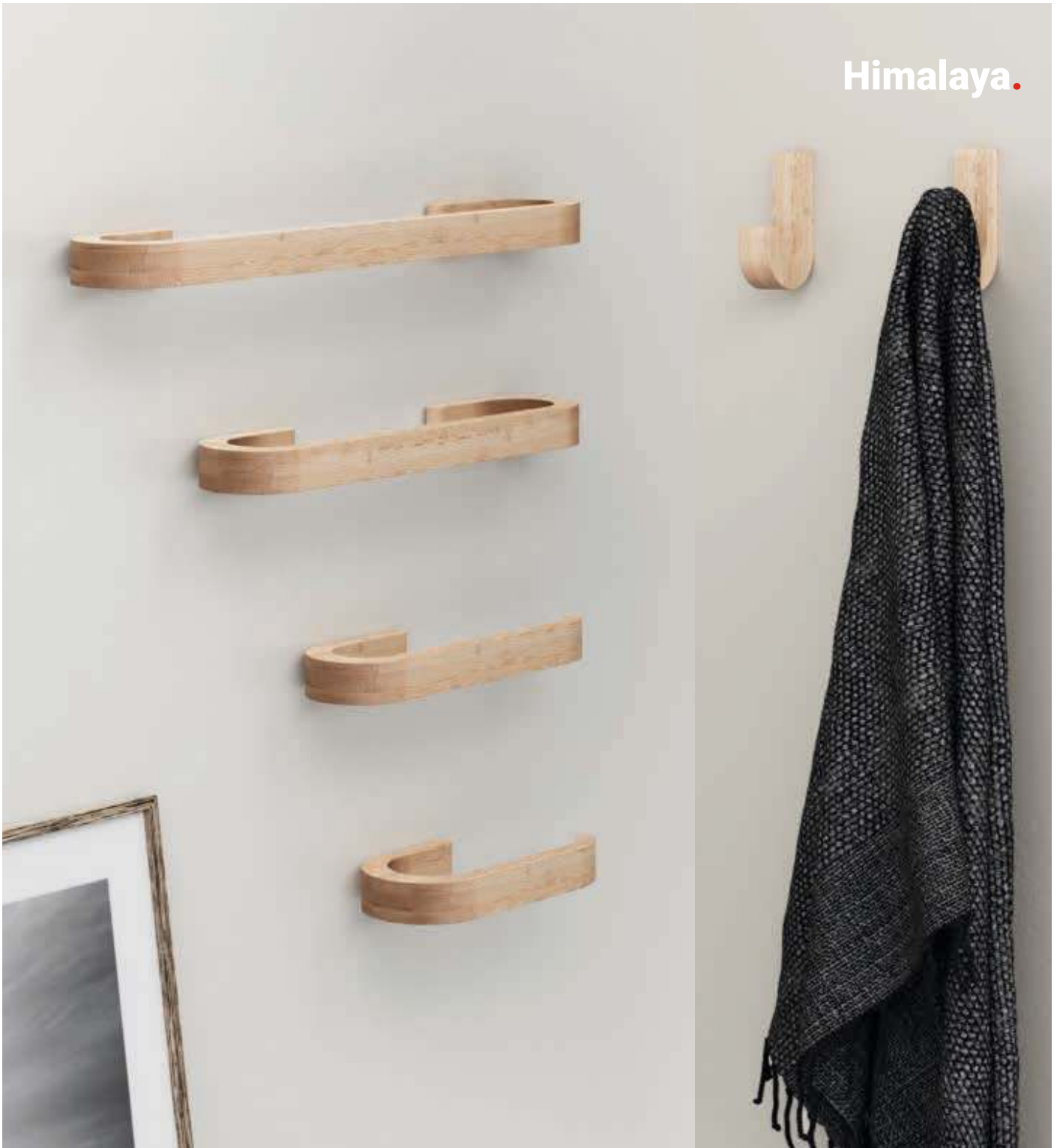

HY21-30

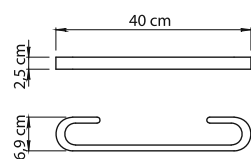

HY21-40

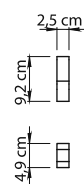

HY26
2 pz - 2 pcs

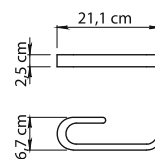

HY70

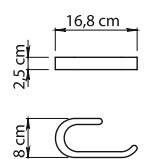

HY24



SERIE DA
APPOGGIO

Table top
series





SERIE DA APPOGGIO. TABLE TOP SERIES.

TOP DESIGN

Lounge.

Realizzata in alluminio con contenitori in vetro satinato

Made of aluminium with frosted glass containers

Réalisée en aluminium avec boîtiers en verre satiné

Hergestellt aus Aluminium mit Behältern aus satiniertem Glas

Realizada en aluminio con contenedores en cristal satinado

Изготовлено из латуни и ёмкостями из матового стекла



GARANZIA

WARRANTY



13
Cromato
Chromed



14
Nero matt
Matt black



5498

L7 x P7 x H10 cm



5451

L12 x P12 x H5 cm



5455

L6,8 x P9 x H15,9 cm

SERIE DA APPOGGIO. TABLE TOP SERIES.

GEDY

Elettra.

Realizzata in acciaio inox

Made of stainless steel

Réalisée en acier inoxydable

Hergestellt aus Edelstahl

Realizada en acero inox

Изготовлено из нержавеющей стали



15
Rame
Copper



EE98

ø 6,3 x H11,3 cm



EE11

L11 x P8 x H2 cm



EE80

ø 6,3 x H19 cm



EE33

ø 8 x H46,8 cm

SERIE DA APPOGGIO. TABLE TOP SERIES.

GEDY

Polaris.



13
Lucido
Polished

Realizzata in acciaio inox

Made of stainless steel

Réalisée en acier inoxydable

Hergestellt aus Edelstahl

Realizada en acero inox

Изготовлено из нержавеющей стали



PL98

L10 x P4,6 x H10 cm



PL11

L12,7 x P10 x H2,6 cm



PL80

L10 x P4,6 x H15,5 cm



PL33

L12,5 x P9,5 x H39,4 cm

SERIE DA APPOGGIO. TABLE TOP SERIES.

GEDY

Nemesia.

Realizzata in acciaio inox

Made of stainless steel

Réalisée en acier inoxydable

Hergestellt aus Edelstahl

Realizada en acero inox

Изготовлено из нержавеющей стали



13
Lucido
Polished



NE98

L6 x P6 x H10 cm



NE11

L11,8 x P11,8 x H2 cm



NE81

L6 x P6 x H18 cm



NE33

L9 x P9 x H38 cm



NE33 03

L9 x P9 x H38 cm

SERIE DA APPOGGIO. TABLE TOP SERIES.

GEDY

Betty.

Realizzata in acciaio inox e resine termoplastiche

Made of stainless steel and thermoplastic resins

Réalisée en acier inoxydable et résine thermoplastique

Hergestellt aus Edelstahl und Kunststoff

Realizada en acero inox y resinas termoplásticas

Изготовлено из нержавеющей стали и термопластиченых смол

13
Cromato
Chromed



BT98

ø 6,4 x H12,5 cm



BT11

ø 12 x H3,2 cm



BT81

L8,5 x P6,4 x H18,5



BT33

ø 9,3 x H38 cm

SERIE DA APPOGGIO. TABLE TOP SERIES.

GEDY

Primula.

Realizzata in acciaio inox

Made of stainless steel

Réalisée en acier inoxydable

Hergestellt aus Edelstahl

Realizada en acero inox

Изготовлено из нержавеющей стали



21

Lucido/spazzolato
Polished/brushed

SERIE DA APPOGGIO
Table top series



PR98

ø 7 x H10 cm



PR11

ø11,2 x H2 cm



PR81

ø5,5 x H19 cm



PR33

ø 10 x H38 cm

SERIE DA APPOGGIO. TABLE TOP SERIES.

GEDY

Nigella.

Realizzata in acciaio inox

Made of stainless steel

Réalisée en acier inoxydable

Hergestellt aus Edelstahl

Realizada en acero inox

Изготовлено из нержавеющей стали



38
Spazzolato
Brushed



NI98

ø 9 x H10 cm



NI11

ø 11 x H2,1 cm



NI81

ø 9 x H15,5 cm



NI33

ø 12,5 x H38,6 cm

SERIE DA APPOGGIO. TABLE TOP SERIES.

GEDY

Calipso.

Realizzata in cemento

Made of concrete

Réalisée en béton

Hergestellt aus Zement

Realizada en cemento

Изготовлено из бетона



08
Grigio
Grey



8798

ø 7,7 x H11,3 cm



8711

L11,8 x P7,5 x H2,6 cm



8780

ø 8,2 x H17,6 cm



8733

ø 10 x H48,7 cm

SERIE DA APPOGGIO. TABLE TOP SERIES.

GEDY

Giunone.

Realizzata in cemento

Made of concrete

Réalisée en béton

Hergestellt aus Zement

Realizada en cemento

Изготовлено из бетона



08
Grigio
Grey



4198

ø 8,2 x H9,3 cm



4111

ø 11,5 x H2,4 cm



4180

ø 8,2 x H17,5 cm



4106

L27,5 x P15,5 x H2,8 cm



4133

ø 10,3 x H46,5 cm

SERIE DA APPOGGIO. TABLE TOP SERIES.

bambocom®

GEDY

Afrodite.

Realizzata in cemento e bambù

Made of concrete and bamboo

Réalisée en béton et bambou

Hergestellt aus Zement und Bambus

Realizada en cementoy bambú

Изготовлено из бетона и бамбука



Natural



Bambù

Bamboo



Save
the planet



08
Grigio
Grey



4998

ø 7,5 x H11,5 cm



4911

L12,8 x P8,4 x H3 cm



4980

ø 7,6 x H17,2 cm



4906

L30,5 x P10,4 x H3,2 cm



4933

ø 9,3 x H47 cm

SERIE DA APPOGGIO. TABLE TOP SERIES.

bambocom®

GEDY

Dafne.

Realizzata in bambù

Made of bamboo

Réalisée en bambou

Hergestellt aus Bambus

Realizada en bambú

Изготовлено из бамбука



Natural



Bambù

Bamboo



Save

the planet



30

Noce

Walnut colour



3998

L8 x P8 x H13 cm



3911

L14 x P8 x H2,2 cm



3980

L8 x P8 x H18,5 cm



3933

L9,5 x P9,5 x H47 cm

SERIE DA APPOGGIO. TABLE TOP SERIES.

bambocom®

GEDY

Altea.

Realizzata in bambù

Made of bamboo

Réalisée en bambou

Hergestellt aus Bambus

Realizada en bambú

Изготовлено из бамбука



Natural



Bambù

Bamboo



Save
the planet



35
Naturale
Natural



AL98

ø 7 x H12 cm



AL11

ø 11,7 x H2 cm



AL80

ø 7 x H17,2 cm



AL33

ø 8,5 x H47,5 cm

SERIE DA APPOGGIO. TABLE TOP SERIES.

bambocom®

GEDY

Bonnie.

NEW



41

Naturale/nero matt
Natural/matt black

Realizzata in bambù

Made of bamboo

Réalisée en bambou

Hergestellt aus Bambus

Realizada en bambú

Изготовлено из бамбука

Natural

Bambù

Bamboo

Save
the planet



35
Naturale
Natural



BN98

L7,4 x P7,4 x H11 cm



35
Naturale
Natural



BN11

L13,4 x P9,6 x H2,5 cm



BN80

L7,4 x P7,4 x H16,8 cm



BN33

L10 x P10 x H36,5 cm



BN34

L10 x P10 x H39,5 cm

SERIE DA APPOGGIO. TABLE TOP SERIES.

GEDY

Cixi.

NEW

design Eric Bevilacqua

Realizzata in porcellana

Made of porcelain

Réalisée en porcelaine

Hergestellt aus Porzellan

Realizada en porcelana

Изготовлено из фарфор

PORCELLANA
PORCELAIN



89
Bianco/Blu
White/Blue



CX98

L7,5 x P7,5 x H11,5 cm



CX11

L10,5 x P10,5 x H3 cm



CX81

L7,5 x P9,5 x H17 cm



CX33

L11,5 x P11,5 x H44,5 cm

SERIE DA APPOGGIO. TABLE TOP SERIES.

GEDY

Myosotis.

Realizzata in ceramica e vetro

Made of pottery and glass

Réalisée en céramique et verre

Hergestellt aus Keramik und Glas

Realizada en cerámica y cristal

Изготовлено из керамики и стекла



03
Crema/oro
Cream/gold



73
Argento
Silver



MY98

ø 8,5 x H11,3 cm



MY11

L14 x P10 x H3,9 cm



MY80

ø 8,5 x H19 cm



MY33

ø 12,5 x H46 cm

SERIE DA APPOGGIO. TABLE TOP SERIES.

GEDY

Marina.

Realizzata in ceramica e madreperla

Made of pottery and conch

Réalisée en céramique et nacre

Hergestellt aus Keramik und Perlmutter

Realizada en cerámica y nácar

Изготовлено из керамики и перламутра



03
Crema
Cream



MR98

ø 8,5 x H11,3 cm



MR11

L14 x P10 x H3,9 cm



MR80

ø 8,5 x H19 cm



MR33

ø 12,5 x H46 cm

SERIE DA APPOGGIO. TABLE TOP SERIES.

GEDY

Amelie.

Realizzata in ceramica

Made of pottery

Réalisée en céramique

Hergestellt aus Keramik

Realizada en cerámica

Изготовлено из керамики



02
Bianco
White



AM98

L8 x P8 x H11,3 cm



AM11

L13,5 x P8 x H5,8 cm



AM80

L7,5 x P7,5 x H19 cm



AM33

L10,4 x P10,4 x H48,5 cm

SERIE DA APPOGGIO. TABLE TOP SERIES.

GEDY

Lucrezia.

Realizzata in ceramica

Made of pottery

Réalisée en céramique

Hergestellt aus Keramik

Realizada en cerámica

Изготовлено из керамики



02
Bianco
White



LC98

L7 x P7 x H11 cm



LC11

L13 x P10 x H2,2 cm



LC80

L7 x P7 x H17,5 cm



LC33

L10 x P10 x H46 cm

SERIE DA APPOGGIO. TABLE TOP SERIES.

GEDY

Clothilde.

Realizzata in ceramica

Made of pottery

Réalisée en céramique

Hergestellt aus Keramik

Realizada en cerámica

Изготовлено из керамики



02
Bianco
White



CI98

ø 7,2 x H11,8 cm



CI11

L12,7 x P8,8 x H2,9 cm



CI80

ø 7,2 x H20 cm



CI33

ø 9,6 x H46 cm

SERIE DA APPOGGIO. TABLE TOP SERIES.

GEDY

Astrid.

Realizzata in ceramica

Made of pottery

Réalisée en céramique

Hergestellt aus Keramik

Realizada en cerámica

Изготовлено из керамики



73
Argento
Silver



87
Oro
Gold



AD98

ø 8,3 x H11 cm



AD11

ø 12 x H2,6 cm



AD80

ø 8,3 x H16,6 cm



AD33

ø 11,5 x H47 cm

SERIE DA APPOGGIO. TABLE TOP SERIES.

GEDY

New Mizar.

Realizzata in ceramica

Made of pottery

Réalisée en céramique

Hergestellt aus Keramik

Realizada en cerámica

Изготовлено из керамики



NM98

ø 6,4 x H10,8 cm



NM11

L12,3 x P9 x H3 cm



NM80

ø 6,4 x H19,2 cm



NM33

ø 9,7 x H47,5 cm



08
Grigio
Grey



52
Tortora
Turtledove grey



66
Tortora chiaro
Light
turtledove grey



SERIE DA APPOGGIO. TABLE TOP SERIES.

GEDY

Lucy.



02
Bianco
White

Realizzata in ceramica

Made of pottery

Réalisée en céramique

Hergestellt aus Keramik

Realizada en cerámica

Изготовлено из керамики



LY98

L7,3 x P7,3 x H10,3 cm



LY11

L12 x P8,2 x H3 cm



LY80

L7,3 x P7,3 x H17,5 cm



LY33

L9,7 x P9,7 x H47 cm

SERIE DA APPOGGIO. TABLE TOP SERIES.

GEDY

Catherine.

Realizzata in ceramica

Made of pottery

Réalisée en céramique

Hergestellt aus Keramik

Realizada en cerámica

Изготовлено из керамики



02
Bianco
White



CT98

ø 7,7 x H12 cm



CT11

L13 x P7,8 x H1,8 cm



CT80

ø 7,7 x H19 cm



CT33

ø 9,8 x H40 cm

SERIE DA APPOGGIO. TABLE TOP SERIES.

GEDY

New Martina.

Realizzata in ceramica

Made of pottery

Réalisée en céramique

Hergestellt aus Keramik

Realizada en cerámica

Изготовлено из керамики



02
Bianco
White



73
Argento
Silver



MT98

L7,5 x P7,5 x H11 cm



MT11

L13 x P9 x H2,3 cm



MT80

L7,5 x P7,5 x H16 cm



MT33

L9 x P9 x H47 cm

SERIE DA APPOGGIO. TABLE TOP SERIES.

GEDY

Naomi.

Realizzata in ceramica

Made of pottery

Réalisée en céramique

Hergestellt aus Keramik

Realizada en cerámica

Изготовлено из керамики



08
Grigio
Grey



14
Nero
Black



N098

ø 7,5 x H11,5 cm



N011

L13 x P9 x H2,5 cm



N080

ø 7,5 x H18,5 cm



N033

ø 9 x H45,5 cm

SERIE DA APPOGGIO. TABLE TOP SERIES.

GEDY

Marika.

Realizzata in ceramica

Made of pottery

Réalisée en céramique

Hergestellt aus Keramik

Realizada en cerámica

Изготовлено из керамики



MK98

ø 8 x H11,6 cm



MK11

L12 x P8,3 x H3 cm



MK80

ø 8 x H18 cm



MK33

ø 10,2 x H45 cm



02
Bianco
White



07
Verde salvia
Green sage



08
Grigio
Grey



SERIE DA APPOGGIO. TABLE TOP SERIES.

GEDY

Vivienne.

Realizzata in ceramica

Made of pottery

Réalisée en céramique

Hergestellt aus Keramik

Realizada en cerámica

Изготовлено из керамики



02
Bianco
White



05
Blu
Blue



VV98

L9,5 x P6 x H10,5 cm



VV11

L13 x P8,4 x H3,2 cm



VV80

L8,7 x P6 x H18 cm



VV33

L9 x P9 x H47 cm

SERIE DA APPOGGIO. TABLE TOP SERIES.

GEDY

Ilary.

Realizzata in ceramica e sughero

Made of pottery and cork

Réalisée en céramique et liège

Hergestellt aus Keramik und Kork

Realizada en cerámica y corcho

Изготовлено из керамики и пробки



02
Bianco
White



14
Nero matt
Matt black



IL98

ø 7 x H10,5 cm



IL11

L13 x P9,5 x H3 cm



IL80

ø 7 x H17 cm



IL33

ø 8,8 x H46,5 cm

SERIE DA APPOGGIO. TABLE TOP SERIES.

GEDY

Chantal.

Realizzata in ceramica

Made of pottery

Réalisée en céramique

Hergestellt aus Keramik

Realizada en cerámica

Изготовлено из керамики



14
Nero matt
Matt black



CN98

ø 7 x H12 cm



CN11

L12,8 x P8,3 x H2,5 cm



CN80

ø 7 x H20,6 cm



CN33

ø 11,5 x H46,5 cm

SERIE DA APPOGGIO. TABLE TOP SERIES.

GEDY

Sabina.

Realizzata in ceramica

Made of pottery

Réalisée en céramique

Hergestellt aus Keramik

Realizada en cerámica

Изготовлено из керамики



27

Acquamarina
Aquamarine

SERIE DA APPOGGIO
Table top series

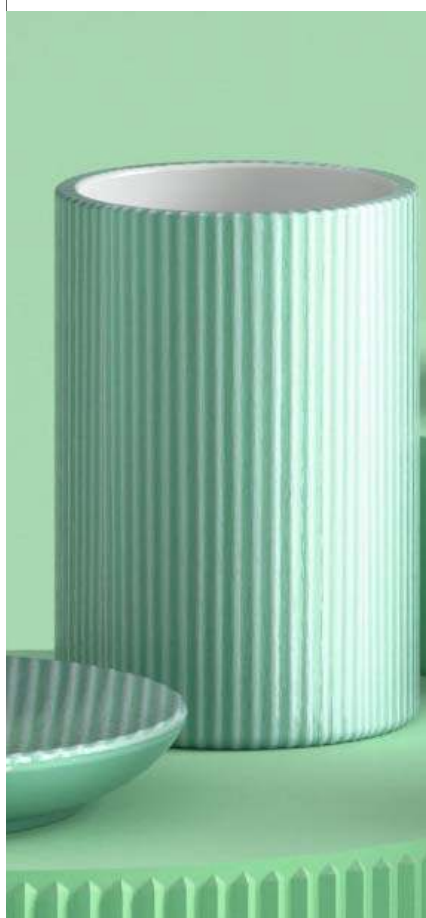

SA98

ø 7,5 x H11 cm



SA11

ø 12 x H2 cm



SA80

ø 7,5 x H19 cm



SA33

ø 9,3 x H46 cm

SERIE DA APPOGGIO. TABLE TOP SERIES.

GEDY

Wilma.

NEW

Realizzata in ceramica

Made of pottery

Réalisée en céramique

Hergestellt aus Keramik

Realizada en cerámica

Изготовлено из керамики



07
Verde salvia
Sage green



WL98

ø 10 x H10 cm



WL11

ø 12,2 x H3 cm



WL80

ø 10 x H15,5 cm



WL03

ø 9,5 x H12,5 cm



WL33

ø 13 x H41 cm

SERIE DA APPOGGIO. TABLE TOP SERIES.

GEDY

Azalea.

Realizzata in ceramica

Made of pottery

Réalisée en céramique

Hergestellt aus Keramik

Realizada en cerámica

Изготовлено из керамики



02
Bianco
White



79
Lilla
Lilac



AZ98

ø 9,8 x H13 cm



AZ11

L12,4 x P9 x H2,7 cm



AZ80

ø 10,2 x H17 cm



AZ33

ø 16,5 x H40,3 cm

SERIE DA APPOGGIO. TABLE TOP SERIES.

GEDY

Alexia.



02
Bianco
White

Realizzata in ceramica

Made of pottery

Réalisée en céramique

Hergestellt aus Keramik

Realizada en cerámica

Изготовлено из керамики



AX98

ø 9 x H10 cm



AX11

L14 x P6,5 x H2,5 cm



AX80

ø 9 x H17 cm



AX33

ø 12,5 x H36,5 cm

SERIE DA APPOGGIO. TABLE TOP SERIES.

GEDY

Dalia.

Realizzata in ceramica

Made of pottery

Réalisée en céramique

Hergestellt aus Keramik

Realizada en cerámica

Изготовлено из керамики



02
Bianco
White



DA98

ø 8,1 x H10,6 cm



DA11

ø 12,5 x H3,2 cm



DA80

ø 9 x H17,8 cm



DA33

ø 12,5 x H38 cm

SERIE DA APPOGGIO. TABLE TOP SERIES.

GEDY

Petunia.



02
Bianco
White

Realizzata in ceramica e acciaio inox

Made of pottery and stainless steel

Réalisée en céramique et acier inoxydable

Hergestellt aus Keramik und Edelstahl

Realizada en cerámica y acero inox

Изготовлено из керамики и нержавеющей стали



PE98

ø 7,5 x H9,5 cm



PE11

L12,5 x P8,5 x H3,5 cm



PE81

ø 7,5 x H16,5 cm



PE33

ø 9 x H44,8 cm

SERIE DA APPOGGIO. TABLE TOP SERIES.

GEDY

Karima.

Realizzata in ceramica

Made of pottery

Réalisée en céramique

Hergestellt aus Keramik

Realizada en cerámica

Изготовлено из керамики



02
Bianco
White



KR98

L7,5 x P7,5 x H11,6 cm



KR11

L13,5 x P9,7 x H2,7 cm



KR80

L7,5 x P7,5 x H17 cm



KR33

L10,6 x P10,6 x H43,5 cm

SERIE DA APPOGGIO. TABLE TOP SERIES.

GEDY

Kelly.

Realizzata in ceramica

Made of pottery

Réalisée en céramique

Hergestellt aus Keramik

Realizada en cerámica

Изготовлено из керамики



KY98

L7,2 x P7,2 x H10 cm



KY11

L10 x P10 x H3 cm



KY80

L7,2 x P7,2 x H16,3 cm



KY33

L10,3 x P10,3 x H40 cm



02
Bianco
White



08
Grigio
Grey



14
Nero
Black



66
Tortora chiaro
Light
turtledove grey



87
Oro
Gold



SERIE DA APPOGGIO. TABLE TOP SERIES.

GEDY

Verbena.



02
Bianco
White

Realizzata in ceramica

Made of pottery

Réalisée en céramique

Hergestellt aus Keramik

Realizada en cerámica

Изготовлено из керамики



VE98

L6,5 x P6,5 x H10 cm



VE11

L11,5 x P8,5 x H2,5 cm



VE81

L6,5 x P6,5 x H16,5 cm



VE33

L7,8 x P7,8 x H45,6 cm

SERIE DA APPOGGIO. TABLE TOP SERIES.

GEDY

Nicole.

Realizzata in vetro e silicone

Made of glass and silicone

Réalisée en verre en silicone

Hergestellt aus Glas und Silikon

Realizada en cristal y silicona

Изготовлено из стекла и силикон



05
Blu
Blue



07
Verde
Green



NC98

ø 8,4 x H10,3 cm



NC80

ø 8,4 x H12,8 cm



NC33

ø 9,5 x H37 cm

SERIE DA APPOGGIO. TABLE TOP SERIES.

GEDY

Corinne.

Realizzata in vetro

Made of glass

Réalisée en verre

Hergestellt aus Glas

Realizada en cristal

Изготовлено из стекла



CR98

ø 7,9 x H9,8 cm



CR11

L13 x P9,3 x H2,4 cm



CR80

L8 x P8,9 x H15,6 cm



CR33

ø 9,1 x H35 cm



00
**Trasparente
fumé**
Transparent
smoked



05
Blu
Blue



07
Verde
Green



SERIE DA APPOGGIO. TABLE TOP SERIES.

GEDY

Gioia.

NEW

Realizzata in vetro

Made of glass

Réalisée en verre

Hergestellt aus Glas

Realizada en cristal

Изготовлено из стекла



GO80 10

ø 7,5 x H18,8 cm



GO80 20

ø 7,5 x H18,8 cm



GO80 30

ø 7,5 x H18,8 cm

SERIE DA APPOGGIO. TABLE TOP SERIES.

bambocom®

GEDY

Ninfea.

Realizzata in resina e bambù

Made of resin and bamboo

Réalisée en résine et bambou

Hergestellt aus Harz und Bambus

Realizada en resina y bambú

Изготовлено из бамбука и смол



Natural



Bambù
Bamboo



Save
the planet



02
Bianco matt
Matt white



14
Nero matt
Matt black



1398

L12,8 x P5,6 x H8,5 cm



1311

L12,8 x P8,2 x H3 cm



1380

L12,8 x P5,6 x H15,7 cm



35
Naturale
Natural



1306

L29,7 x P15,2 x H2 cm



1333

L9,3 x P9,3 x H46,2 cm

SERIE DA APPOGGIO. TABLE TOP SERIES.

bambocom®

GEDY

Thea.

NEW

Realizzata in bambù e resina

Made of bamboo and resin

Réalisée en bambou et résine

Hergestellt aus Bambus und Harz

Realizada en bambú y resina

Изготовлено из бамбука и бамбука



Natural



Bambù

Bamboo



Save

the planet



47

Naturale/Verde
Natural/Green



07
Verde
Green



TH98

ø 7,5 x H10,5 cm



TH11

ø 12 x H2,3 cm



TH80

ø 7,5 x P8,5 x H15 cm



TH03

ø 9,5 x H7,3 cm



TH06

L27,5 x P11,8 x H1,5 cm



TH33

ø 9,5 x H35 cm



35
Naturale
Natural

SERIE DA APPOGGIO. TABLE TOP SERIES.

GEDY

Iside.

design Studio Original Designers65 Network

Realizzata in resina e sabbia

Made of resin and sand

Réalisée en résine et sable

Hergestellt aus Harz und Sand

Realizada en resina y arena

Изготовлено из бамбука и песка



02

Bianco lucido
Polished white



14

Nero matt
Matt black



1898

L8,1 x P7,9 x H13,7 cm



1811

L15,2 x P11,5 x H2,9 cm



1881

L8,3 x P8,1 x H17,4 cm



1833

L11,8 x P11,5 x H46,2 cm

SERIE DA APPOGGIO. TABLE TOP SERIES.

GEDY

Sofia.

Realizzata in resina e sabbia

Made of resin and sand

Réalisée en résine et sable

Hergestellt aus Harz und Sand

Realizada en resina y arena

Изготовлено из бамбука и песка



02
Bianco lucido
Polished white



14
Nero matt
Matt black



SF98

L7,3 x P7,3 x H11,3 cm



SF11

L11 x P7 x H2,9 cm



SF80

L7,1 x P7,1 x H16,3 cm



SF33

L9,3 x P9,3 x H43,7 cm

SERIE DA APPOGGIO. TABLE TOP SERIES.

GEDY

Libra.

Realizzata in resina e sabbia

Made of resin and sand

Réalisée en résine et sable

Hergestellt aus Harz und Sand

Realizada en resina y arena

Изготовлено из бамбука и песка



03
Beige



LB98

L8,2 x P8,4 x H10,4 cm



LB11

L14,7 x P14 x H3,2 cm



LB81

L9,6 x P10,7 x H17,5 cm



LB33

L12,1 x P12,5 x H41,6 cm

SERIE DA APPOGGIO. TABLE TOP SERIES.

GEDY

Aries.

Realizzata in resina e sabbia

Made of resin and sand

Réalisée en résine et sable

Hergestellt aus Harz und Sand

Realizada en resina y arena

Изготовлено из бамбука и песка



AR98

L9,2 x P6,5 x H11 cm



AR11

L12,2 x P8,6 x H2,4 cm



AR80

L9 x P6,4 x H16,8 cm



AR33

L10,5 x P10,5 x H40 cm



03
Beige



08
Grigio
Grey



85
Antracite
Anthracite



SERIE DA APPOGGIO. TABLE TOP SERIES.

GEDY

Zoe.

NEW



20

Graniglia marmo
bianco/nero
Grit marble
white/black

Realizzata in resina e pietra

Made of resin and stone

Réalisée en résine et pierre

Hergestellt aus Harz und Steiner

Realizada en resina y piedra

Изготовлено из смолы и камней



Z098

L7,4 x P7,4 x H11,3 cm



Z011

L11,5 x P7 x H 3 cm



Z080

L7 x P8,2 x H16,2 cm



Z033

L9,8 x P9,8 x H44 cm

SERIE DA APPOGGIO. TABLE TOP SERIES.

GEDY

Irina.

design Simone Micheli

Realizzata in resina

Made of resin

Réalisée en résine

Hergestellt aus Harz

Realizada en resina

Изготовлено из бамбука



02
Bianco
White



IN98

ø 10 x H11,5 cm



IN11

L12 x P12 x H2,5 cm



IN80

ø 9,5 x H15,5 cm



IN33

ø 11 x H46 cm

SERIE DA APPOGGIO. TABLE TOP SERIES.

GEDY

Twist.

design Babled & Co.

Realizzata in resina

Made of resin

Réalisée en résine

Hergestellt aus Harz

Realizada en resina

Изготовлено из бамбука



4698

L8,5 x P8,5 x H12 cm



4611

L13 x P9 x H3,5 cm



4681

L8,5 x P8,5 x H17,5 cm



4633

L12 x P13,5 x H47 cm



SERIE DA APPOGGIO. TABLE TOP SERIES.

GEDY

Chanelle.

Realizzata in resina

Made of resin

Réalisée en résine

Hergestellt aus Harz

Realizada en resina

Изготовлено из бамбука



CH98

L9 x P7 x H10,5 cm



CH11

L12 x P7,8 x H2,8 cm



CH80

L12 x P7 x H12,6 cm



CH33

L10,6 x P8,6 x H45,7 cm



02
Bianco
White



07
Verde menta
Green mint



10
Rosa
Pink



37
Pesca
Peach color



66
Tortora chiaro
Light
turtledove grey



SERIE DA APPOGGIO. TABLE TOP SERIES.

GEDY

Antares.

Realizzata in resina

Made of resin

Réalisée en résine

Hergestellt aus Harz

Realizada en resina

Изготовлено из бамбука



AT98

L8 x P6,2 x H11,7 cm



AT11

L11,2 x P7,5 x H2,7 cm



AT80

L8 x P6,2 x H15,5 cm



AT33

L8,7 x P8 x H47 cm

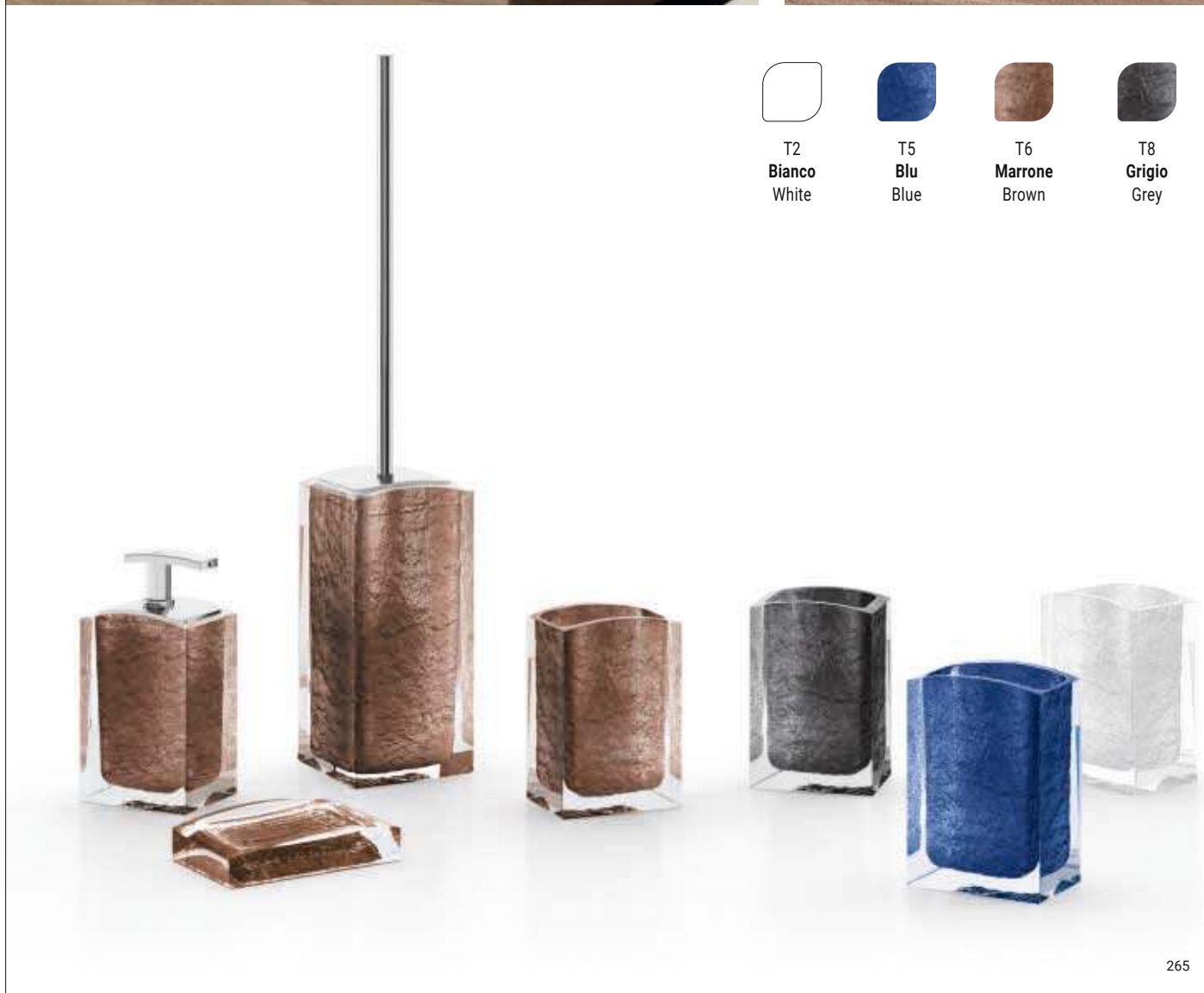

T2
Bianco
White



T5
Blu
Blue



T6
Marrone
Brown



T8
Grigio
Grey

SERIE DA APPOGGIO. TABLE TOP SERIES.

GEDY

Rainbow.

Realizzata in resina

Made of resin

Réalisée en résine

Hergestellt aus Harz

Realizada en resina

Изготовлено из бамбука



02
Bianco
White



04
Verde acido
Acid green



05
Blu
Blue



06
Rosso
Red



07
Verde menta
Green mint



10
Rosa
Pink



14
Nero
Black



67
Arancione
Orange



73
Argento
Silver



79
Lilla
Lilac



52
Tortora
Turtledove grey



65
Blu petrolio
Petrol blue



66
Tortora chiaro
Light
turtledove grey



86
Celeste
Sky blue



RA98
L7,2 x P7,2 x H11 cm



RA11
L11 x P7 x H3 cm



RA81
L7 x P7 x H16,2 cm



RA33
L9,8 x P9,8 x H37,5 cm



- 02
- 04
- 05
- 06
- 14
- 67
- 73
- 79



RA80

L7 x P11,3 x H17,2 cm

- 02
- 04
- 05
- 06
- 14
- 67
- 73
- 79
- 52
- 66



RA00

L19 x P11 x H7,5 cm

- 04
- 67



RA08

L25 x P13,5 x H7,5 cm

SERIE DA APPOGGIO. TABLE TOP SERIES.

GEDY

Giulia.

Realizzata in resina

Made of resin

Réalisée en résine

Hergestellt aus Harz

Realizada en resina

Изготовлено из бамбука



T6
Marrone
Brown



GU98

L7 x P7 x H11 cm



GU11

L10,6 x P6,8 x H2 cm



GU80

L7 x P7 x H16 cm



GU33

L9,2 x P9,2 x H46 cm

SERIE DA APPOGGIO. TABLE TOP SERIES.

GEDY

Idra.

Realizzata in resina

Made of resin

Réalisée en résine

Hergestellt aus Harz

Realizada en resina

Изготовлено из бамбука



03
Beige



ID98

ø 10,2 x H10,4 cm



ID11

L12,3 x P9 x H2,7 cm



ID80

ø 10,6 x H15,5 cm



ID33

ø 12,2 x H40 cm

SERIE DA APPOGGIO. TABLE TOP SERIES.

GEDY

Gemini.

Realizzata in resina

Made of resin

Réalisée en résine

Hergestellt aus Harz

Realizada en resina

Изготовлено из бамбука



GM98

ø 8,7 x H11,1 cm



GM11

L14 x P9,6 x H2,8 cm



GM80

L8,6 x P9,4 x H20,7 cm



GM33

ø 9,9 x H45,7 cm



02
Bianco
White



08
Grigio
Grey



52
Tortora
Turtledove grey



SERIE DA APPOGGIO. TABLE TOP SERIES.

GEDY

Quadrotto.

Realizzata in resina

Made of resin

Réalisée en résine

Hergestellt aus Harz

Realizada en resina

Изготовлено из бамбука



QU98

L10 x P6,5 x H11,2 cm



QU11

L11,2 x P11,2 x H2,4 cm



QU81

L8,2 x P8,2 x H16 cm



QU33

L9,5 x P9,5 x H46 cm



02
Bianco
White



08
Grigio
Grey



14
Nero
Black



66
Tortora chiaro
Light
turtledove grey

SERIE DA APPOGGIO. TABLE TOP SERIES.

GEDY

Sole.

Realizzata in resina

Made of resin

Réalisée en résine

Hergestellt aus Harz

Realizada en resina

Изготовлено из бамбука



SL98

ø 7,2 x H12,2 cm



SL11

ø 11 x H2,9 cm



SL80

L7,2 x P7,5 x H15,7 cm



SL33

ø 9,8 x H40 cm



SERIE DA APPOGGIO. TABLE TOP SERIES.

GEDY

Vega.



73
Argento
Silver

Realizzata in resina

Made of resin

Réalisée en résine

Hergestellt aus Harz

Realizada en resina

Изготовлено из бамбука



VG98

ø 7 x H12 cm



VG11

ø 11 x H2,5 cm



VG80

ø 7 x H15,7 cm

SERIE DA APPOGGIO. TABLE TOP SERIES.

GEDY

Kira.

NEW



02

Bianco matt
Matt white

Realizzata in resina

Made of resin

Réalisée en résine

Hergestellt aus Harz

Realizada en resina

Изготовлено из бамбука



KI98

ø 8,4 x H11,3 cm



KI11

ø 11,3 x H2,2 cm



KI80

L10,8 x P10,6 x H13,6 cm



KI33

ø 10,4 x H42 cm

SERIE DA APPOGGIO. TABLE TOP SERIES.

GEDY

Layla.

NEW



02
Bianco
White

Realizzata in resina

Made of resin

Réalisée en résine

Hergestellt aus Harz

Realizada en resina

Изготовлено из бамбука



LL98

L7,7 x P7,5 x H10,8 cm



LL11

L13,4 x P9,5 x H22 cm



LL80

L8,5 x P7,5 x H18,3 cm



LL33

L9,4 x P9,4 x H41,5 cm

SERIE DA APPOGGIO. TABLE TOP SERIES.

GEDY

Yvonne.

Realizzata in resina

Made of resin

Réalisée en résine

Hergestellt aus Harz

Realizada en resina

Изготовлено из бамбука



08
Grigio
Grey



YV98

L9,3 x P9,6 x H9 cm



YV11

L11,7 x P11,8 x H2,3 cm



YV80

L10,8 x P12 x H14,4 cm



YV33

L15 x P12,5 x H38 cm



YV34

L15 x P12,5 x H43,5 cm

SERIE DA APPOGGIO. TABLE TOP SERIES.

GEDY

Helen.

NEW

Realizzata in resina

Made of resin

Réalisée en résine

Hergestellt aus Harz

Realizada en resina

Изготовлено из бамбука



HE98

ø 7,2 x H10 cm



HE11

L13 x P9 x H2,5 cm



HE80

L8,5 x ø 7,5 x H17 cm



HE33

ø 9,5 x H42,5 cm



02
Bianco
White



08
Grigio
Grey



14
Nero
Black



SERIE DA APPOGGIO. TABLE TOP SERIES.

GEDY

Petra.

Realizzata in resina

Made of resin

Réalisée en résine

Hergestellt aus Harz

Realizada en resina

Изготовлено из бамбука



08
Grigio
Grey



PT98

ø 7,5 x H11 cm



PT11

L13,7 x P10 x H2,4 cm



PT80

ø 7,5 x H15,8 cm



PT33

ø 9 x H44,5 cm

SERIE DA APPOGGIO. TABLE TOP SERIES.

GEDY

Brenda.

NEW



14
Nero matt
Matt black

Realizzata in resina

Made of resin

Réalisée en résine

Hergestellt aus Harz

Realizada en resina

Изготовлено из бамбука



BR98

ø 7 x H10 cm



BR11

L13,7 x P9,8 x H2,8 cm



BR80

L9,2 x P7 x H16,3 cm



BR06

L21,5 x P15,2 x H2,5 cm



BR03

ø 10 x H9,5 cm



BR33

ø 9,5 x H36,2 cm

SERIE DA APPOGGIO. TABLE TOP SERIES.

GEDY

Dori.

Realizzata in resina

Made of resin

Réalisée en résine

Hergestellt aus Harz

Realizada en resina

Изготовлено из бамбука



92
Turchese
Turquoise



DR98

ø 8,5 x H10,6 cm



DR11

L17,5 x P11,7 x H1,7 cm



DR80

L13,6 x P10,2 x H16,4 cm



DR33

ø 11,3 x P9,5 x H37,8 cm

SERIE DA APPOGGIO. TABLE TOP SERIES.

GEDY

Pyxis.

Realizzata in resine termoplastiche

Made of thermoplastic resins

Réalisée en résine thermoplastique

Hergestellt aus Kunststoff

Realizada en resinas termoplásticas

Изготовлено из термопластиченых смол



89

Bianco/blu
White/blue



PY10

ø 7,2 x H12 cm



PY11

L11 x P7,6 x H3,3 cm



PY80

ø 7 x H18,5 cm



PY33

ø 10,2 x H35 cm

SERIE DA APPOGGIO. TABLE TOP SERIES.

GEDY

100% MADE
in Italy



Seventy.

design Matteo Thun

Realizzata in resine termoplastiche

Made of thermoplastic resins

Réalisée en résine thermoplastique

Hergestellt aus Kunststoff

Realizada en resinas termoplásticas

Изготовлено из термопластиченых смол



08
Grigio
Grey



22
Bianco
White



27
Acquamarina
Aquamarine



52
Tortora
Turtledove grey



65
Blu petrolio
Petrol blue



66
Beige
Beige



79
Lilla
Lilac



86
Celeste
Sky blue



V7
Verde pistacchio
Pistachio green



design
R & S Gedy



6398

L6,5 x P6,5 x H12,2 cm



6311

L13,8 x P9 x H2,5 cm



6382

L6,5 x P7,1 x H16 cm



6334

L9 x P9 x H38,8 cm



6309

pag. 338



- 08
- 22
- 27
- 52
- 65
- 66
- 86

design
R & S Gedy

22

22



6308

L11,6 x P11,6 x H12,4 cm
1,2 LT



6300

L11,6 x P11,6 x H12,1 cm



6305

L5,5 x P5,5 x H11 cm



6306

L27 x P13,6 x H2,2 cm



6302

L20 x P12 x H6,4 cm

GEDY

Seventy.

22

66

100% MADE
in Italy



design Makio Hasuike

Organizer con specchio

Organizer with mirror
Organiseur avec miroir
Organizer mit Spiegel
Organizador con espejo
Органайзер с зеркалом



6301

L25 x P28 x H7,1 cm



Seventy.

Dispenser per dentifricio

Distributeur de dentifrice
Zahnpastaspender
Dispensador de pasta de dientes
Диспенсер для зубной пасты

22

Realizzato in resine termoplastiche

Made of thermoplastic resins
Réalisée en résine thermoplastique
Hergestellt aus Kunststoff
Realizada en resinas termoplásticas
Изготовлено из термопластиченых смол

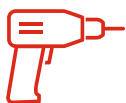

Con viti

With screws



Con biadesivo

With double sided

tape



6385

L7 x P7,1 x H13 cm

MADE
in Italy



NEW

design
R & S Gedy



Guarda il video x
scoprire di più sul
prodotto

Watch the video to find
out more about the
product

SERIE DA APPOGGIO. TABLE TOP SERIES.

GEDY

Seventy.

design Matteo Thun

NEW

100% MADE
in Italy



Save the
planet

EK^opla^o



Riciclabile
Recyclable



Riciclato
Recycled



14
Nero matt
Matt black

Materiale plastico riciclato

Recycled plastic

Plastique recyclé

Recyceltes Kunststoffmaterial

Material plástico reciclado

Переработанный пластик



6398

L6,5 x P6,5 x H12,2 cm



6312

L12,4 x P8 x H2,1 cm



6382

L6,5 x P7,1 x H16 cm



6333

L9 x P9 x H38,8 cm

design
R & S Gedy

SERIE DA APPOGGIO. TABLE TOP SERIES.

100% MADE
in Italy



GEDY

Glady.

Realizzata in resine termoplastiche

Made of thermoplastic resins

Réalisée en résine thermoplastique

Hergestellt aus Kunststoff

Realizada en resinas termoplásticas

Изготовлено из термопластиченых смол



00
Trasparente
Transparent



02
Bianco
White



04
Verde acido
Acid green



05
Blu
Blue



29
Moka
Moka



76
Fucsia
Fuchsia



79
Lilla
Lilac



85
Antracite
Anthracite



92
Turchese
Turquoise



GL98

ø 8,5 x H11 cm



GL11

L12,3 x P8 x H2,5 cm



GL80

ø 8,5 x H17 cm



GL33

ø 13,2 x H40,5 cm



GL00

L18,8 x P10,7 x H7,5 cm



GL09

pag. 337



SERIE DA APPOGGIO. TABLE TOP SERIES.

GEDY

100% MADE
in Italy



Sharon.

NEW

Realizzata in resine termoplastiche

Made of thermoplastic resins

Réalisée en résine thermoplastique

Hergestellt aus Kunststoff

Realizada en resinas termoplásticas

Изготовлено из термопластиченых смол



02
Bianco
White



08
Grigio
Grey



14
Nero matt
Matt black



SH98
ø 7 x H11,8 cm



SH11
L12,3 x P8,2 x H2,1 cm



SH80
ø 7 x H16,5 cm



SH33
ø 9 x H38,4 cm



SERIE DA APPOGGIO. TABLE TOP SERIES.

GEDY

100% MADE
in Italy



02
Bianco
White

Moby.

Realizzata in resine termoplastiche

Made of thermoplastic resins

Réalisée en résine thermoplastique

Hergestellt aus Kunststoff

Realizada en resinas termoplásticas

Изготовлено из термопластиченых смол



3198

L8,7 x P8,3 x H11,5 cm



3111

L15 x P12 x H5,5 cm



3182

L8,7 x P8,3 x H16,5 cm



3133

L11 x P10,9 x H37,8 cm

GEDY

Spot.

Portasapone in PVC

Soap holder made of PVC

Porte savon en PVC

Seifenschale aus PVC

Jabonera en PVC

Мыльница из ПВХ

Colori trasparenti - Transparent colours



P1
Azzurro
Light blue



P2
Trasparente
Transparent



P8
Verde acido
Acid green

Colori pieni - Solid colours



02
Bianco
White



08
Grigio
Grey



66
Tortora chiaro
Light
turtledove grey

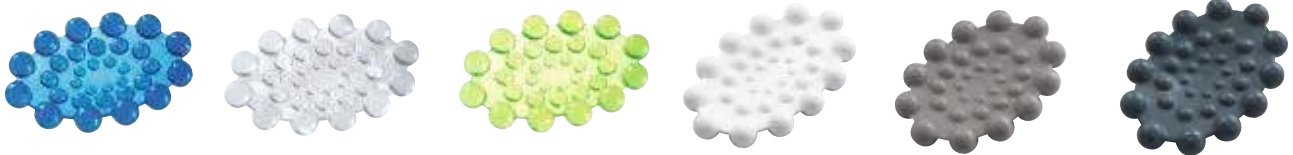

2004

L12,7 x P8,7 x H1,6 cm

GEDY

Silverino.

NEW

Disco antibatterico - resine termoplastiche e argento

Antibacterial disc - silver and thermoplastic resins

Disque antibactérien - argent et résine thermoplastique

Antibakterielle Scheibe - Silber und Kunststoff

Disco antibacteriano - plata y resinas termoplásticas

Антибактериальный диск

серебро и термопластиченых смол



con Antibatterico
with Antibacterial



2020

ø 4 x H0,4 cm



Guarda il video x
scoprire di più sul
prodotto

Watch the video to find
out more about the
product

100% MADE
in Italy



00





**SPECCHI E
ILLUMINAZIONE**
Mirrors and lighting





Specchi con luci

Mirrors with lights - Miroirs avec éclairage - Spiegel mit Beleuchtung
Espejos con luces - Зеркала со светильником

Paul.

TOP DESIGN

**Specchio con luci a led
e sistema anti-appannamento**

Mirror with LED lights and anti-fog system

Miroir avec lumières LED et système anti-buée

Spiegel mit LED-Leuchten und Beschlagschutzsystem

Espejo con luces led y sistema antiempañamiento

Зеркало со светодиодной подсветкой

и системой антизапотевания



**Anti
appannamento**

Anti fog



**Reversibile
Reversible**



**Digital
touch**



**Garanzia LED
LED Warranty**



**ECO
Friendly**



**Senza piombo
Lead Free**



**Luce ad alta
precisione
High precision
light**

**MADE
in
Spain**

CE
IP 44 - RoHS
220-240 V
50-60 Hz
anti fog 22W
CLASS EXEMPT
GROUP EN 62471
CRI>91



Cornice in alluminio - Frame in aluminium - Cadre en aluminium - Aluminiumrahmen - Marco de aluminio - Алюминиевая рама

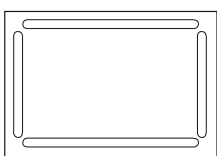

3204

L140 x P2,6 x H80 cm
42W - 1140 lumen - 5700°K

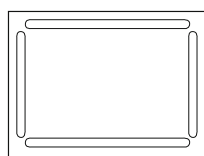

3203

L120 x P2,6 x H80 cm
40W - 900 lumen - 5700°K

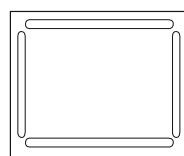

3202

L100 x P2,6 x H80 cm
40W - 850 lumen - 5700°K

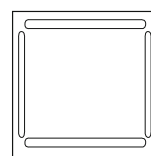

3201

L80 x P2,6 x H80 cm
30W - 880 lumen - 5700°K

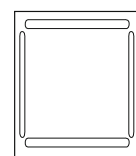

3200

L60 x P2,6 x H80 cm
30W - 740 lumen - 5700°K



**38
Spazzolato
Brushed**

Specchi con luci - Mirrors with lights.

Paul.

TOP DESIGN

Specchio con luci a led

Mirror with LED lights

Miroir avec lumières LED

Spiegel mit LED-Leuchten

Espejo con luces led

Зеркало со светодиодной подсветкой



Reversibile
Reversible



Digital
touch



Garanzia LED
LED Warranty



ECO
Friendly



Senza piombo
Lead Free



Luce ad alta
precisione
High precision
light

MADE
in
Spain

CE
IP 44 - RoHS
220-240 V
50-60 Hz

SPECCHIE
ILLUMINAZIONE
Mirrors and lighting



Cornice in alluminio - Frame in aluminium - Cadre en aluminium - Aluminiumrahmen - Marco de aluminio - Аллюминиевая рама

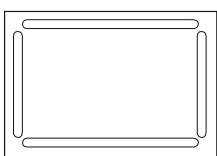

3004

L140 x P2,6 x H80 cm
42W - 1140 lumen - 5700°K

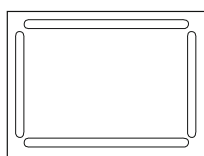

3003

L120 x P2,6 x H80 cm
40W - 900 lumen - 5700°K

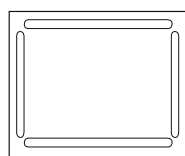

3002

L100 x P2,6 x H80 cm
40W - 850 lumen - 5700°K

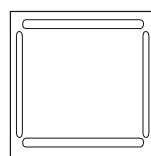

3001

L80 x P2,6 x H80 cm
30W - 880 lumen - 5700°K

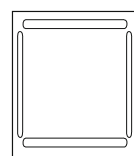

3000

L60 x P2,6 x H80 cm
30W - 740 lumen - 5700°K



14
Nero matt
Matt black



38
Spazzolato
Brushed

Salvador.

TOP DESIGN

Specchio filo lucido con luci a led e sistema anti-appannamento

Polished wire mirror with LED lights and anti-fog system

Miroir bord brillant avec lumières LED et système anti-buée

Spiegel mit polierten Kanten mit LED-Leuchten

und Beschlagschutzsystem

Espejo canto pulido \varnothing 90 con luces led y sistema antiempañamiento

Зеркало с полированной кромкой, светодиодной подсветкой

и системой антизапотевания



Anti
appannamento

Anti fog



Garanzia LED
LED Warranty



ECO
Friendly



Senza piombo
Lead Free

MADE
in
Spain

CE
IP 44 - RoHS
220-240 V
50-60 Hz
anti fog 22W
CLASS EXEMPT
GROUP EN 62471

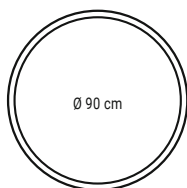

\varnothing 90 cm

3055

\varnothing 90 x P2,6 cm

30W - 1770 lumen - 5700°K - CRI>90

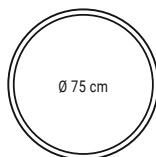

\varnothing 75 cm

3054

\varnothing 75 x P2,6 cm

20W - 1140 lumen - 5700°K - CRI>83

Specchi con luci - Mirrors with lights.

Leonard.

TOP DESIGN

Specchio con luci a led

Mirror with LED lights

Miroir avec lumières LED

Spiegel mit LED-Leuchten

Espejo con luces led

Зеркало со светодиодной подсветкой



Garanzia LED
LED Warranty



ECO
Friendly

MADE
in
Spain



Senza piombo
Lead Free



Luce ad alta
precisione
High precision
light

CE
IP 44 - RoHS
220 - 240 V
50-60 Hz
CLASS EXEMPT
GROUP EN 62471
CRI>90



Cornice in alluminio - Frame in aluminium - Cadre en aluminium - Aluminiumrahmen - Marco de aluminio - Алюминиевая рама

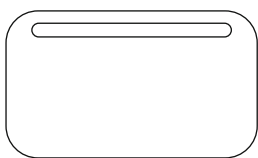

3053

L120 x P3 x H70 cm
14W - 1657 lumen - 4000°K

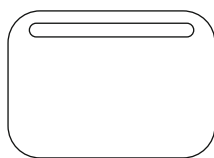

3052

L100 x P3 x H70 cm
12W - 1280 lumen - 4000°K

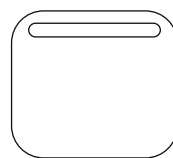

3051

L80 x P3 x H70 cm
10W - 1200 lumen - 4000°K

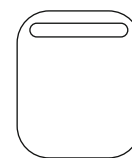

3050

L60 x P3 x H70 cm
7W - 846 lumen - 4000°K



14
Nero matt
Matt black

SPECCHI E ILLUMINAZIONE . MIRRORS AND LIGHTING .

Amedeo.

TOP DESIGN

Specchio filo lucido ovale con luci a led

Oval polished edge mirror with LED lights

Miroir bord poli ovale avec lumières LED

Ovaler Spiegel mit polierten Kanten und LED-Leuchten

Espejo canto pulido ovalado con luces led

Овальное зеркало с полированной кромкой

и светодиодной подсветкой



Reversibile
Reversible



Garanzia LED
LED Warranty

MADE
in
Spain



ECO
Friendly



Senza piombo
Lead Free

CE
IP 44 - RoHS
220-240 V
50-60 Hz
5700°K CLASS
EXEMPT GROUP
EN 62471

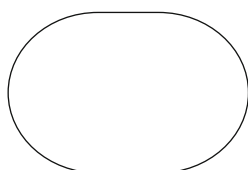

3056

L85 x P3 x H60 cm

30W - 898 lumen - 5700°K - CRI>90



3057

L90 x P3 x H45 cm

20W - 880 lumen - 5700°K - CRI>85

Specchi con luci - Mirrors with lights.

Alfred.

TOP DESIGN

Specchio filo lucido con luci a led

Polished edge mirror with LED lights

Miroir bord poli avec lumières LED

Spiegel mit polierten Kanten und LED-Leuchten

Espejo canto pulido con luces led

Зеркало с полированной кромкой и
светодиодной подсветкой



Reversibile
Reversible



Digital
touch

100% MADE
in Italy



Garanzia LED
LED Warranty

CE
IP 44 - RoHS
220 - 240 V
50-60 Hz
EXEMPT GROUP
EN 62471

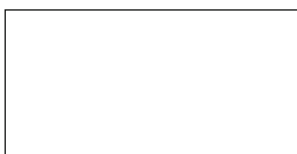

3157

L140 x P2,6 x H70 cm

36W - 1100 lumen - 4000°K - CRI>91

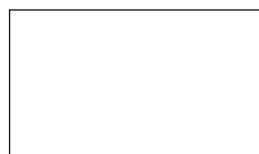

3156

L120 x P2,6 x H70 cm

32W - 960 lumen - 4000°K - CRI>91



3155

L100 x P2,6 x H70 cm

29W - 870 lumen - 4000°K - CRI>90



3154

L80 x P2,6 x H60 cm

24W - 720 lumen - 4000°K - CRI>91

Pierre.

TOP DESIGN

Specchio filo lucido con luci a led e bordo sabbiato

Polished edge mirror with LED lights and sandblasted border

Miroir bord poli avec lumières LED et bord sablé

Spiegel mit polierten Kanten und LED-Leuchten und sandgestrahltem Rand

Espejo canto pulido con luces led y marco arenado

Зеркало с полированной кромкой, светодиодной подсветкой и окантовкой, подвергнутой пескоструйной обработке



Reversibile
Reversible



Digital
touch

100% MADE
in Italy



Garanzia LED
LED Warranty

CE
IP 44 - RoHS
220-240 V
50-60 Hz
EXEMPT GROUP
EN 62471



3253

L140 x P2,6 x H70 cm

34W - 1940 lumen - 4000°K - CRI>91

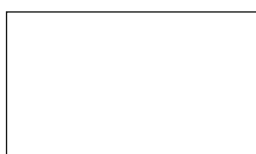

3252

L120 x P2,6 x H70 cm

31W - 1770 lumen - 4000°K - CRI>91



3251

L100 x P2,6 x H70 cm

27W - 1540 lumen - 4000°K - CRI>90

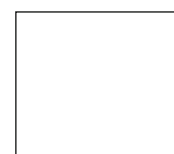

3250

L80 x P2,6 x H60 cm

22W - 1250 lumen - 4000°K - CRI>91

Specchi con luci - Mirrors with lights.

Edgar.

TOP DESIGN

Specchio filo lucido con luci a led

Polished edge mirror with LED lights

Miroir bord poli avec lumières LED

Spiegel mit polierten Kanten und LED-Leuchten

Espejo canto pulido con luces led

Зеркало с полированной кромкой и

светодиодной подсветкой



Digital
touch



Garanzia LED
LED Warranty

100% MADE
in Italy



CE
IP 44 - RoHS
220 - 240 V
50-60 Hz
EXEMPT GROUP
EN 62471

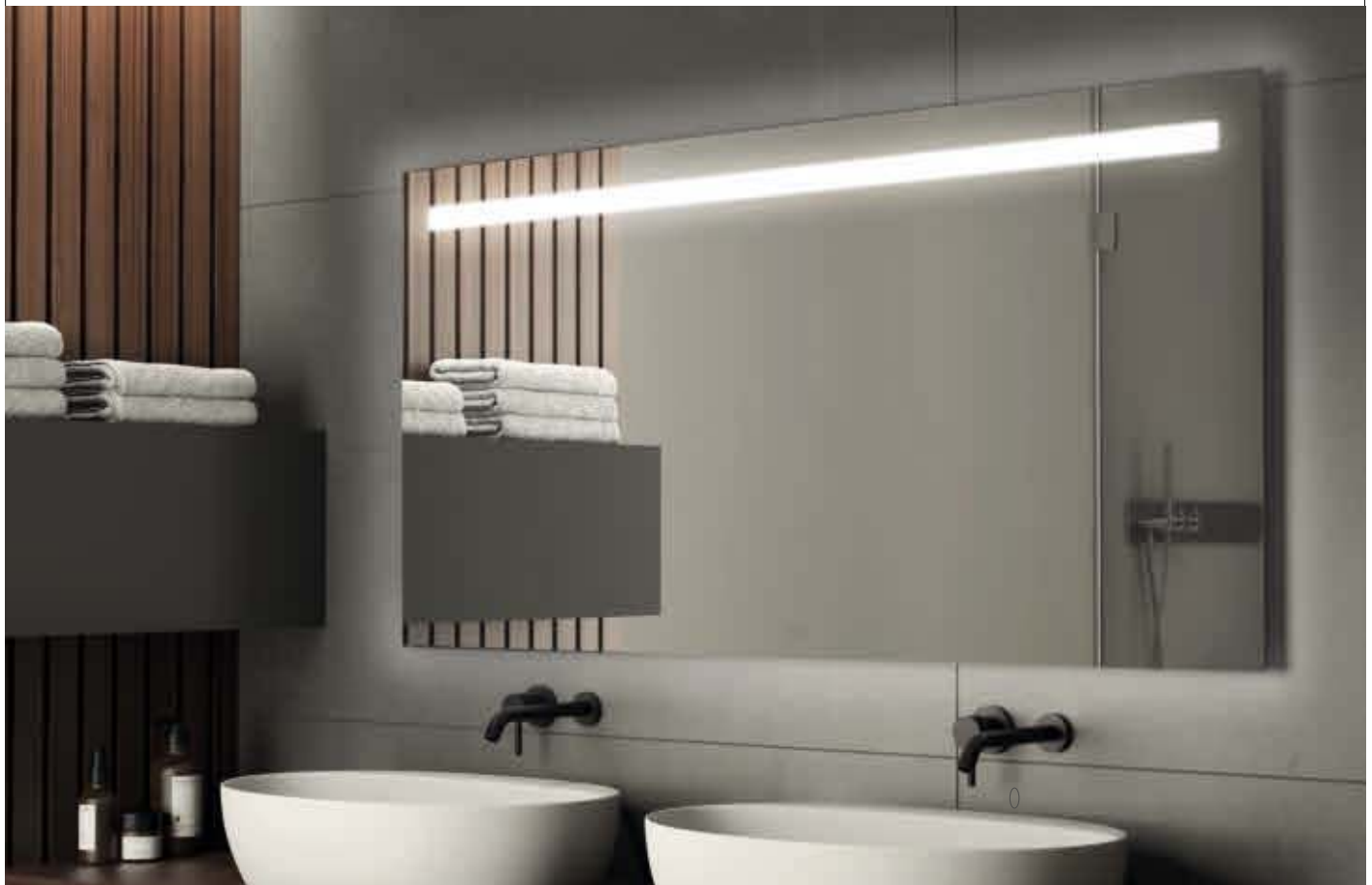

3256

L140 x P2,6 x H70 cm

48W - 4770 lumen - 4000°K - CRI>91



3255

L120 x P2,6 x H70 cm

42W - 4230 lumen - 4000°K - CRI>91



3254

L100 x P2,6 x H70 cm

37W - 3690 lumen - 4000°K - CRI>90

SPECCHIE
ILLUMINAZIONE
Mirrors and lighting

Jeff.

TOP DESIGN

Specchio con luci a led e bordo sabbiato

Mirror with LED lights and sandblasted border

Miroir avec lumières LED et bord sablé

Spiegel mit LED-Leuchten und sandgestrahltem Rand

Espejo con luces led y marco arenado

Зеркало со светодиодной подсветкой и окантовкой, подвергнутой пескоструйной обработке



Reversibile
Reversible



Digital
touch

100% MADE
in **Italy**



Garanzia LED
LED Warranty



Luce ad alta
precisione
High precision
light

CE
IP 44 - RoHS
220-240 V
50-60 Hz
EXEMPT GROUP
EN 62471



Cornice in PVC - Frame of PVC - Cadre en PVC - PVC-Rahmen - Marco de PVC - Рама из ПВХ

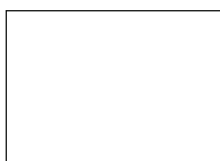

3304

L110 x P2,6 x H80 cm

20W - 1980 lumen - 4000°K - CRI>91



3303

L100 x P2,6 x H70 cm

18W - 1800 lumen - 4000°K - CRI>91



3302

L80 x P2,6 x H60 cm

11W - 1080 lumen - 4000°K - CRI>90



14
Nero matt
Matt black

Specchi con luci - Mirrors with lights.

George.

TOP DESIGN

Specchio filo lucido con luci a led

Polished edge mirror with LED lights

Miroir bord poli avec lumières LED

Spiegel mit polierten Kanten und LED-Leuchten

Espejo canto pulido con luces led

Зеркало с полированной кромкой и

светодиодной подсветкой



Digital
touch



Garanzia LED
LED Warranty

100% MADE
in Italy



CE
IP 44 - RoHS
220 - 240 V
50-60 Hz
EXEMPT GROUP
EN 62471

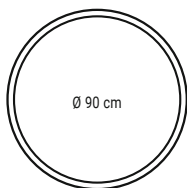

Ø 90 cm

3307

Ø 90 x P3 cm

24W - 720 lumen - 4000°K - CRI>91

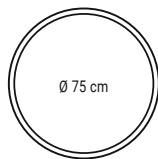

Ø 75 cm

3306

Ø 75 x P3 cm

20W - 600 lumen - 4000°K - CRI>91

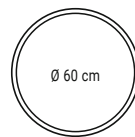

Ø 60 cm

3305

Ø 60 x P3 cm

16W - 480 lumen - 4000°K - CRI>90

Franz.

TOP DESIGN

Specchio ovale con luci a led e bordo sabbato

Oval mirror with LED lights and sandblasted border

Miroir ovale avec lumières LED et bord sablé

Ovaler Spiegel mit LED-Leuchten und sandgestrahltem Rand

Espejo ovalado con luces led y marco arenado

Овальное зеркало со светодиодной подсветкой и окантовкой, подвергнутой пескоструйной обработке



Reversibile
Reversible



Digital
touch



Garanzia LED
LED Warranty



Luce ad alta
precisione

High precision
light

100% MADE
in Italy



IP 44 - RoHS
220-240 V
50-60 Hz
EXEMPT GROUP
EN 62471
CRI>90



Cornice in metallo - Frame in metal - Cadre en métal - Metall-Rahmen - Marco de metal - Металл рама

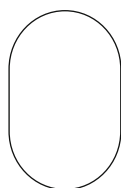

3058

L50 x P4 x H90 cm
20W - 1980 lumen - 4000°K



14
Nero matt
Matt black

Marc.

TOP DESIGN

Specchio con luci a led e bordo sabbato

Mirror with LED lights and sandblasted border

Miroir avec lumières LED et bord sablé

Spiegel mit LED-Leuchten und sandgestrahltem Rand

Espejo con luces led y marco arenado

Зеркало со светодиодной подсветкой и окантовкой, подвергнутой пескоструйной обработке



Digital touch

100% MADE in Italy



Garanzia LED
LED Warranty



Luce ad alta precisione

High precision light

CE
IP 44 - RoHS
220 - 240 V
50-60 Hz
EXEMPT GROUP
EN 62471



Cornice in metallo - Frame in metal - Cadre en métal - Metall-Rahmen - Marco de metal - Metall рама

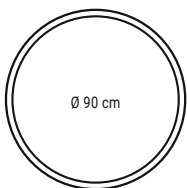

Ø 90 cm

3258

Ø 90 x P4 cm

23W - 2340 lumen - 4000°K - CRI>91

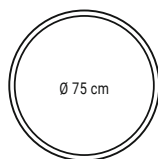

Ø 75 cm

3257

Ø 75 x P4 cm

19W - 1935 lumen - 4000°K - CRI>90



14
Nero matt
Matt black

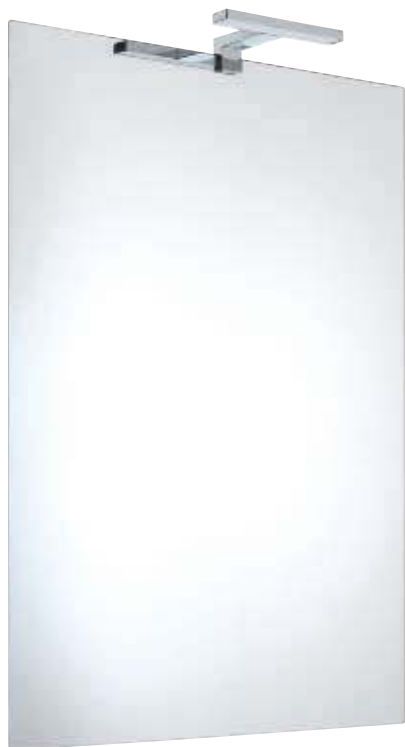

2556-01 William.

GEDY

Specchio filo lucido con luce led

Polished edge mirror with led light

Miroir bord poli avec lumière led

Spiegel mit polierten Kanten mit LED-Leuchten

Espejo canto pulido con luce led

Зеркало с полированными краями со
светодиодной подсветкой

L60 x P13,5 x H84,6 cm

NEW

MADE
in **Italy**



Reversible
Reversible

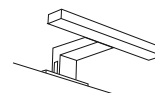

CE
IP 44 - 230V-50Hz
LED 3,62W - 6000K*
220 lumen - CRI 90



8001 Junior.

design Gianpietro Tonetti

GEDY

Specchio

Mirror - Miroir - Spiegel - Espejo - Зеркало

Cornice in resina termoplastica

Frame of thermoplastic resins

Cadre en résine thermoplastique

Kunststoff-Rahmen

Marco de resinas termoplásticas

Рама из термопластичных смол



02
Bianco
White

L55 x P5,5 x H60 cm

CE
IP 20 - W25 - E14
NORMA EN 605998 - 1/2 - 1 & 2006/95/CE

Specchi senza luci

Mirrors without lights - Miroirs sans éclairage
Spiegel ohne Beleuchtung - Espejos sin luces - Зеркала без подсветки

Henri.

TOP DESIGN

Specchio

Mirror - Miroir

Spiegel - Espejo

Зеркало



Reversibile
Reversible

100% MADE
in Italy



Cornice in PVC - Frame of PVC - Cadre en PVC - PVC-Rahmen - Marco de PVC - Рама из ПВХ



3153

L100 x P2,6 x H70 cm



3152

L90 x P2,6 x H65 cm



3151

L80 x P2,6 x H60 cm



3150

L70 x P2,6 x H50 cm



38
Spazzolato
Brushed



2590 Jackson.

100% MADE
in Italy



GEDY

Specchio infrangibile

Mirror with shatterproof surface

Mirror infrangible

Bruchsicherer Spiegel

Espejo irrompible

Зеркало с полированными



Reversible
Reversible

L60 x P2,5 x H70 cm

Acciaio inox - stainless steel - acier inox
Edelstahl - нержавеющей сталь



13
Super
Mirror

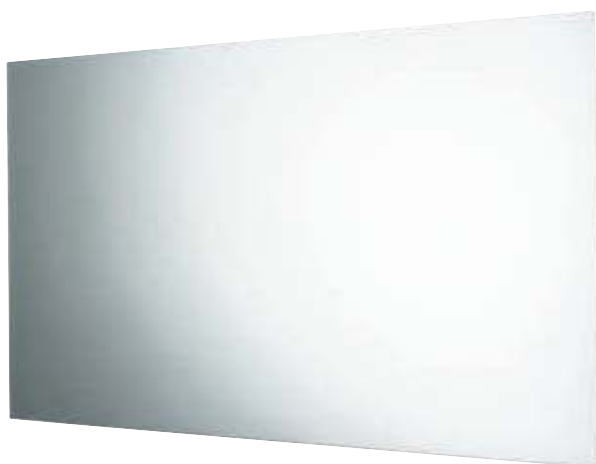

2557 William.

100% MADE
in Italy



GEDY

Specchio filo lucido

Polished edge mirror

Miroir bord poli

Spiegel mit polierten Kante

Espejo canto pulido

Зеркало с полированными краями



Reversible
Reversible

L100 x P2 x H70 cm

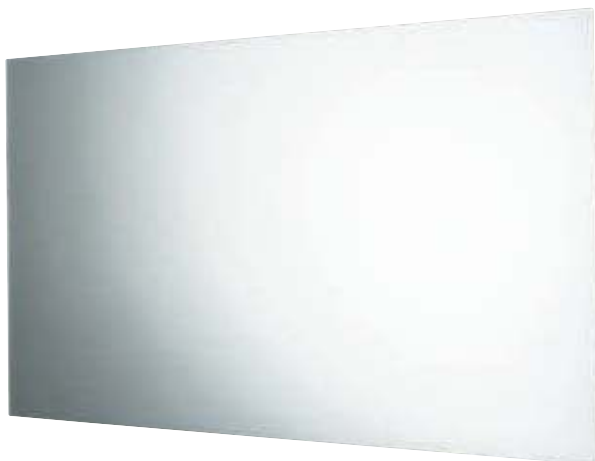

2551 William.

100% MADE
in **Italy**



GEDY

Specchio filo lucido

Polished edge mirror

Mirror bord poli

Spiegel mit polierten Kante

Espejo canto pulido

Зеркало с полированными краями



Reversibile

Reversible

L100 x P2 x H60 cm



2556 William.

100% MADE
in **Italy**



GEDY

Specchio filo lucido

Polished edge mirror

Miroir bord poli

Spiegel mit polierten Kante

Espejo canto pulido

Зеркало с полированными краями



Reversibile

Reversible

L60 x P2 x H80 cm



2540. 2550 William.

100% MADE
in Italy



GEDY

Specchio filo lucido

Polished edge mirror

Mirror bord poli

Spiegel mit polierten Kante

Espejo canto pulido

Изготовлено из овлонолено



Reversibile

Reversible

2540

L50 x P2 x H80 cm

2550

L60 x P2 x H70 cm



2545. 2560 William.

100% MADE
in Italy



GEDY

Specchio bisellato

Bevelled mirror

Miroir biseauté

Spiegel mit Facettenschliff

Espejo biselado

Зеркало со скшенными краями



Reversibile

Reversible

2545

L50 x P2 x H80 cm

2560

L60 x P2 x H70 cm



8400 Dakota.

design Carlo Vietri

GEDY

Specchio filo lucido

Polished edge mirror

Mirror bord poli

Spiegel mit polierten Kante

Espejo canto pulido

Изготовлено из овленолено

L50 x P2 x H65 cm

100% MADE
in Italy



Reversible
Reversible



2554 William.

100% MADE
in Italy



GEDY

Specchio filo lucido

Polished edge mirror

Miroir bord poli

Spiegel mit polierten Kante

Espejo canto pulido

Зеркало с полированными краями

∅ 80 x P2 cm

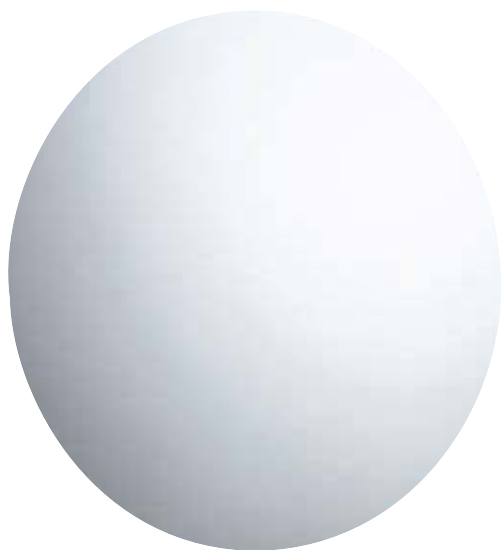

2520 William.

100% MADE
in Italy



GEDY

Specchio filo lucido

Polished edge mirror

Mirror bord poli

Spiegel mit polierten Kante

Espejo canto pulido

Изготовлено из овленолено

∅ 65 x P2 cm



2575 William.

100% MADE
in Italy

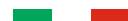

GEDY

Specchio filo lucido ovale

Polished edge ovale mirror

Miroir ovale bord poli

Ovaleer Spiegel mit polierten Kante

Espejo ovaleado canto pulido

Зеркало овальное

с полированными краями

L75 x P2 x H55 cm



Reversible
Reversible



2604.

100% MADE
in Italy

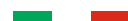

GEDY

Specchio

Mirror - Miroir - Spiegel - Espejo - Зеркало

Cornice in resina termoplastica

Frame of thermoplastic resins

Cadre en résine thermoplastique

Kunststoff-Rahmen

Marco de resinas termoplásticas

Рама из термопластичных смол

L60 x P6 x H70 cm



02
Bianco
White

6000.

GEDY

100% MADE
in **Italy**



Specchio

Mirror

Miroir

Spiegel

Espejo

Зеркало



Cornice in resine termoplastiche - Frame of thermoplastic resins - Cadre en résine thermoplastique - Kunststoff-Rahmen
Marco de resinas termoplásticas - Рама из термопластиченых смол

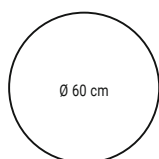

6000

Ø 60 x P3 cm



02
Bianco
White



14
Nero
Black

6004.

GEDY

L55 x P3 x H55 cm



Specchio

Mirror - Miroir - Spiegel - Espejo - Зеркало

Cornice in resina termoplastica

Frame of thermoplastic resins

Cadre en résine thermoplastique

Kunststoff-Rahmen

Marco de resinas termoplàsticas

Рама из термопластичных смол

100% MADE
in **Italy**



02

Bianco
White

2901.

GEDY

L45 x P14,7 x H60 cm



Specchio con mensola

Mirror with shelf - Miroir avec étagère

Spiegel mit Ablage - Espejo con estante

Зеркало со полочка

Cornice in resina termoplastica

Frame of thermoplastic resins

Cadre en résine thermoplastique

Kunststoff-Rahmen

Marco de resinas termoplàsticas

Рама из термопластичных смол

100% MADE
in **Italy**



02

Bianco
White

2900.

GEDY

L45 x P4 x H45 cm



Specchio

Mirror - Miroir - Spiegel - Espejo - Зеркало

Cornice in resina termoplastica

Frame of thermoplastic resins

Cadre en résine thermoplastique

Kunststoff-Rahmen

Marco de resinas termoplàsticas

Рама из термопластичных смол

100% MADE
in **Italy**



02

Bianco
White

8000 Junior.

GEDY

L55 x P3,5 x H60 cm



design **Gianpietro Tonetti**

100% MADE
in **Italy**



Specchio

Mirror - Miroir - Spiegel - Espejo - Зеркало

Cornice in resina termoplastica

Frame of thermoplastic resins

Cadre en résine thermoplastique

Kunststoff-Rahmen

Marco de resinas termoplàsticas

Рама из термопластичных смол



02

Bianco
White

Specchi contenitori e armadietti

Mirror cabinets and cabinets - Meubles à miroirs et armoires
Behälterspiegel und kleine Schränken - Espejos contenedores y armarios
Шкаф изготовлено из нержавеющей

2806-01 Banjo.

NEW

GEDY

L51 x P23 x H64,6 cm



13

Lucido/cromato
Polished/chromed

MADE
in Italy

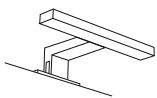

IP 44 - 230V-50Hz
LED 3,62W - 6000K*
220 lumen - CRI 90



Con anta a specchio reversibile e 1 ripiano e con luce led

With reversible mirror door and 1 shelf and with led light

Avec porte à miroir réversible et 1 étagère et avec lumière led

Mit reversibler Spiegeltür und 1 Ablage und mit LED-Leuchten

Con puerta de espejo reversible y 1 repisa y con luce led

С реверсивной зеркальной дверцей и 1 полочка и со

светодиодной подсветкой

Acciaio inox, vetro e resine termoplastiche

Stainless steel, glass and thermoplastic resins

Acier inoxydable, verre et résine thermoplastique

Edelstahl, Glas und Kunststoff

Acero inox, cristal y resinas termoplásticas

Ержавеющая сталь, стекла и термопластичных смол

2806 Banjo.

GEDY

L51 x P11,5 x H60 cm



13

Lucido
Polished

100% MADE
in Italy

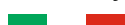

Con anta a specchio reversibile e 1 ripiano

With reversible mirror door and 1 shelf

Avec porte à miroir réversible et 1 étagère

Mit reversibler Spiegeltür und 1 Ablage

Con puerta de espejo reversible y 1 repisa

С реверсивной зеркальной дверцей и 1 полочка

Acciaio inox e vetro

Stainless steel and glass - Acier inoxydable et verre

Edelstahl und Glas - Acero inox y cristal

Нержавеющей стали и стекла

K007-01 Kora.

NEW

GEDY

L46 x P23,5 x H70,6 cm



13

Lucido/cromato
Polished/chromed



IP 44 - 230V-50Hz
LED 3,62W - 6000K*
220 lumen - CRI 90

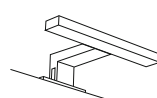

Armadietto reversibile con antina

a specchio scorrevole, 3 ripiani e con luce led

AISI
304

Reversible cabinet with sliding mirror door, 3 shelves and led light

Armoire reversible avec porte à miroir coulissante, 3 tablettes et lumière led

Schrankchen reversibel mit Spiegel-Schiebetür, 3 Einlegeboden

und LED-Leuchten

Armario reversible con puerta de espejo corredera, 3 estantes y luce led

Шкафчик с зеркальной раздвижной дверцей нержавеющей,

3 полки и со светодиодной подсветкой

Acciaio inox AISI 304, vetro e resine termoplastiche

AISI 304 stainless steel, glass and thermoplastic resins

Acier inoxydable AISI 304, verre et résine thermoplastique

Edelstahl AISI 304, Glas und Kunststoff

Acero inox AISI 304, cristal y resinas termoplásticas

Ержавеющая сталь AISI 304, стекла и термопластичных смол

K007 Kora.

GEDY

L46 x P12 x H66 cm



Armadietto reversibile con antina

a specchio scorrevole

Reversible cabinet with sliding mirror door

Armoire reversible avec porte à miroir coulissante

Schränkchen reversibel mit Spiegel-Schiebetür

Armario reversible con puerta de espejo corredera

Шкафчик с зеркальной раздвижной дверцей

нержавеющая

AISI
304

13
Lucido
Polished

Acciaio inox AISI 304 e vetro

AISI 304 stainless steel and glass

Acier inoxydable AISI 30 et verre

Edelstahl AISI 304 und Glas

Acero inox AISI 304 y cristal

Ержавеющая сталь AISI 304 и стекла

J007 Joker.

GEDY

L30 x P12 x H50 cm



Armadietti con anta in vetro, serratura di sicurezza e 1 ripiano

Cabinets with glass door, safety lock and 1 shelf

Armoires avec porte vitrée, serrure de sécurité

Schränkchen mit Glastür, Sicherheitsschloss

und 1 Ablage

Armarios con puerta de cristal, cerradura

de seguridad y 1 repisa

Шкафчик со стеклянной створкой, замком и 1 полочка

13
Lucido
Polished

Acciaio inox e vetro

Stainless steel and glass - Acier inoxydable et verre

Edelstahl und Glas - Acero inox y cristal

Ержавеющая сталь и стекла

J035 Joker.

GEDY

L30 x P12 x H30 cm



Armadietti con anta in vetro, serratura

di sicurezza e 1 ripiano

Cabinets with glass door, safety lock and 1 shelf

Armoires avec porte vitrée, serrure de sécurité

Schränkchen mit Glastür, Sicherheitsschloss

und 1 Ablage

Armarios con puerta de cristal, cerradura

de seguridad y 1 repisa

Шкафчик со стеклянной створкой, замком и 1 полочка

13
Lucido
Polished

Acciaio inox e vetro

Stainless steel and glass - Acier inoxydable et verre

Edelstahl und Glas - Acero inox y cristal

Ержавеющая сталь и стекла

8047 Princess.

GEDY

L58,5 x P14 x H38 cm

Specchio contenitore

Vanity unit

Meuble à miroir

Spiegelschrank

Espejo contenedor

Зеркало-шкаф



con 3 ante a specchio e 2 ripiani

with 3 mirror doors and 2 shelves

avec 3 portes à miroir et 2 tablettes

mit 3 Spiegeltüren und 2 Einlegeböden

con 3 puertas de espejo y 2 estantes

С 3 зеркальными дверцами и 2 полки

Vetro e resine termoplastiche

Glass and thermoplastic resins

Verre et résine thermoplastique

Glas und Kunststoff

Cristal y resinas termoplásticas

Стекла и термопластичных смол

100% MADE
in Italy



02

Bianco
White



8006.8007 Lilliput.

GEDY

Armadietto

con ripiani posizionabili

Cabinet with adjustable shelves

Armoire avec tablettes réglables

Kleiner Schrank mit positionierbaren

Einlegeböden

Armario con estantes regulables

Шкафчик с съемными полками



L30 x P14,3 x H45 cm

design Olaf Von Bohr

8006

Senza specchio

Without mirror - Sans miroir - Ohne Spiegel

Sin espejo - Без зеркальной створки

Resine termoplastiche

Thermoplastic resins - Résine thermoplastique

Kunststoff - Resinas termoplásticas - Термопластичных смол



02

Bianco
White

8007

Con anta a specchio

With mirror door - Avec porte à miroir - Mit Spiegeltür

Con puerta de espejo - С зеркальной дверцей

Vetro e resine termoplastiche

Glass and thermoplastic resins - Verre et résine thermoplastique

Glas und Kunststoff - Cristal y resinas termoplásticas

стекла и термопластичных смол

8035 Jolly.

GEDY

L25 x P12,5 x H39,5 cm



Armadietto farmacia con chiave e 1 ripiano

Medicine cabinet with key and 1 shelf

Armoire à pharmacie avec clef et 1 tablette

Arzneischrank mit Schlüssel und 1 Einlegeboden

Botiquín con llave y estante

Шкафчик-аптечка с ключом и 1 полкой

100% MADE
in Italy



02

Bianco
White

Resine termoplastiche

Thermoplastic resins - Résine thermoplastique

Kunststoff - Resinas termoplásticas

Термопластичных смол

Illuminazione

Lighting - Luminaires - Licht im Bad
Iluminación - Подсветка

D040 Ibiza.



13
Cromato
Chromed

TOP DESIGN



Lampada a Led con attacco universale a pinza per specchi senza cornice

LED light with universal socket and clip for mirror without frame

Lampe LED avec fixation universelle à pince pour miroirs sans cadre

Led-Leuchte mit universeller Klemmbefestigung für Spiegel ohne Rahmen

Lámpara de led con fijación universal de pinza para espejos sin marco

Светодиодная лампа с универсальным креплением на зеркала без рамы

Cromall® e resine termoplastiche

Cromall® and thermoplastic resins

Cromall® et résine thermoplastique

Cromall® und Kunststoff

Cromall® y resinas termoplásticas

Сромалл® и термопластичных смол

L10 xP16,8 x H3,4 cm



CLASS EXEMPT GROUP

secondo norma EN 62471 - according with EN 62471

IP 44 - 230V-50Hz
LED 4.4W - 420 Lumen
3000°K - CRI 80



D040-01 Ibiza.



13
Cromato
Chromed

TOP DESIGN

Lampada a Led con telaio di fissaggio per specchi con cornice

LED lamp with fastening frame for framed mirrors

Lampe à leds avec cadre de fixation disposé pour les miroirs avec cadre

LED-Lampe mit Befestigungsrahmen für Spiegel mit Rahmen

Lámpara de led con bastidor de fijación predispuesto para espejos con marco

Светодиодная лампа с креплением на зеркала с рамой

Cromall® e resine termoplastiche

Cromall® and thermoplastic resins

Cromall® et résine thermoplastique

Cromall® und Kunststoff

Cromall® y resinas termoplásticas

Сромалл® и термопластичных смол

L10 x P15,5 x H4,2 cm



CLASS EXEMPT GROUP

secondo norma EN 62471 - according with EN 62471

IP 44 - 230V-50Hz
LED 4.4W - 420 Lumen
3000°K - CRI 80



Cromall® e resine termoplastiche

Cromall® and thermoplastic resins

Cromall® et résine thermoplastique

Cromall® und Kunststoff

Cromall® y resinas termoplásticas

Сромалл® и термопластичных смол

D041 Maiorca.



13
Cromato
Chromed

TOP DESIGN

Lampada a Led con attacco universale a pinza per specchi senza cornice

LED light with universal socket and clip for mirror without frame

Lampe LED avec fixation universelle à pince pour miroirs sans cadre

LED-Leuchte mit universeller Klemmbefestigung für Spiegel ohne Rahmen

Lámpara de led con fijación universal de pinza para espejos sin marco

Светодиодная лампа с универсальным креплением

на зеркала без рамы

L8,1 x P14,8 x H3,2 cm

CE

CLASS EXEMPT GROUP

secondo norma EN 62471 - according with EN 62471

IP 44 - 230V-50Hz
LED 4.4W - 450 Lumen
6000°K - CRI 90



Cromall® e resine termoplastiche

Cromall® and thermoplastic resins

Cromall® et résine thermoplastique

Cromall® und Kunststoff

Cromall® y resinas termoplásticas

Сромалл® и термопластичных смол

D041-01 Maiorca.



13
Cromato
Chromed

TOP DESIGN

Lampada a Led con telaio di fissaggio per specchi con cornice

LED lamp with fastening frame for framed mirrors

Lampe à leds avec cadre de fixation disposé pour les miroirs avec cadre

LED-Lampe mit Befestigungsrahmen für Spiegel mit Rahmen

Lámpara de led con bastidor de fijación predispuesto

para espejos con marco

Светодиодная лампа с креплением на зеркала с рамой

L8,1 x P13,5 x H4,2 cm

CE

CLASS EXEMPT GROUP

secondo norma EN 62471 - according with EN 62471

IP 44 - 230V-50Hz
LED 4.4W - 450 Lumen
6000°K - CRI 90



Resine termoplastiche

Thermoplastic resins
 Résine thermoplastique
 Kunststoff
 Resinas termoplásticas
 Термопластичных смол

D043 Kos.

TOP DESIGN



13
Cromato
 Chromed

Lampada a Led con attacco universale per specchi con e senza cornice

LED lamp with universal attachment for mirrors with or without frame

Lampe LED universelle pour miroirs avec ou sans cadre

LED-Lampe mit Universalbefestigung für Spiegel mit und ohne Rahmen

Lámpara de led con fijación universal para espejos con y sin marco

Силиконовые форсунки и микроотверстия, которые обеспечивают экономию воды и усиливают напор струи

D043-30

L30 x P10,3 x H3,5 cm
 LED 7W - 680 lumen

D043-50

L50 x P10,3 x H3,5 cm
 LED 9W - 660 lumen

CLASS EXEMPT GROUP
 secondo norma EN 62471 - according with EN 62471

CE
 IP 44 - RoHS - 220-240V
 50-60 Hz - 6000°K - CRI >90



Resine termoplastiche

Thermoplastic resins
 Résine thermoplastique
 Kunststoff
 Resinas termoplásticas
 Термопластичных смол

D043-51 Kos.

TOP DESIGN



13
Cromato
 Chromed

Lampada a led per fissaggio a muro

Wall fastening LED lamp

Lampe LED pour fixation murale

LED-Lampe für die Wandbefestigung

Lámpara de led para fijación a la pared

Светодиодная лампа для настенного крепления

L50 x P10,3 x H3,5 cm
 LED 9W - 660 lumen

CLASS EXEMPT GROUP
 secondo norma EN 62471 - according with EN 62471

CE
 IP 44 - RoHS - 220-240V
 50-60 Hz - 6000°K - CRI >90

D042 Delos.

NEW

TOP DESIGN

Lampada a Led con attacco per specchi senza cornice (max. 4,5 mm)

LED light with socket for mirror without frame (max. 4,5 mm)

Lampe LED avec fixation pour miroirs sans cadre (max. 4,5 mm)

Led-Leuchte mit Befestigung für Spiegel ohne Rahmen (max. 4,5 mm)

Lámpara de led con fijación para espejos sin marco (max. 4,5 mm)

Светодиодная лампа с креплением на зеркала без рамы (max. 4,5 mm)

CE

IP 44 - RoHS - 220-240 V
50-60 Hz - 5600°K
4,7W - 600 lumen - CRI > 90

CLASS EXEMPT GROUP
secondo norma EN 62471 - according with EN 62471



Resine termoplastiche

Thermoplastic resins

Résine thermoplastique

Kunststoff

Resinas termoplásticas

Термопластичных смол

∅ 8,8 x 9,7 cm



13
Cromato
Chromed



14
Nero matt
Matt black

4943 Madeira.

GEDY

Lampada a Led con attacco universale per specchi con e senza cornice

LED lamp with universal fastening frame for mirrors with or without frame

Lampe LED universelle pour miroirs avec ou sans cadre

LED-Lampe mit Universalbefestigung für Spiegel mit und ohne Rahmen

Lámpara de led con fijación universal para espejos con y sin marco

Силиконовые форсунки и микроотверстия, которые обеспечивают экономию воды и усиливают напор струи

CE

IP 44 - RoHS

230V-50Hz - 6000°K - CRI 90

CLASSE ENERGETICA A
CLASS EXEMPT GROUP A
secondo normativa UE 874/2012
according with UE 874/2012

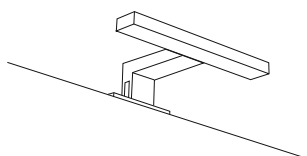

4943

L18 x P11,5 x H4,6 cm
LED 3,62W - 220 lumen

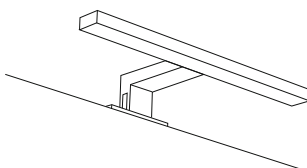

4943-30

L30 x P11,5 x H4,6 cm
LED 4,9W - 330 lumen

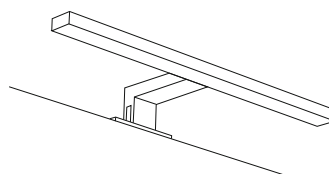

4943-45

L45 x P11,5 x H4,6 cm
LED 8W - 450 lumen



13
Cromato
Chromed

Specchi ingranditori

Magnifying mirrors - Miroirs grossissant - Beidseitiger Kosmetikspiegel
Espejos de aumento - Увеличительное зеркало



Acciaio inox e vetro

Stainless steel and glass

Acier inoxydable et verre

Edelstahl und Glas

Acero inox y cristal

нержавеющей стали и стекла

2118 Vincent.

TOP DESIGN

Specchio ingranditore da parete con luce LED

Wall magnifying mirror with LED light

Miroir grossissant à mural avec lumière LED

Wand-Kosmetikspiegel mit LED-Leuchte

Espejo de aumento de pared con luz LED

Увеличительный зеркало

со светодиодной подсветкой

∅ 25 x P12,3/36 cm



13
Cromato
Chromed



Supporto
estensibile

Extensible
holder



IP 42 - 230V - 11W
50Hz - 7400°K - 90 lumen - CRI 90



Acciaio inox AISI 304, ottone e vetro

Chromed AISI 304 stainless steel, brass and glass

Acier inoxydable AISI 304 chromé, laiton et verre

Verchromtem Edelstahl AISI 304, Messing und Glas

Acero inox AISI 304 cromado, latón y cristal

Нержавеющей стали AISI 304, латуни и стекла

2100 Sarah.

TOP DESIGN

Specchio ingranditore da parete con luce LED

Wall magnifying mirror with LED light

Miroir grossissant à mural avec lumière LED

Wand-Kosmetikspiegel mit LED-Leuchte

Espejo de aumento de pared con luz LED

Увеличительный зеркало

со светодиодной подсветкой

∅ 21,5x13/32 cm



13
Cromato
Chromed



14
Nero matt
Matt black



Supporto
estensibile

Extensible
holder



IP 44 - 110÷240V - 50/60Hz
LED 1,6W - 300 lumen - 4000°K - CRI 91

2104 Michel.

TOP DESIGN

Specchio ingranditore e non, bifacciale da parete

Two-way wall magnifying and non magnifying mirror

Miroir grossissant et non grossissant, double face

Spiegel mit und ohne Vergrößerung, zweiseitig

Espejo de aumento y normal, dos caras

Двустороннее зеркало, одна сторона с увеличением



Supporto
estensibile

Extensible
holder



Ø 18 cm

Ø 22,5 x P3-28,5 max. x H27,5 cm

Acciaio inox AISI 304, ottone e vetro

Stainless steel AISI 304, brass and glass

Acier inoxydable AISI 304, laiton et verre

Edelstahl AISI 304, Messing und Glas

Acero inox AISI 304, latón y cristal

Нержавеющей стали AISI 304, латуни и стекло



13
Cromato/lucido
Chromed/polished



14
Nero matt
Matt black

CO2024 Gaia.

NEW

GEDY

Specchio ingranditore e non, bifacciale

Double-sided mirror with magnification on one side

Miroir grossissant et non grossissant, double face

Spiegel mit und ohne Vergrößerung, zweiseitig

Espejo de aumento y normal, dos caras

Двустороннее зеркало, одна сторона с увеличением



Supporto
estensibile

Extensible
holder



Ø 18 cm

23-25 x 2-29,5 max. x 30 cm

Acciaio inox, vetro e Cromall®

Stainless steel, glass and Cromall®

Acier inoxydable, verre et Cromall®

Edelstahl, Glas und Cromall®

Acero inox, cristal y Cromall®

Нержавеющая сталь, стекло и Cromall®



13
Cromato
Chromed



14
Nero matt
Matt black



Specchio orientabile

Adjustable mirror



Con ventosa With screws

Resine termoplastiche e metallo
Thermoplastic resins and metal
Thermoplastique et métal
Kunststoff und Metall
Resinas termoplásticas y metal
Термопластичных смол и металл

H008 Hot.



13
Cromato
Chromed

GEDY

Specchio ingranditore e non, bifacciale, con fissaggio a ventosa

Double-side magnifying and non-magnifying mirror with suction cup fixing
Miroir double-face grossissant et non grossissant avec ventouse
beidseitiger Kosmetikspiegel mit und ohne Vergrößerung mit Saugnapf-Befestigung
Espejo de aumento y normal, dos caras fijación con ventosa
Двустороннее увеличительное и не увеличительное зеркало
Крепление при помощи присосок

L15 x 27 max x H22 cm

Solo su superfici lisce e non porose

For smooth, non-porous surfaces only - Uniquement sur des surfaces lisses et non poreuses - Nur auf glatten, nicht porösen Oberflächen
Solo en superficies lisas y no porosas - Только для гладких и непористых поверхностей

C02021. C02020 Lia.



13
Cromato
Chromed

GEDY

Specchio ingranditore da parete con ventose

Wall magnifying mirror with suction cups
Miroir grossissant avec à mural ventouses
Wand-Kosmetikspiegel mit Saugnapfen
Espejo de aumento de pared con ventosas
Двустороннее увеличительное с Крепление при помощи присосок

C02021



Ø 20 x 3 cm

C02020



Ø 15 x 3 cm

Solo su superfici lisce e non porose

For smooth, non-porous surfaces only - Uniquement sur des surfaces lisses et non poreuses - Nur auf glatten, nicht porösen Oberflächen
Solo en superficies lisas y no porosas - Только для гладких и непористых поверхностей



Metallo
Metal
Métal
Metall
Metal
Металл



Con ventosa With screws

CO2019 Ada.

GEDY

L20 x P11,8 x H32,3 cm

Metallo

Metal - Métal - Metall

Metal - Metall



Specchio ingranditore e non, bifacciale

Two way magnifying and non magnifying mirror

Miroir grossissant et non grossissant, double face
beidseitiger Kosmetikspiegel mit und ohne
Vergrößerung

Espejo de aumento y normal, dos caras

Двустороннее увеличительное

и не увеличительное зеркало



13
Cromato
Chromed

CO2023 Monica.

GEDY

L17,2 x P3,9 x H17,5 cm

Metallo

Metal - Métal - Metall

Metal - Metall



Specchio ingranditore e non, bifacciale

Two way magnifying and non magnifying mirror

Miroir grossissant et non grossissant, double face
beidseitiger Kosmetikspiegel mit und ohne
Vergrößerung

espejo de aumento y normal, dos caras

Двустороннее увеличительное

и не увеличительное зеркало



02
Bianco
White



13
Cromato
Chromed

CO2022 Elena.

GEDY

L16,5 x P1,8 x H19 cm

Resine termoplastiche

Thermoplastic resins

Thermoplastique - Kunststoff

Resinas termoplásticas термопластичных смол



Specchio ingranditore e non, bifacciale

Two way magnifying and non magnifying mirror

miroir grossissant et non grossissant, double face

beidseitiger Kosmetikspiegel mit und ohne

Vergrößerung

espejo de aumento y normal, dos caras

Двустороннее увеличительное и обычное зеркало



02
Bianco
White



76
Fucsia
Fuchsia



92
Turchese
Turquoise

CO2018.

GEDY

L17,6 x P10 x H25 cm

Resine termoplastiche

Thermoplastic resins

Thermoplastique - Kunststoff

Resinas termoplásticas термопластичных смол



Specchio ovale ingranditore e non, bifacciale

Oval two way magnifying and non magnifying mirror

Miroir ovale grossissant et non grossissant, double face

Ovaler beidseitiger Kosmetikspiegel mit und ohne Vergrößerung

Espejo ovalado de aumento y normal, dos caras

Двустороннее увеличительное и обычное зеркало



00
Trasparente
Transparent



05
Blu
Blue



79
Lilla
Lilac

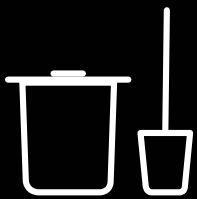

ACCESSORI WC

Wc accessories





Poubelles in acciaio inox

Stainless steel waste baskets - Corbeilles en acier inoxydable

Treiteimer aus Edelstahl - Cubos de basura en acero inox

Урны из нержавеющей стали



13
Lucido
Polished

TOP DESIGN

5209 Vesta - 6,6 lt

ø18,8 x H25 cm



13
Lucido
Polished

GEDY

2809 Argenta - 5 lt

L22,8 x P23,2 x H30 cm



13
Lucido
Polished

GEDY

2909 Argenta - 5 lt

L14 x P29,4 x H30 cm



13
Lucido
Polished



GEDY

2209 Argenta - 3 lt

L16,5 x P21,5 x H25 cm

Soft
close

14
Nero matt
Matt Black



13
Lucido
Polished



GEDY

2309 Argenta - 5 lt

L20,5 x P24 x H30 cm

Soft
close

14
Nero matt
Matt Black

Poubelles in acciaio inox - Stainless steel waste baskets.



13
Lucido
Polished

GEDY

2409 Argenta - 7 lt

L20,5 x P26,5 x H31,8 cm



13
Lucido
Polished

GEDY

2609 Argenta - 3 lt

L17 x P22,5 x H26 cm



13
Lucido
Polished

GEDY

2709 Argenta - 5 lt

L20,5 x P26,5 x H27,8 cm



13
Lucido
Polished

GEDY

3009 Grid - 3 lt

L17 x P22,5 x H26 cm



Potty.

GEDY



Soft close



02
Bianco matt
Matt white



14
Nero matt
Matt black



38
Spazzolato
Brushed



87
Oro matt
Matt gold



3309 - 5 lt

L20,6 x P26,8 x H27,5 cm



3209 - 3 lt

L17,4 x P22,6 x H25,1 cm

Kenta.

bambocom®

GEDY



40

Naturale/Bianco matt
Natural/Matt white



41

Naturale/Nero matt
Natural/Matt black

Realizzate in bambù e metallo

Made of bamboo and metal

Réalisés en bambou et métal

Hergestellt aus Bambus und Metall

Realizadas en bambù y metal

Изготовлено из бамбука и металл



Natural



Save
the planet



Bambù
Bamboo



1409 - 5 lt

ø 20,5 x 26 x 26,5 cm



1309 - 3 lt

ø 17 x 22 x 25 cm



Soft close

Poubelles in resine termoplastiche

Waste baskets in thermoplastic resins - Poubelles en résine thermoplastique
 Treteimer aus Kunststoff - Papeleras en resinas termoplásticas
 Урны из термопластичных смол

100% MADE
 in **Italy**



ACCESSORI WC
 Wc accessories



design
 Makio
 Hasuike



02
 Bianco
 White

GEDY

2009 Boxer - 10,8 lt

ø 22,5 x H31 cm



design
 Pedrizzetti
 e Associati



24
 Bianco/Nero
 White/Black

GEDY

1009 Peng - 7,5 lt

L22,9 x P23,8 x H34,5 cm



00
 Trasparente
 Transparent



02
 Bianco
 White

GEDY

GL09 Gladly - 6,6 lt

ø 21,1 x H25,4 cm



design
 Olaf Von Bohr



02
 Bianco
 White



08
 Grigio
 Grey



52
 Tortora
 Turtledove
 grey



65
 Blu petrolio
 Petrol blue



66
 Beige
 Beige



86
 Celeste
 Sky blue

GEDY

8009 Junior - 4,8 lt

L21 x P15 x H33 cm



P2
 Bianco
 White

GEDY

8609 Venezia - 6 lt

ø 23 x H24,5 cm

Seventy.

GEDY



08
Grigio
Grey



22
Bianco
White



27
Acquamarina
Aquamarine



52
Tortora
Turtledove



65
Blu petrolio
Petrol blue



66
Beige
Beige



86
Celeste
Sky blue

100% MADE
in Italy



6309 - 8 lt

L20 x P20 x H24,6 cm



6308 - 1,2 lt

L11,6 x P11,6 x H12,4 cm

Poubelle da tavolo

Table basket

Poubelle de table

Tischabfalleimer

Papelera de mesa

Контейнер для

мусора настольный

Poubelles in resine termoplastiche - Waste baskets in thermoplastic resins.

Eye.

GEDY



02
Bianco
White



08
Grigio
Grey



66
Beige
Beige

100% MADE
in **Italy**



1209 - 6 lt
ø 19 x H26,5 cm

Scopini wc da muro

Wall toilet brush holders
Porte-brosses wc mural
Wand-WC-Bürstengarnituren
Escobilleros de pared
Настенный, Туалетный ершик



15
YEARS

GARANZIA
WARRANTY



TOP DESIGN

5433-03 Lounge

L8,2 x P11,2 x H40 cm

Acciaio inox, Cromall® e alluminio

Stainless steel, Cromall® and alluminio

Acier inoxydable, Cromall® et aluminium

Edelstahl, Cromall® und aluminium

Acero inox, Cromall® y aluminio

нержавеющая сталь, Cromall® и алюминий



13
Cromato
Chromed



14
Nero matt
Matt Black

15
YEARS

GARANZIA
WARRANTY



TOP DESIGN

7633-03 Bridge

design Carlo Martino

L8 x P10 x H40,5 cm

Acciaio inox AISI 304, Cromall® e ottone

AISI 304 stainless steel, Cromall® and brass

Acier inoxydable AISI 304, Cromall® et laiton

Edelstahl AISI 304, Cromall® und Messing

Acero inox AISI 304, Cromall® y latón

нержавеющей стали AISI 304, Cromall® и латунные

Scopini wc da muro - Wall toilet brush holders .

15
YEARS
GARANZIA
WARRANTY

AISI
304



TOP DESIGN

3233-03 Outline

design Simone Micheli

L8 x P10 x H38,4 cm



13
Cromato
Chromed



22
Bianco matt
Matt white



14
Nero matt
Matt Black

15
YEARS
GARANZIA
WARRANTY



TOP DESIGN

2433-03 Perseo

L8,5 x P8,7 x H35,9 cm



13
Cromato
Chromed

Acciaio inox AISI 304, Cromall®, ottone e resine termoplastiche

AISI 304 stainless steel, Cromall®, brass and thermoplastic resins

Acier inoxydable AISI 304, Cromall®, laiton et thermoplastique

Edelstahl AISI 304, Cromall®, Messing und Kunststoff

Acero inox AISI 304, Cromall®, latón y resinas termoplásticas

нержавеющей стали AISI 304, Cromall®, латунные и термопластичные смолы

Ottone

Brass

Laiton

Messing

Latón

Латунные



RETAIL

4434-03 Teseo

L9 x P9 x H38 cm



13
Lucido
Polished



14
Nero matt
Matt black

15
YEARS
GARANZIA
WARRANTY

100%
AISI
304



CONTRACT

5034-03 Project

L8,6 x P9,5 x H37,9 cm



13
Lucido
Polished



38
Spazzolato
Brushed

Acciaio inox

Stainless steel

Acier inoxydable

Edelstahl

Acero inox

нержавеющая сталь

Acciaio inox AISI 304

AISI 304 stainless steel

Acier inoxydable AISI 304

Edelstahl AISI 304

Acero inox AISI 304

нержавеющей стали AISI 304

ACCESSORI WC . WC ACCESSORIES .



13
Lucido
Polished

10
YEARS

GARANZIA
WARRANTY



13
Lucido
Polished

GEDY

NE33-03 Nemesia

L9 x P9 x H38 cm

Acciaio inox

Stainless steel

Acier inoxydable

Edelstahl

Acero inox

нержавеющая сталь

GEDY

ED34-03 Edera

L7,7 x P8,5 x H40,3 cm

Acciaio inox

Stainless steel

Acier inoxydable

Edelstahl

Acero inox

нержавеющая сталь

Flip.

GEDY



02
Bianco
White



13
Lucido
Polished



14
Nero matt
Matt black



22
Bianco matt
Matt white



5233-03

L9,1 x P10 x H37,7 cm

Acciaio inox

Stainless steel

Acier inoxydable

Edelstahl

Acero inox

нержавеющая сталь

Scopini wc da muro - Wall toilet brush holders .



10
YEARS
GARANZIA
WARRANTY



GEDY

PI33-03 Pirenei

L8,4 x P10,4 x H37 cm

Cromall® e vetro

Cromall® and glass

Cromall® et verre

Cromall® und Glas

Cromall® y cristal

Cromall® и стекла



13
Cromato
Chromed



14
Nero matt
Matt Black



02
Bianco matt
Matt white

NEW



38
Spazzolato
Brushed

NEW



87
Oro
Gold

NEW



88
Oro matt
Matt gold

TRATTAMENTO PVD
PVD PLATED

15
YEARS
GARANZIA
WARRANTY



GEDY

5733-03 Glamour

L10 x P13 x H39 cm

Cromall® e vetro

Cromall® and glass

Cromall® et verre

Cromall® und Glas

Cromall® y cristal

Cromall® и стекла



13
Cromato
Chromed

100% MADE
in Italy



GEDY

8533-03 Oscar

L11 x P15,8 x H35 cm



02
Bianco
White



Con viti
With screws



Con biadesivo
With double
sided tape

design Matteo Thun

Resine termoplastiche

Thermoplastic resins

Thermoplastique

Kunststoff - Resinas termoplásticas

Термопластичные смолы

Biagio.

NEW

GEDY



Con biadesivo
With double
sided tape



10
YEARS
GARANZIA
WARRANTY



02
Bianco
White



38
Spazzolato
Brushed



**Scopino da terra e
da muro con spatola**

Toilet brush holder freestanding
and wall mounted with spatula
Porte-brosse WC à poser et
mural avec spatule
Wand-WC-Bürstengarnitur
zum Aufstellen oder
Aufhängen mit Schaber
Escobillero de suelo y
de pared con espátula
Напольный и
настенный туалетный
ершик с насадкой-скребком



6833

L11,4 x P7,7 x H45 cm



Acciaio inox e resine termoplastiche

Stainless steel and thermoplastic resins
Acier inoxydable et résine thermoplastique
Edelstahl und kunststoff
Acero inox y resinas termoplasticas
Нержавеющая сталь
и термопластичные смолы



Scopini wc

Toilet brush holders - Porte-brosses wc
WC-Bürstengarnituren
Escobilleros - Туалетный ершик



15
YEARS

GARANZIA
WARRANTY



TOP DESIGN

5433 Lounge

L8,2 x P8,2 x H40 cm

Acciaio inox e alluminio

Stainless steel and aluminium

Acier inoxydable et aluminium

Edelstahl und aluminium

Acero inox y aluminio

Нержавеющая сталь и алюминий



13
Cromato
Chromed



14
Nero matt
Matt Black

15
YEARS

GARANZIA
WARRANTY



TOP DESIGN

A033 Elba

L9,6 x P9,6 x H39,5 cm

Ottone, alluminio e vetro

Brass, aluminium and glass

Laiton, aluminium et verre

Messing, aluminium und Glas

Latón, aluminio y cristal

Латунные, алюминий и стекла



13
Cromato
Chromed

15
YEARS

GARANZIA
WARRANTY



13
Cromato
Chromed

TOP DESIGN

A233 Canarie

∅ 10 x H47 cm

Acciaio inox

Stainless steel - Acier inoxydable

Edelstahl - Acero inox - Нержавеющая сталь

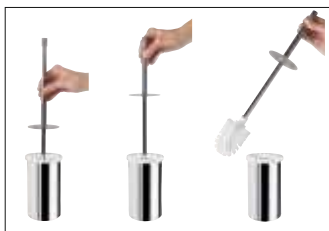

Manico telescopico

Telescopic handle
Manche télescopique
Ausziehbarem Stiel
Mango telescópico
Телескопической ручкой

15
YEARS

GARANZIA
WARRANTY



13
Cromato
Chromed

TOP DESIGN

7633 Bridge

design Carlo Martino

L8 x P8 x H40,5 cm

Acciaio inox

Stainless steel

Acier inoxydable

Edelstahl

Acero inox

Нержавеющая сталь

15
YEARS

GARANZIA
WARRANTY



13
Cromato
Chromed



22
Bianco matt
Matt white



14
Nero matt
Matt black

AISI
304

TOP DESIGN

3234 Outline

design Simone Micheli

L8 x P8 x H38,4 cm

Acciaio inox AISI 304, Cromall®, ottone e resine termoplastiche

AISI 304 stainless steel, Cromall®, brass and thermoplastic resins

Acier inoxydable AISI 304, Cromall®, laiton et thermoplastique

Edelstahl AISI 304, Cromall®, Messing und Kunststoff

Acero inox AISI 304, Cromall®, latón y resinas termoplásticas

Нержавеющей стали AISI 304, Cromall®, латунные и

термопластичные смолы

15
YEARS

GARANZIA
WARRANTY



13
Cromato
Chromed

AISI
304

TOP DESIGN

5633 Ulisse

L8,1 x P8,1 x H40 cm

Acciaio inox AISI 304 e resine termoplastiche

AISI 304 stainless steel and thermoplastic resins

Acier inoxydable AISI 304 et thermoplastique

Edelstahl AISI 304 und Kunststoff

Acero inox AISI 304 y resinas termoplásticas

Нержавеющая сталь AISI 304 и термопластичные смолы

10
YEARS

GARANZIA
WARRANTY



RETAIL

4433 Teseo

L9,6 x P9,6 x H37,2 cm

Acciaio inox

Stainless steel

Acier inoxydable

Edelstahl

Acero inox

нержавеющая сталь



13
Lucido
Polished



14
Nero matt
Matt Black

15
YEARS

GARANZIA
WARRANTY



CONTRACT

5034 Project

ø 8,6 x H37,9 cm

Acciaio inox AISI 304

AISI 304 stainless steel

Acier inoxydable AISI 304

Edelstahl AISI 304

Acero inox AISI 304

нержавеющей стали AISI 304

100%
AISI
304



13
Lucido
Polished



38
Spazzolato
Brushed

10
YEARS

GARANZIA
WARRANTY



GEDY

7533 Romance

ø 9 x H41 cm

Acciaio inox e Cromall®

Stainless steel and Cromall®

Acier inoxydable et Cromall®

Edelstahl und Cromall®

Acero inox y Cromall®

Нержавеющей стали и Cromall®



44
Bronzo
Bronze



GEDY

3833 Kansas

L8,7 x P8,7 x H36 cm

Acciaio inox

Stainless steel

Acier inoxydable

Edelstahl

Acero inox

нержавеющая сталь



13
Lucido
Polished



GEDY

EE33 Elettra

ø 8 x H46,8 cm



15
Rame
Copper



GEDY

2634 John

ø 8 x H38 cm



13
Cromato
Chromed



14
Nero matt
Matt Black

Acciaio inox

Stainless steel
Acier inoxydable
Edelstahl
Acero inox
нержавеющая сталь

Acciaio inox e resine termoplastiche

Stainless steel and thermoplastic resins
Acier inoxydable et thermoplastique
Edelstahl und Kunststoff
Acero inox y resinas termoplásticas
нержавеющая сталь и термопластичные смолы

10
YEARS

GARANZIA
WARRANTY



GEDY

2333 Argo

ø 9 x H39 cm



13
Lucido
Polished

10
YEARS

GARANZIA
WARRANTY



GEDY

3633 Mercurio

ø 8,3 x H33,6 cm



13
Cromato
Chromed

Acciaio inox

Stainless steel
Acier inoxydable
Edelstahl
Acero inox
нержавеющая сталь

Acciaio inox

Stainless steel
Acier inoxydable
Edelstahl
Acero inox
нержавеющая сталь



13
Lucido
Polished



GARANZIA
WARRANTY



13
Lucido
Polished

GEDY

2133 Winny

ø 9 x H39 cm

Acciaio inox

Stainless steel

Acier inoxydable

Edelstahl

Acero inox

нержавеющая сталь

GEDY

EP33 Edera Plus

ø 7,9 x H33,2 cm

Acciaio inox

Stainless steel

Acier inoxydable

Edelstahl

Acero inox

нержавеющая сталь



13
Lucido
Polished

GEDY

NE33 Nemesia

L9 x P9 x H38 cm

Acciaio inox

Stainless steel

Acier inoxydable

Edelstahl

Acero inox

нержавеющая сталь



21
Lucido/Spazzolato
Polished/Brushed

GEDY

PR33 Primula

ø 10 x H38 cm

Acciaio inox

Stainless steel

Acier inoxydable

Edelstahl

Acero inox

нержавеющая сталь

10
YEARS

GARANZIA
WARRANTY



GEDY

ED34 Edera

ø 7,5 x H40 cm



13
Lucido
Polished



GEDY

GE33 Genziana

ø 8 x H33,3 cm



02
Bianco
White



13
Lucido
Polished

Acciaio inox

Stainless steel

Acier inoxydable

Edelstahl

Acero inox

нержавеющая сталь

Acciaio inox

Stainless steel

Acier inoxydable

Edelstahl

Acero inox

нержавеющая сталь



GEDY

FE33 Felce

ø 8 x H33,3 cm



13
Lucido
Polished



GEDY

2733 Ascot

ø 9,1 x H38,6 cm



13
Lucido
Polished

Acciaio inox

Stainless steel

Acier inoxydable

Edelstahl

Acero inox

нержавеющая сталь

Acciaio inox

Stainless steel

Acier inoxydable

Edelstahl

Acero inox

нержавеющая сталь



GEDY

5233 Flip

ø 9,1 x H37,7 cm



02
Bianco
White



14
Nero matt
Matt black



13
Lucido
Polished



22
Bianco matt
Matt white

Acciaio inox

Stainless steel

Acier inoxydable

Edelstahl

Acero inox

нержавеющая сталь



GEDY

DS33 Diaspro

ø 10 x H39 cm



13
Lucido
Polished

Acciaio inox

Stainless steel

Acier inoxydable

Edelstahl

Acero inox

нержавеющая сталь



GEDY

C034 Oriente

ø 9,5 x H37 cm



13
Lucido
Polished

Acciaio inox e resine termoplastiche

Stainless steel and thermoplastic resins

Acier inoxydable et thermoplastique

Edelstahl und Kunststoff

Acero inox y resinas termoplásticas

нержавеющая сталь и термопластичные смолы



GEDY

1133 Ralph

ø 9,6 x H37,6 cm



13
Lucido
Polished

Acciaio inox e resine termoplastiche

Stainless steel and thermoplastic resins

Acier inoxydable et thermoplastique

Edelstahl und Kunststoff

Acero inox y resinas termoplásticas

нержавеющая сталь и термопластичные смолы

15
YEARS

GARANZIA
WARRANTY



GEDY

5533 Kent

L9,7 x P9 x H36,2 cm

Cromall® e vetro

Cromall® and glass

Cromall® et verre

Cromall® und Glas

Cromall® y cristal

Cromall® и стекла



13
Cromato
Chromed

15
YEARS

GARANZIA
WARRANTY



GEDY

5733 Glamour

L10 x P10 x H39 cm

Cromall® e vetro

Cromall® and glass

Cromall® et verre

Cromall® und Glas

Cromall® y cristal

Cromall® и стекла



02
Bianco
White



GEDY

PE33 Petunia

ø 9 x H44,8 cm

Acciaio inox,ceramica e resine termoplastiche

Stainless steel, pottery and thermoplastic resins

Acier inoxydable, céramique et thermoplastique

Edelstahl, Keramik und Kunststoff

Acero inox, cerámica y resinas termoplásticas

Нержавеющая сталь, керамики и термопластичные смолы



02
Bianco
White



GEDY

VE33 Verbena

L7,8 x P7,8 x H45,6 cm

Acciaio inox,ceramica e resine termoplastiche

Stainless steel, pottery and thermoplastic resins

Acier inoxydable, céramique et thermoplastique

Edelstahl, Keramik und Kunststoff

Acero inox, cerámica y resinas termoplásticas

Нержавеющая сталь, керамики и термопластичные смолы



02
Bianco
White

Scopini wc - Toilet brush holders .

Oscar.

100% MADE
in Italy

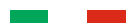

02
Bianco
White



14
Nero matt
Matt black



P0
Rosa
Pink



P1
Azzurro
Light blue



P2
Bianco opalino
Opaline white



P7
Acquamarina opalino
Opaline aquamarine

design Matteo Thun



08
Grigio
Grey



66
Beige
Beige



65
Blu petrolio
Petrol blue



27
Acquamarina
Aquamarine



86
Celeste
Sky blue



22
Bianco lucido
Polished white



8833

ø 13 x H35 cm

Resine termoplastiche

Thermoplastic resins

Thermoplastique

Kunststoff

Resinas termoplásticas

Термопластичные смолы

Peter.

100% MADE
in Italy



GEDY



08
Grigio
Grey



22
Bianco
White



52
Tortora
Turtledove
grey



65
Blu petrolio
Petrol blue



66
Beige
Beige



86
Celeste
Sky blue



Resine termoplastiche

Thermoplastic resins

Thermoplastique

Kunststoff

Resinas termoplásticas

Термопластичные смолы



6033

ø 14 x H41 cm

Junior.

100% MADE
in Italy



GEDY



02
Bianco
White



08
Grigio
Grey



52
Tortora
Turtledove
grey



65
Blu petrolio
Petrol blue



66
Beige
Beige



86
Celeste
Sky blue

design Giampiero Tonetti



Resine termoplastiche

Thermoplastic resins

Thermoplastique

Kunststoff

Resinas termoplásticas

Термопластичные смолы



8034

ø 12,5 x H37,5 cm

Scopini wc - Toilet brush holders .

Seventy.

100% MADE
in Italy



GEDY

design R & S Gedy



08
Grigio
Grey



22
Bianco
White



27
Acquamarina
Aquamarine



52
Tortora
Turtledove
grey



65
Blu petrolio
Petrol blue



66
Beige
Beige



79
Lilla
Lilac



86
Celeste
Sky blue



V7
Verde
pistacchio
Pistachio green



6334

L9 x P9 x H38,8 cm

Resine termoplastiche

Thermoplastic resins

Thermoplastique

Kunststoff

Resinas termoplásticas

Термопластичные смолы

ACCESSORI WC . WC ACCESSORIES .

Cucciolo.

GEDY

design Makio Hasuike

2033

ø 15 x H33,5 cm



02
Bianco
White

100% MADE
in Italy



MoMA June 27, 1977
In permanent Design Collection
of the Museum of Modern Art
in New York



**Dal 1977 fa parte
della collezione
permanente di design
del MOMA di New York.**

**Since 1977 it has been part
of the permanent collection
of design at the MOMA
New York City.**



CUCCIOLO LIMITED EDITION

70
Years
1953
2023

In occasione dei 70 anni della fondazione dell'Azienda, Gedy lancia in edizione limitata e numerata il suo Icon Item Cucciolo.

Con un packaging celebrativo, lo scopino Cucciolo si veste di nuovo in una tiratura di soli 1000 pezzi.

Gedy launches its icon item Cucciolo in a limited and numbered edition, on occasion of Company's 70th Anniversary.

The toilet brush holder gets a new look in an edition of only 1000 pieces with a celebratory packaging.



Seventy. **EK^opla**

NEW

GEDY



Save the planet



Riciclabile
Recyclable



Riciclato
Recycled

100% MADE
in **Italy**



08
Grigio matt
Matt grey



14
Nero matt
Matt black



22
Bianco matt
Matt white



07
Verde matt
Matt green



17
Verde salvia matt
Matt green sage



6333

L9 x P9 x H38,8 cm

Materiale plastico riciclato

Recycled plastic

Plastique recyclé

Recyceltes Kunststoffmaterial

Material plástico reciclado

Переработанный пластик

Scopini wc - Toilet brush holders .



GEDY

1733 Flou

ø 12,6 x H36 cm



02
Bianco
White



92
Turchese
trasparente
Transparent
turquoise



GEDY

3133 Moby

L11 x P10,9 x H37,8 cm



02
Bianco
White

100% MADE
in **Italy**



design Carallo - Grandis

Resine termoplastiche

Thermoplastic resins

Thermoplastique

Kunststoff

Resinas termoplásticas

Термопластичные смолы

design Babled & Co.

Resine termoplastiche

Thermoplastic resins

Thermoplastique

Kunststoff

Resinas termoplásticas

Термопластичные смолы



GEDY

8033 Junior

ø 13,5 x H39 cm



02
Bianco
White

100% MADE
in **Italy**



GEDY

ZE33 Zeno

ø 12,2 x H37,6 cm



02
Bianco
White

100% MADE
in **Italy**



design Giampietro Tonetti

Resine termoplastiche

Thermoplastic resins

Thermoplastique

Kunststoff

Resinas termoplásticas

Термопластичные смолы

Resine termoplastiche

Thermoplastic resins

Thermoplastique

Kunststoff

Resinas termoplásticas

Термопластичные смолы

Sedili wc

Toilet seats - Abattants - WC-Sitze
Asientos de inodoro - Туалетное сиденье



4026 Corniola.

GEDY

Realizzato in MDF con laccatura epossidica e cerniere in Cromall®
Made of epoxy lacquered M.D. with hinges Cromall®
Réalisé en M.D. avec laquage époxy et fixations en Cromall®
Hergestellt aus M.D. mit Epoxid-Beschichtung mit Befestigungen aus Cromall®
Realizado en DM pintado epoxi y bisagras de Cromall®
Туалетное сиденье из МДФ, покрытие эпоксидным лаком и петли из Cromall®



L37 x P47 x H7 cm



Soft close
Soft close



Fissaggio veloce
Fast fix



Universale
Universal



02
Bianco
White



02
Bianco
White



Universale
Universal



L37 x P44 x H5,8 cm

4007 Smeraldo.

GEDY

Realizzato in MDF con laccatura epossidica e cerniere in ottone cromato
Made of epoxy lacquered M.D. with chromed brass hinges
Réalisé en M.D. avec laquage époxy et fixations en laiton chromé
Hergestellt aus M.D. mit Epoxid-Beschichtung mit Befestigungen aus verchromtem Messing
Realizado en DM pintado epoxi y bisagras de latón cromado
Туалетное сиденье из МДФ покрытие эпоксидным лаком и хромированные латунные петли

4029 Acquamarina.

GEDY

Realizzato in MDF e cerniere in Cromall®
 Made of M.D. with Cromall® hinges
 Réalisé en M.D. et fixations en Cromall®
 Hergestellt aus M.D. mit Befestigungen aus Cromall®
 Realizado en DM y bisagras de Cromall®
 Туалетное сиденье из МДФ с петлями из Cromall®



L35,5 x P43 x H5,8 cm



Universale
 Universal



02
 Bianco
 White



Universale
 Universal



02
 Bianco
 White



L36,8 x P45,4 x H5,4 cm

4025 Agata.

GEDY

Realizzato in MDF con laccatura epossidica e cerniere in polipropilene
 Made of epoxy lacquered M.D. with polypropylene hinges
 Réalisé en M.D. avec laquage époxy et fixations en polypropylène
 Hergestellt aus M.D. mit Epoxid-Beschichtung mit Befestigungen aus Polypropylen
 Realizado en DM pintado epoxi con bisagras de polipropileno
 Туалетное сиденье из МДФ, покрытие эпоксидным лаком и полипропиленовые петли



02
 Bianco
 White

4009 Rubino.

GEDY

Sedile WC per sanitari modello disabili, realizzato in MDF con laccatura epossidica e cerniere in ottone cromato
 Toilet seat for disabled model bathroom fittings made of epoxy lacquered M.D. with chromed brass hinges
 Abattant pour sanitaires modèle porteurs de handicap réalisé en M.D. avec laquage époxy et fixations en laiton chromé
 WC-Sitz für Modell Behinderte, Hergestellt aus M.D. mit Epoxid-Beschichtung mit Befestigungen aus verchromtem Messing
 Asiento inodoro para sanitarios para minusválidos realizado en DM pintado epoxi y bisagras de latón cromado
 Сиденье для унитаза модели для инвалидов туалетное сиденье из МДФ покрытие эпоксидным лаком и хромированные латунные петли



L36,5 x P45,5 x H6 cm



Fissaggio
 inclinato a 45°
 Fastening 45°



02
 Bianco
 White



L34 x P46 x H5 cm

4022.

GEDY

Sedile WC per sanitari modello Conca, realizzato in MDF con laccatura epossidica e cerniere in ottone cromato
 Toilet seat for Conca sanitary fixtures made of epoxy lacquered M.D. with chromed brass hinges
 Abattant pour sanitaires modèle Conca réalisé en M.D. avec laquage époxy et fixations en laiton chromé
 WC-Sitz für Modell Conca, Hergestellt aus M.D. mit Epoxid-Beschichtung mit Befestigungen aus verchromtem Messing
 Asiento de inodoro para sanitarios modelo Conca realizado en DM pintado epoxi y bisagras de latón cromado
 Сиденье для унитаза модели Conca, туалетное сиденье из МДФ покрытие эпоксидным лаком и хромированные латунные петли

4023.

GEDY

Sedile WC per sanitari modello Tesi, realizzato in MDF con laccatura epossidica e cerniere in ottone cromato

Toilet seat for Tesi sanitary fixtures made of epoxy lacquered M.D. with chromed brass hinges

Abattant pour sanitaires modèle Tesi réalisé en M.D. avec laquage époxy et fixations en laiton chromé

WC-Sitz für Modell Tesi, Hergestellt aus M.D. mit Epoxid-Beschichtung mit Befestigungen aus verchromtem Messing

Asiento de inodoro para sanitarios modelo Tesi realizado en DM pintado epoxi y bisagras de latón cromado

Сиденье для унитаза модели Tesi, туалетное сиденье из МДФ покрытие эпоксидным лаком и хромированные латунные петли



L35 x P45 x H5,7 cm

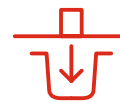

Fissaggio a espansione dall'alto

Top fast fix



02

Bianco
White



Fissaggio a espansione dall'alto

Top fast fix



02

Bianco
White



L35 x P46,5 x H5,9 cm

4014.

GEDY

Sedile WC per sanitari modello Ellisse, realizzato in MDF con laccatura epossidica e cerniere in ottone cromato

Toilet seat for Ellisse sanitary fixtures made of epoxy lacquered M.D. with chromed brass hinges

Abattant pour sanitaires modèle Ellisse réalisé en M.D. avec laquage époxy et fixations en laiton chromé

WC-Sitz für Modell Ellisse, Hergestellt aus M.D. mit Epoxid-Beschichtung mit Befestigungen aus verchromtem Messing

Asiento de inodoro para sanitarios modelo Ellisse realizado en DM pintado epoxi y bisagras de latón cromado

Сиденье для унитаза модели Ellisse, туалетное сиденье из МДФ покрытие эпоксидным лаком и хромированные латунные петли



Fissaggio a espansione dall'alto

Top fast fix



02

Bianco
White



L36 x P47 x H5,5 cm

4024.

GEDY

Sedile WC per sanitari modello Aretusa, realizzato in MDF con laccatura epossidica e cerniere in ottone cromato

Toilet seat for Aretusa sanitary fixtures made of epoxy lacquered M.D. with chromed brass hinges

Abattant pour sanitaires modèle Aretusa réalisé en M.D. avec laquage époxy et fixations en laiton chromé

WC-Sitz für Modell Aretusa, Hergestellt aus M.D. mit Epoxid-Beschichtung mit Befestigungen aus verchromtem Messing

Asiento de inodoro para sanitarios modelo Aretusa realizado en DM pintado epoxi y bisagras de latón cromado

Сиденье для унитаза модели Aretusa, туалетное сиденье из МДФ покрытие эпоксидным лаком и хромированные латунные петли



Fissaggio a espansione dall'alto

Top fast fix



02

Bianco
White



L35 x P48 x H5,8 cm

4027.

GEDY

Sedile WC per sanitari modello Sintesi, realizzato in MDF con laccatura epossidica e cerniere in ottone cromato

Toilet seat for Sintesi sanitary fixtures made of epoxy lacquered M.D. with chromed brass hinges

Abattant pour sanitaires modèle Sintesi réalisé en M.D. avec laquage époxy et fixations en laiton chromé

WC-Sitz für Modell Sintesi, Hergestellt aus M.D. mit Epoxid-Beschichtung mit Befestigungen aus verchromtem Messing

Asiento de inodoro para sanitarios modelo Sintesi realizado en DM pintado epoxi y bisagras de latón cromado

Сиденье для унитаза модели Sintesi, туалетное сиденье из МДФ покрытие эпоксидным лаком и хромированные латунные петли



Fissaggio a espansione dall'alto

Top fast fix



02
Bianco
White



L36 x P41,5 x H6 cm

4028.

GEDY

Sedile WC per sanitari modello Victoria, realizzato in MDF con laccatura epossidica e cerniere in ottone cromato
Toilet seat for Victoria sanitary fixtures made of epoxy lacquered M.D. with chromed brass hinges
Abattant pour sanitaires modèle Victoria réalisé en M.D. avec laquage époxy et fixations en laiton chromé
WC-Sitz für Modell Victoria, Hergestellt aus M.D. mit Epoxid-Beschichtung mit Befestigungen aus verchromtem Messing
Asiento de inodoro para sanitarios modelo Victoria realizado en DM pintado epoxi y bisagras de latón cromado
Сиденье для унитаза модели Victoria, туалетное сиденье из МДФ покрытие эпоксидным лаком и хромированные латунные петли



Fissaggio a espansione dall'alto

Top fast fix



02
Bianco
White



L34,4 x P44,7 x H6 cm

4030.

GEDY

Sedile WC per sanitari modello System, realizzato in MDF con laccatura epossidica e cerniere in ottone cromato
Toilet seat for System sanitary fixtures made of epoxy lacquered M.D. with chromed brass hinges
Abattant pour sanitaires modèle System réalisé en M.D. avec laquage époxy et fixations en laiton chromé
WC-Sitz für Modell System, Hergestellt aus M.D. mit Epoxid-Beschichtung mit Befestigungen aus verchromtem Messing
Asiento de inodoro para sanitarios modelo System realizado en DM pintado epoxi y bisagras de latón cromado
Сиденье для унитаза модели System, туалетное сиденье из МДФ покрытие эпоксидным лаком и хромированные латунные петли



Decoro metallico
Decorative metal plate



Universale
Universal



L37,5 x P44,5 x H6 cm



02
Open



06
Gas

C042 Onice.

GEDY

Realizzato in MDF con laccatura epossidica e decoro metallico, dotato di cerniere in ottone cromato
Made of epoxy lacquered M.D with decorative metal plate, chromed brass hinges
Réalisé en M.D. avec laquage époxy et plaque de métal, fixations en laiton chromé
Hergestellt aus M.D. mit Epoxid-Beschichtung mit Metall-Dekor, mit Befestigungen aus verchromtem Messing
Realizado en DM pintado epoxi con placa metálica, bisagras de latón cromado
Изготовлено из МДФ с металлической пластиной, покрытие эпоксидным лаком и петли из хромированной латуни

4017 Diamante.

GEDY

Realizzato in resine termoindurenti, dotato di cerniere in resine termoplastiche
Made of thermosetting resins with adjustable plastic hinges
Réalisé en thermodurcissable avec fixations réglables en thermoplastique
Hergestellt aus Duroplast mit Befestigungen aus Kunststoff
Realizado en resinas termoestables con bisagras de resinas termoestables
Изготовлено из термореактивных пластмасс.
Петли из термопластичных смол



Universale
Universal



02
Bianco
White



L37,3 x P45,7 x H5,7 cm

4001 Ametista.

GEDY

Realizzato in resine termoindurenti con cerniere in acciaio inox

Made of thermosetting resins, hinges of stainless steel

Réalisé en thermodurcissable, fixations en acier inoxydable

Hergestellt aus Duroplast mit Scharniere aus Edelstahl

Realizado en resinas termoestables con bisagras de acero inoxidable

Изготовлено из термореактивных пластмасс с петлями из нержавеющей стали



L37,8 x P45,7 x H5 cm



02
Bianco
White



Soft close
Soft close



Sgancio facile
Easy detach



Igiene facile
Easy clean



Universale
Universal

4004 Topazio.

GEDY

NEW

Realizzato in resine termoindurenti con cerniere in acciaio inox e nylon

Made of thermosetting resins, hinges of stainless steel and nylon

Réalisé en thermodurcissable, fixations en acier inoxydable et nylon

Hergestellt aus Duroplast mit Scharniere aus Edelstahl und Nylon

Realizado en resinas termoestables con bisagras de acero inoxidable y nailon

Изготовлено из термореактивных пластмасс с петлями из нержавеющей стали и нейлон



02
Bianco
White



con Antibatterico
with Antibacterial



Fissaggio
veloce
Fast fix

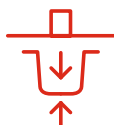

Doppio fissaggio
ALTO - BASSO
Double fix
TOP - BOTTOM



36,3 x 43,6 x 4,5 cm



Universale
Universal



Soft close
Soft close



Sgancio facile
Easy detach



Igiene facile
Easy clean



Fissaggio a
espansione dall'alto
Top fast fix



Universale
Universal



02
Bianco
White



L37,2 x P45,8 x H5,4 cm

4003 Zircono.

GEDY

Realizzato in resine termoindurenti con cerniere in acciaio inox
 Made of thermosetting resins, hinges of stainless steel
 Réalisé en thermodurcissable, fixations en acier inoxydable
 Hergestellt aus Duroplast mit Scharniere aus Edelstahl
 Realizado en resinas termoestables con bisagras de acero inoxidable
 Изготовлено из термореактивных пластмасс с петлями из нержавеющей стали

4031 Madreperla.

GEDY



02
Bianco
White

Realizzato in polipropilene con cerniere in polipropilene
 Made of polypropylene with polypropylene hinges
 Réalisé en polypropylène avec fixations en polypropylène
 Hergestellt aus Polypropylen mit Befestigungen aus Polypropylen
 Realizado en polipropileno con bisagras de polipropileno
 Изготовлено из Полипропиленовые на петли Полипропиленовые



L36,3 x P45 x H5,2 cm



Universale
Universal



Soft close
Soft close



Fissaggio a
espansione dall'alto
Top fast fix



02
Bianco
White

100% MADE
in Italy



L37 x P45,5 x H4,5 cm

4019 Oscar.

GEDY

Realizzato in polipropilene con cerniere in polipropilene
 Made of polypropylene with polypropylene hinges
 Réalisé en polypropylène avec fixations en polypropylène
 Hergestellt aus polypropylène mit Befestigungen aus Polypropylen
 Realizado en polipropileno con bisagras de polipropileno
 Изготовлено из Полипропиленовые на петли Полипропиленовые



Universale
Universal

4008 Ambra.

GEDY

Realizzato in resine termoplastiche con cerniere in polietilene
 Made of thermoplastic resin with polythene hinges
 Réalisé en thermoplastique avec fixations en polythène
 Hergestellt aus Kunststoff mit Befestigungen aus Polyäthylen
 Realizado en resinas termoplásticas con bisagras de politeno
 Изготовлено из термопластичных смол на петли полиэтилен



L37,5 x P46,5 x H3 cm



Universale
Universal



02
Bianco
White

100% MADE
in Italy





COMPLEMENTI
D'ARREDO

Furnishing accessories





P i a n t a n e

Towel stands - Porte serviettes - Handtuchständer
Toalleros de pie - Стойка для полотенец



7631

H92 cm

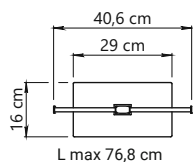

7632

H69 cm

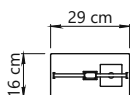

Bridge.

TOP DESIGN

Acciaio inox, Cromall® e ottone

Stainless steel, Cromall® and brass

Acier inoxydable, Cromall® et laiton

Edelstahl, Cromall® und Messing

Acero inox, Cromall® y latón

Нержавеющей стали, Cromall® и латунные



13
Cromato
Chromed



GARANZIA
WARRANTY

Florida.

RETAIL

Acciaio inox, Cromall® e resine termoplastiche

Stainless steel, Cromall® and thermoplastic resins
 Acier inoxydable, Cromall® et résine thermoplastique
 Edelstahl, Cromall® und Kunststoff
 Acero inox, Cromall® y resinas termoplásticas
 нержавеющей сталь, Cromall® и термопластичные смолы



13
Cromato
 Chromed



14
Nero matt
 Matt black



GARANZIA
WARRANTY



7331
 H89,9 cm

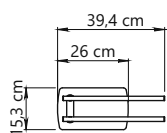

7332
 H64,4 cm

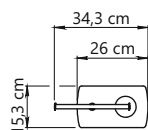

Artù.

RETAIL

Acciaio inox e Cromall®

Stainless steel and Cromall®

Acier inoxydable et Cromall®

Edelstahl und Cromall®

Acero inox y Cromall®

Нержавеющей стали и Cromall®



13
Cromato
Chromed



14
Nero matt
Matt black



GARANZIA
WARRANTY



1131

H83,6 cm

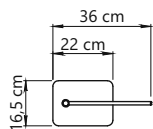

1132

H66,7 cm

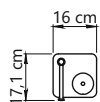

Artù.



03

Cromato/Beige
Chromed/Beige



GARANZIA
WARRANTY

Acciaio inox, Cromall®, resina e sabbia

Stainless steel, Cromall®, resin and sand

Acier inoxydable, Cromall®, résine et sable

Edelstahl, Cromall®, Harz und Sand

Acero inox, Cromall®, resina y arena

Нержавеющей стали, Cromall®, смол и песчаника

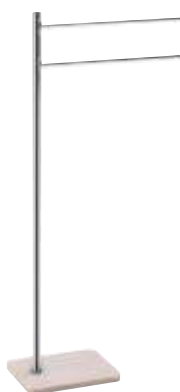

1131

H84,9 cm

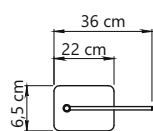

1132

H67,8 cm

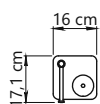

Maine.

GEDY

Acciaio inox, Cromall® e resine termoplastiche

Stainless steel, Cromall® and thermoplastic resins

Acier inoxydable, Cromall® et thermoplastique

Edelstahl, Cromall® und Kunststoff

Acero inox, Cromall® y resinas termoplásticas

нержавеющая сталь, Cromall® и термопластичные смолы



13
Cromato
Chromed



GARANZIA
WARRANTY



7831

H89,4 cm

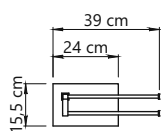

7832

H69,7 cm

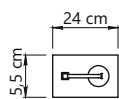

Tobia.

GEDY

Acciaio inox e resine termoplastiche

Stainless steel and thermoplastic resins

Acier inoxydable et thermoplastique

Edelstahl und Kunststoff

Acero inox y resinas termoplásticas

нержавеющая сталь и термопластичные смолы



13
Cromato
Chromed



GARANZIA
WARRANTY



7131

H89 cm

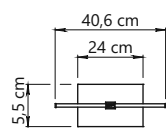

7132

H75 cm

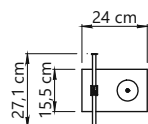

Virginia.

GEDY

Acciaio inox e resine termoplastiche

Stainless steel and thermoplastic resins

Acier inoxydable et thermoplastique

Edelstahl und Kunststoff

Acero inox y resinas termoplásticas

нержавеющая сталь и термопластичные смолы



13
Cromato
Chromed



GARANZIA
WARRANTY



2131

H87 cm

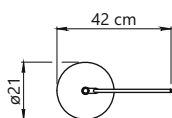

2132

H61 cm

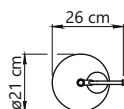

Felix.

NEW

GEDY



13
Cromato
Chromed



GARANZIA
WARRANTY

Acciaio inox, metallo e resine termoplastiche

Stainless steel, metal and thermoplastic resins

Acier inoxydable, métal et thermoplastique

Edelstahl, Metall und Kunststoff

Acero inox, metal y resinas termoplásticas

Нержавеющая сталь, металла и термопластичные смолы



1331

H77,8 cm

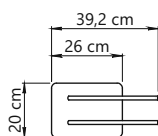

1332

H69,8 cm

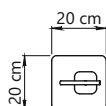

Tracy.

GEDY



13
Cromato
Chromed

Metallo con contenitore in vetro satinato

Metal with frosted glass container

Métal avec boîtier en verre satiné

Metall mit Behälter aus satiniertem Glas

Metal con contenedore en cristal satinado

Металла с ёмкостями из матового стекла



2731

H94,3 cm

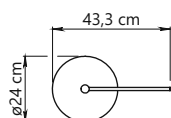

2732

H77,5 cm

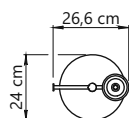

Circe.

NEW

GEDY



13
Cromato
Chromed



GARANZIA
WARRANTY

Acciaio inox, metallo e resine termoplastiche

Stainless steel, metal and thermoplastic resins

Acier inoxydable, métal et thermoplastique

Edelstahl, Metall und Kunststoff

Acero inox, metal y resinas termoplásticas

нержавеющая сталь, металла и термопластичные смолы



1431

H79,8 cm

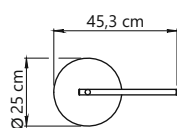

1432

H61,7 cm

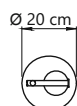

Rainbow.

GEDY

Acciaio inox e resine termoplastiche

Stainless steel and thermoplastic resins

Acier inoxydable et thermoplastique

Edelstahl und Kunststoff

Acero inox y resinas termoplásticas

нержавеющая сталь и термопластичные смолы

Colori trasparenti - Transparent colours:



02
Bianco
White



04
Verde acido
Acid green



05
Blu
Blue



06
Rosso
Red



14
Nero
Black



52
Tortora
Turtledove
grey



RA31

H83,9 cm

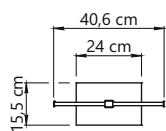

P i a n t a n e - T o w e l s t a n d s .

Colori pieni - Solid colours:

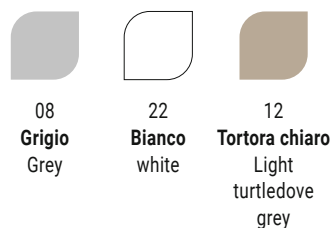

**GARANZIA
WARRANTY**



RA32

H58,8 cm

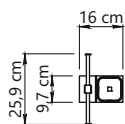

Winny.

GEDY

design Piet Billekens

Acciaio inox

Stainless steel

Acier inoxydable

Edelstahl

Acero inox

Нержавеющей стали



02
Bianco
White



13
Cromato
Chromed



GARANZIA
WARRANTY



2831

H90 cm

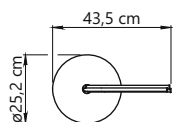

2832

H76,7 cm

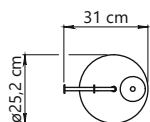

Golia.

NEW

GEDY



13
Cromato
Chromed

Metallo, resine termoplastiche e vetro

Metal, thermoplastic resins and glass

Métal, résine thermoplastique et verre

Metall, Kunststoff und Glas

Metal, resinas termoplásticas y cristal

Металла, термопластичных смол и стекла

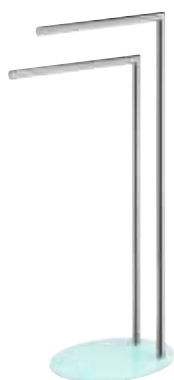

1231

H81,4 cm

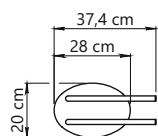

1232

H71,8 cm

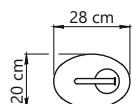

Trilly.

Acciaio inox e Cromall®

Stainless steel and Cromall®

Acier inoxydable et Cromall®

Edelstahl und Cromall®

Acero inox y Cromall®

Нержавеющей стали и Cromall®



13
Cromato
Chromed



22
Bianco
White



GARANZIA
WARRANTY



14
Nero matt
Matt black



TR31

H83,5 cm

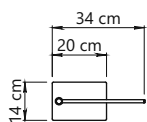

TR32

H63 cm



Trilly.

GEDY

Acciaio inox, Cromall®, resina e sabbia

Stainless steel, Cromall®, resin and sand

Acier inoxydable, Cromall®, résine et sable

Edelstahl, Cromall®, Harz und Sand

Acero inox, Cromall®, resina y arena

Нержавеющей стали, Cromall®, смолы и песка



03

Cromato/Beige
Chromed/Beige



08

Cromato/Grigio
Chromed/Grey



GARANZIA
WARRANTY



TR31

H84,5 cm

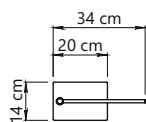

TR32

H64 cm



Trilly.

NEW



88
Oro spazzolato
Brushed gold

10
YEARS

GARANZIA
WARRANTY



TR31

H83,5 cm

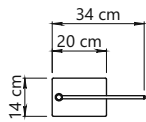

TR32

H63 cm



Trilly.

GEDY

Piantane - Towel stands .

NEW

38
Spazzolato
Brushed

Acciaio inox e Cromall®
Stainless steel and Cromall®
Acier inoxydable et Cromall®
Edelstahl und Cromall®
Acero inox y Cromall®
Нержавеющей стали и Cromall®



TR31

H83,5 cm

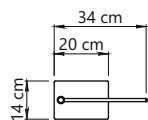

TR32

H63 cm



Trilly.

bamboocom

GEDY

Acciaio inox e bambù

Stainless steel and bamboo

Acier inoxydable et bambou

Edelstahl und bambus

Acero inox y bambú

Нержавеющей стали и Бамбука



41
Naturale/Nero matt
Natural/Matt black



GARANZIA
WARRANTY



Natural



Save
the planet



Bambù
Bamboo



TR31

H84 cm

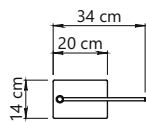

TR32

H63 cm



Hibiscus.

GEDY

Metallo e resine termoplastiche

Metal and thermoplastic resins

Métal et résine thermoplastique

Metall und Kunststoff

Metal y resinas termoplásticas

Металла и термопластичных смол



13
Cromato
Chromed



HI31
H90,5 cm

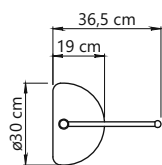

HI32
H75 cm

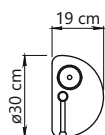

Mammolo.

GEDY

Alluminio, acciaio inox e resine termoplastiche

Aluminum, stainless steel and thermoplastic resins

Aluminium, acier inoxydable et résine thermoplastique

Aluminium, Edelstahl und Kunststoff

Aluminio, acero inox y resinas termoplásticas

Алюминий, нержавеющей стали и термопластичных смол



02
Bianco
White



GARANZIA
WARRANTY

100% MADE
in Italy



MM31

H89 cm

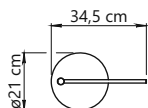

MM32

H77,3 cm



Minù.

GEDY

Piantana con portarotolo di riserva - metallo

Freestanding spare toilet paper roll holder - metal

Support de papier WC sur pied - métal

Ständer Ersatzrollenhalterung - Metall

Soporte portarrollos de reserva - metal

Держатель запасного рулона - металла



13
Cromato
Chromed



14
Nero matt
Matt black



MU37

H61 cm

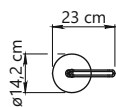

Wendy.

GEDY

design Babled e Co.

Resine termoplastiche

Thermoplastic resins

Résine thermoplastique

Kunststoff

Résinas termoplásticas

Термопластичных смол



02
Bianco
White



58
Bianco/
tortora chiaro
White/light
turtledove grey



71
Bianco/grigio
White/grey



89
Bianco/blu
White/blue

100% MADE
in Italy



7032

H69,8 cm

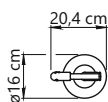

Panda.

bambocom

GEDY

Bambù

Bamboo
Bambou
Bambus
Bambú
Бамбука



35
Naturale
Natural



Natural



Save
the planet



Bambù
Bamboo



1031

H190 cm

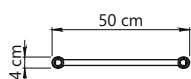

Appendiabiti

Hooks - Crochets - Haken
Perchas - Крючки



A626 Maldive.

TOP DESIGN

Cromall®



L3 x P3 x H9 cm

15
YEARS

GARANZIA
WARRANTY



13
Cromato
Chromed

Ustica.

TOP DESIGN

Alluminio

Aluminum
Aluminium
Aluminium
Aluminio
Алюминия



D028

ø 5,9 x H4 cm



D026

L11,5 x P4 x H5,3 cm



Con biadesivo
With double
sided tape



13
Cromato
Chromed

15
YEARS

GARANZIA
WARRANTY

Ottone

Brass
Laiton
Messing
Latón
Латунь



D027

ø 3,5 x H4,4 cm



Con viti
With screws

Malta.

TOP DESIGN

Alluminio
 Aluminum
 Aluminium
 Aluminium
 Aluminio
 Алюминия



D127

L5,3 x P5,3 x H4 cm



D126

L11,5 x P4 x H5,3 cm



Con biadesivo
 With double
 sided tape



GARANZIA
 WARRANTY



13
Cromato
 Chromed

Canarie.

TOP DESIGN

Ottone
 Brass
 Laiton
 Messing
 Latón
 Латунь



A227

ø1,9 x H3,4 cm



A226

L7 x P3,5 x H1,8 cm



A228

L17,2 x P3,5 x H1,8 cm



13
Cromato
 Chromed



GARANZIA
 WARRANTY

Demetra.

TOP DESIGN

Ottone
 Brass
 Laiton
 Messing
 Latón
 Латунь



5127

L4,5 x P6,7 x H6 cm
 2 pz - 2 pcs



5126

L4,5 x P6,7 x H6 cm



13
Cromato
 Chromed



GARANZIA
 WARRANTY

3626 Gea.

TOP DESIGN

Alluminio e ottone
 Aluminum and brass
 Aluminium et laiton
 Aluminium und Messing
 Aluminio y latón
 Алюминия и латунь



L5,5 x P4,3 x H6,3 cm



Con biadesivo
 With double
 sided tape



GARANZIA
 WARRANTY



13
Cromato
 Chromed

3426 Oz.

TOP DESIGN

Cromall®



L2,5 x P2,8 x H5,5 cm



Con biadesivo
 With double
 sided tape



Con viti
 With screws



GARANZIA
 WARRANTY



13
Cromato
 Chromed

4226 Vermont Pro.

RETAIL

Cromall®



L6,9 x P5,1 x H6 cm



Con colla
With glue

(Venduta a parte
Sold seperately)



Con viti
With screws

10
YEARS

GARANZIA
WARRANTY



13
Cromato
Chromed

Ciclope.

GEDY

Cromall® e ottone

Cromall® and brass

Cromall® et laiton

Cromall® und Messing

Cromall® y latón - Cromall® и латунь



2128

L20 x P3,1 x H4 cm



2127

ø 1,8 x P3 cm
2 pz - 2 pcs

15
YEARS

GARANZIA
WARRANTY



13
Cromato
Chromed

Ottone

Brass - Laiton

Messing - Latón - латунь

Gulliver.

GEDY

Ottone

Brass

Laiton

Messing

Latón

латунь



2228

L20,5 x P3,3 x H4,6 cm



2226

L8,3 x P3,3 x H4,6 cm

15
YEARS

GARANZIA
WARRANTY



13
Cromato
Chromed

Cordelia.

GEDY

Ottone

Brass - Laiton

Messing

Latón

латунь



2229

ø 1,6 x P5,5 cm
2 pz - 2 pcs



2227

ø 1,6 x P3 cm
2 pz - 2 pcs

15
YEARS

GARANZIA
WARRANTY



13
Cromato
Chromed

FJ27 Fuji.

GEDY

Cromall®



L4,7 x P4,9 x H4,7 cm
2 pz - 2 pcs



Con biadesivo
With double
sided tape



Con viti
With screws

15
YEARS

GARANZIA
WARRANTY



13
Cromato
Chromed



38
Spazzolato
Brushed

NEW

Colorado.

GEDY

Cromall®



6926

L4,2 x P5 x H4,2 cm



6928

L6,5 x P6 x H4,2 cm



Con colla
With glue

(Venduta a parte
Sold seperately)



Con viti
With screws



15
YEARS
GARANZIA
WARRANTY



13
Cromato
Chromed

H026 Hot.

GEDY

Resine termoplastiche e metallo

Thermoplastic resins and metal

Résine thermoplastique et métal

Kunststoff und Metall

Resinas termoplásticas y metal

Термопластичные смолы и металла



L6,3 x P4,5 x H10,8 cm



Con ventosa
With suction cup



13
Cromato
Chromed



14
Nero matt
Matt black

VS26 Vesuvio.

GEDY

Resine termoplastiche

Thermoplastic resins

Résine thermoplastique

Kunststoff

Resinas termoplásticas

Термопластичные смолы



L11,3 x P3 x H11 cm



Con ventosa
With suction cup



02
Bianco
White

VN26 Ventus.

GEDY

ABS



L6 x P5 x H6 cm



Con ventosa
With suction cup



10
YEARS
GARANZIA
WARRANTY



13
Cromato
Chromed

6000. 6027.

GEDY

design Ambrogio Rossari

Resine termoplastiche

Thermoplastic resins

Résine thermoplastique - Kunststoff

Resinas termoplásticas - Термопластичные смолы



L4,9 x P4,2 x H10,5 cm

100% MADE
in Italy



02
Bianco
White

Juncos.

bamboom

GEDY



41
Naturale/Nero matt
Natural/Matt black

Bambù e metallo

Bamboo and metal
Bambou et métal
Bambus und Metall
Bambú y metal
Бамбука и металл



Con biadesivo
With double
sided tape



Natural



Save
the planet



Bambù
Bamboo



1126

ø 5 x P3,8 cm



1127

L10 x P3,8 x H5 cm



1126

L5 x P3,8 x H5 cm



1127

L10 x P3,8 x H5 cm



Rainbow.

GEDY



Con biadesivo
With double
sided tape

Resine termoplastiche

Thermoplastic resins
Résine thermoplastique
Kunststoff
Resinas termoplásticas
Термопластичные смолы



Appendiabiti - Hooks.

COLORI PIENI - SOLID COLOURS



01
Tortora
Turtledove grey



12
Tortora chiaro
Light
turtledove grey

COLORI TRASPARENTI TRANSPARENT COLOURS



04
Verde acido
Acid green



05
Blu
Blue



06
Rosso
Red



52
Tortora
Turtledove grey



66
Tortora chiaro
Light
turtledove
grey



67
Arancione
Orange



79
Lilla
Lilac

RA26

L8 x P3,1 x H4 cm

COLORI TRASPARENTI TRANSPARENT COLOURS



04
Verde acido
Acid green



05
Blu
Blue



06
Rosso
Red



14
Nero
Black



67
Arancione
Orange



79
Lilla
Lilac

RA27

L4,3 x P3,4 x H6,5 cm

Merlino.

bamboom

GEDY



35
Naturale
Natural



Natural



Save
the planet



Bambù
Bamboo



2026

L2,5 x P5,7 x H12,5 cm



Realizzate in bambù

Made of bamboo
Réalisés en bambou
Hergestellt aus Bambus
Realizadas en bambù
Изготовлено из бамбука

Appendiabiti per termoarredi - Hanging hook for designer radiators.

Merlino.

100% MADE
in Italy

GEDY

COLORI PIENI - SOLID COLOURS



02
Bianco
White



08
Grigio
Grey



13
Cromato
Chromed



14
Nero
Black



27
Acquamarina
Aquamarine



52
Tortora
Turtledove grey



65
Blu petrolio
Petrol blue



66
Beige
Beige



86
Celeste
Sky blue

COLORI TRASPARENTI
TRANSPARENT COLOURS



00
Trasparente
Transparent



29
Moka
Moka



85
Antracite
Anthracitey



P0
Fucsia
Fuchsia



P1
Blu
Blue



P4
Arancione
Orange



P8
Verde acido
Acid green



P9
Lilla
Lilac



2025

L3,2 x P6,7 x H11,7 cm

Resine termoplastiche

Thermoplastic resins
Résine thermoplastique
Kunststoff
Resinas termoplásticas
Термопластичные смолы

Appendiabiti sopra porta

Over door clothes hooks - Crochets à accrocher à la porte
 Tür-Kleiderhaken - Perchas para colgar la ropa por encima de la puerta
 Вешалка для одежды, крепящаяся над дверью

Morgana.

GEDY

Acciaio inox

Stainless steel
 Acier inoxydable
 Edelstahl
 Acero inox
 нержавеющей стали



GARANZIA
 WARRANTY



13
Lucido
 Polished



14
Nero matt
 Matt black

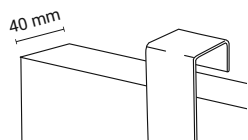

2123

L40 x P7,2 x H12,2 cm



2124

L40 x P5,4 x H13,6 cm

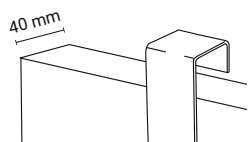
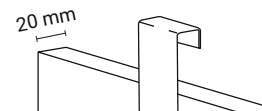

2125

L4,5 x P7,5 x H14 cm



2126

L3 x P4,6 x H11 cm

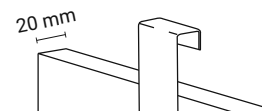

5626 Thor.

GEDY

Acciaio inox AISI 304

Stainless steel AISI 304
 Acier inoxydable AISI 304
 Edelstahl AISI 304
 Acero inox AISI 304
 нержавеющей сталь AISI 304



13
Cromato
 Chromed



14
Nero matt
 Matt black

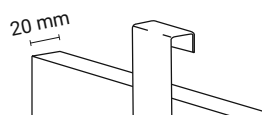

L2,1 x P4,5 x H7 cm



GARANZIA
 WARRANTY



Appendiabiti sopra porta - Over door clothes hooks.

2129 Tosca.

NEW

GEDY

15
YEARS

GARANZIA
WARRANTY

100 %
AISI
304

Porta salviette per sopra porta e mobile da bagno

Over door/bathroom unit hanging towel rack

Porte-serviettes pour dessus de porte et meuble de salle de bains

Handtuchhalter für Türen und Badmöbel

Toallero para puerta y mueble de baño

Полотенцедержатель для установки
на дверь и на тумбочку для раковины



Acciaio inox AISI 304

Stainless steel AISI 304

Acier inoxydable AISI 304

Edelstahl AISI 304

Acero inox AISI 304

нержавеющая сталь AISI 304



13
Cromato
Chromed



14
Nero matt
Matt black

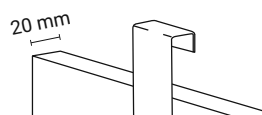

L30 x P6,9 x H4,7 cm

Porta phon

Hairdryer supports - Supports sèche-cheveux
Haartrocknerhalter - Soportes para secador de pelo
Держатель для фена



Eros.

RETAIL

Acciaio inox e Cromall®

Stainless steel and Cromall®

Acier inoxydable et Cromall®

Edelstahl und Cromall®

Acero inox y Cromall®

Нержавеющей стали и Cromall®



2355

L9,5 x P12,5 x H17 cm



GARANZIA
WARRANTY



13
Cromato
Chromed



14
Nero matt
Matt black



Con colla
With glue



Con viti
With screws

(Venduta a parte
Sold seperately)

5056.

GEDY

Acciaio inox e Cromall®

Stainless steel and Cromall®

Acier inoxydable et Cromall®

Edelstahl und Cromall®

Acero inox y Cromall®

Нержавеющей стали и Cromall®

10
YEARS

GARANZIA
WARRANTY



Gira la placca
come vuoi
Turn the plate



L10,6 x P16,3 x H18,2 cm

13
Cromato
Chromed



Con colla
With glue

(Venduta a parte
Sold seperately)



Con viti
With screws

5055.

GEDY

Acciaio inox e Cromall®

Stainless steel and Cromall®

Acier inoxydable et Cromall®

Edelstahl und Cromall®

Acero inox y Cromall®

Нержавеющей стали и Cromall®

10
YEARS

GARANZIA
WARRANTY

13
Cromato
Chromed



L10,6 x P16 x H17 cm



Con viti
With screws



Con colla
With glue

(Venduta a parte
Sold seperately)

13
Cromato
Chromed

38
Spazzolato
Brushed

NEW



Con biadesivo
With double
sided tape



Con viti
With screws



L10,4 x P13,8 x H8,1 cm

FJ55 Fuji.

GEDY

Acciaio inox AISI 304 e Cromall®

AISI 304 stainless steel and Cromall®

Acier inoxydable AISI 304 et Cromall®

Edelstahl AISI 304 und Cromall®

Acero inox AISI 304 y Cromall®

нержавеющей стали AISI 304 и Cromall®

AISI
304

15
YEARS

GARANZIA
WARRANTY



13
Cromato
Chromed



14
Nero matt
Matt black



Con biadesivo
With double
sided tape



Con viti
With screws



L10 x P14 x H7,3 cm

TE55 Teide.

GEDY

Acciaio inox e Cromall®
Stainless steel and Cromall®
Acier inoxydable et Cromall®
Edelstahl und Cromall®
Acero inox y Cromall®
Нержавеющей стали и Cromall®

10
YEARS

GARANZIA
WARRANTY

H052 Hot.

GEDY

Metallo e resine termoplastiche

Metal and thermoplastic resins
Métal et résine thermoplastique
Metall und Kunststoff
Metal y resinas termoplásticas
металл и термопластичные смолы

10
YEARS

GARANZIA
WARRANTY



L10,7 x P12 x H22 cm



13
Cromato
Chromed



Con ventosa
With suction cup



02
Bianco
White

100% MADE
in Italy



Con colla
With glue



Con viti
With screws

(Venduta a parte
Sold seperately)



L9,5 x P10,2 x H11,2 cm

5052-301.

GEDY

Resine termoplastiche
Thermoplastic resins
Résine thermoplastique
Kunststoff
Resinas termoplásticas
Термопластичные смолы

Sgabelli

Stools - Tabourets
Hocker - Taburetes
Табуреты



Prima Classe.

TOP DESIGN

design Studio Talocci Design & Pallocca

Alluminio e ABS

Aluminum and ABS
Aluminium et ABS
Aluminium und ABS
Aluminio y ABS
Алюминия и ABS



6073

L35,5 x P35,5 x H43 cm

Gambe cromate - Chromed legs



GARANZIA
WARRANTY

100% MADE
in Italy



02
Bianco
White



85
Antracite
Anthracite

COMPLEMENTI D'ARREDO. FURNISHING ACCESSORIES.

Yannis.

TOP DESIGN

design LucidiPevere



GARANZIA
WARRANTY

100% MADE
in Italy



Acciaio inox e resine termoplastiche

Stainless steel and thermoplastic resins

Acier inoxydable et thermoplastique

Edelstahl und Kunststoff

Acero inox y resinas termoplásticas

нержавеющая сталь и термопластичные смолы



02
Bianco
White



14
Nero
Black



As awarded by the Chicago
AthenAeum: Museum of Architecture
and design

2172

L37 x P33,7 x H43,5 cm

Sgabelli - Stools .

6072 Prima Classe.

GEDY

design Studio Talocci Design

Alluminio e ABS

Aluminum and ABS
Aluminium et ABS
Aluminium und ABS
Aluminio y ABS
Алюминия и ABS



L40,9 x P33,1 x H43,8 cm



02
Bianco
White



23
Bianco/Cromato
White/Chromed



43
Antracite/Cromato
Anthracite/Chromed

100% MADE
in Italy



02
Bianco
White



L49,5 x P39 x H40/58 cm



1072 Friend.

GEDY

Alluminio e polietilene

Aluminum and polythene
Aluminium et polythène
Aluminium und Polyäthylen
Aluminio y politeno
Алюминий и Полиэтилен

2872 Tetra.

GEDY

design Olaf Von Bohr

Resine termoplastiche

Thermoplastic resins
Résine thermoplastique
Kunststoff
Resinas termoplásticas
Термопластичные смолы



L42 x P27 x H41 cm



02
Bianco
White

100% MADE
in Italy



02
Bianco
White

100% MADE
in Italy



ø 33 x H40 cm

2072 Trio.

GEDY

Resine termoplastiche

Thermoplastic resins
Résine thermoplastique
Kunststoff
Resinas termoplásticas
Термопластичные смолы

Sgabelli richiudibili

Foldable stools - Tabourets repliables
Klapphockern - Taburetes plegable
Складные табуреты



98
Pero
Pear wood



ø 29,8 x H46 cm

C073.

GEDY

MDF e metallo

MDF and steel
MDF et métal
MDF und Metall
MDF и металла

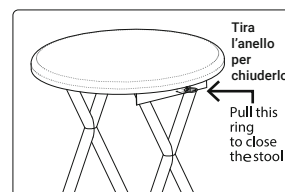

02
Bianco
White



05
Blu
Blue



67
Arancione
Orange



79
Lilla
Lilac



L30 x P29,3 x H46,5 cm

C075.

GEDY

Resine termoplastiche e metallo

Thermoplastic resins and steel
Résine thermoplastique et métal
Kunststoff und Metall
Resinas termoplásticas y metal
Термопластичных смол и металла

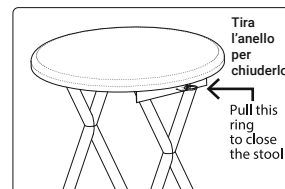



C076.

GEDY

Resine termoplastiche e metallo

Thermoplastic resins and steel

Résine thermoplastique et métal

Kunststoff und Metall

Resinas termoplásticas y metal

Термопластичных смол и металла

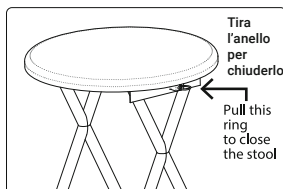

L30,5 x P27,5 x H46,5 cm



02
Bianco
White



08
Grigio
Grey



14
Nero
Black



52
Tortora
Turtledove
grey



66
Tortora chiaro
Light
turtledove
grey

Organizer

Organizers - Organiseurs
Veranstalters - Organizadores - Органайзер



Ilan.

NEW

GEDY

Bambù

Bamboo
Bambou
Bambus
Bambú
Бамбука

bamboom



35
Naturale
Natural



Natural



Save
the planet



Bambù
Bamboo



IA06

L34 x P23 x H1,8 cm

Lavanda.

GEDY

Rafia e nylon

Raffia and nylon
Raphia et nylon
Bast und Nylon
Rafia y nylon
Рафии и нейлона



LA06

L31 x P19 x H16,5 cm



LA07

L21 x P15 x H12 cm



08
Grigio
Grey



29
Moka



02
Bianco
trasparente
Transparent
white



04
Verde acido
trasparente
Transparent
acid green



05
Blu
trasparente
Transparent
blue



06
Rosso
trasparente
Transparent
red



14
Nero
trasparente
Transparent
black



52
Tortora
trasparente
Transparent
turtledove grey



66
Tortora chiaro
trasparente
Transparent light
turtledove grey



67
Arancione
trasparente
Transparent
orange



73
Argento
trasparente
Transparent
silver



79
Lilla
trasparente
Transparent
lilac



L19 x P11 x H7,5 cm

RA00 Rainbow.

GEDY

Resine termoplastiche

Thermoplastic resins
Résine thermoplastique
Kunststoff
Resinas termoplásticas
Термопластичные смолы



00
Trasparente
Transparent

100% MADE
in Italy



L18,8 x P10,7 x H7,5 cm

GL00 Gladly.

GEDY

Resine termoplastiche

Thermoplastic resins
Résine thermoplastique
Kunststoff
Resinas termoplásticas
Термопластичные смолы



Seventy.

GEDY

design Makio Hasuike

Resine termoplastiche

Thermoplastic resins
Résine thermoplastique
Kunststoff
Resinas termoplásticas
Термопластичные смолы



22
Bianco
White



66
Beige
Beige



6301

L25 x P28 x H7,1 cm

100% MADE
in Italy





Seventy.

GEDY

design R&S Gedy

Resine termoplastiche

Thermoplastic resins
Résine thermoplastique
Kunststoff
Resinas termoplásticas
Термопластичные смолы



08
Grigio
Grey



22
Bianco
White



27
Acquamarina
Aquamarine



52
Tortora
Turtledove
grey



65
Blu petrolio
Petrol blue



66
Beige
Beige



86
Celeste
Sky blue

100% MADE
in Italy



6300

L11,6 x P11,6 x H12,1 cm



6305

L5,5 x P5,5 x H11 cm

Seventy.

GEDY

100% MADE
in Italy



22
Bianco
White



Resine termoplastiche

Thermoplastic resins
Résine thermoplastique
Kunststoff
Resinas termoplásticas
Термопластичные смолы

6306

L27 x P13,6 x H2,2 cm

NEW



Resine termoplastiche

Thermoplastic resins
Résine thermoplastique
Kunststoff
Resinas termoplásticas
Термопластичные смолы

6302

L20x P12 x H6,4 cm

NEW

Portabiancheria

Laundry baskets - Coffres à linge - Wäschebehälter
Cestos de ropa - Корзина для грязного белья

Yoshi.

GEDY

 bamboom



05
Blu
Blue



08
Grigio
Grey

Bambù e poliestere

Bamboo and polyester
Bambou et polyester
Bambus und polyester
Bambú y poliéster
Бамбука и Полиэстер



Natural



Save
the planet



Bambù
Bamboo



1338 - 87 lt

L53 x P34 x H51 cm

2038 Ambrogio.

GEDY

Resine termoplastiche

Thermoplastic resins
Résine thermoplastique
Kunststoff
Resinas termoplásticas
Термопластичные смолы



L50 x P28 x H55 cm - 70 lt



02
Bianco
White



03
Beige
Beige



05
Blu
Blue



08
Grigio
Grey



08
Grigio
Grey



29
Moka



L35 x P35 x H58 cm - 70 lt

LA38 Lavanda.

GEDY

Rafia e nylon

Raffia and nylon
Raphia et nylon
Bast und Nylon
Rafia y nylon
Рафии и нейлона



03
Ecrù
Ecrù



L34 x P15 x H60 cm - 30 lt

BY38 Baggy.

GEDY

Tessuto (cotone 70%, poliestere 30%)

Fabric (cotton 70%, polyester 30%)
Tissu (coton 70%, polyester 30%)
Stoff (Baumwolle 70%, Polyester 30%)
Tela (algodón 70%, poliéster 30%)
Ткани (хлопок 70%, полиэстер 30%)

C038 Laundry.

GEDY

Tessuto (cotone 35%, poliestere 65%) e metallo

Fabric (cotton 35%, polyester 65%) and metal
Tissu (coton 35%, polyester 65%) et métal
Stoff (Baumwolle 35%, Polyester 65%) und Metall
Tela (algodón 35%, poliéster 65%) y metal
Ткани (хлопок 35%, полиэстер 65%) и металла



03
Ecrù
Ecrù



11
Azzurro
Light blue

ø 38 x H58 cm - 69 lt

Tatami.

bamboom

GEDY



02
Bianco
White



14
Nero
Black



Natural



Save
the planet



Bambù
Bamboo



Bambù e cotone

Bamboo and cotton
Bambou y coton
Bambus und Baumwolle
Bambú y algodón
Бамбука и хлопок

Sacchetto interno estraibile e lavabile per la massima igiene
Fully removable and washable sack inside for maximum hygiene
Sachet intérieur extractible et lavable pour le maximum d'hygiène
Wäschebeutel, Innenteil abnehmbar und waschbar für maximale Hygiene
Bolsita interna extraíble y lavable para la máxima higiene
В целях гигиены внутренний пакет можно извлечь и помыть



TA38

L35,5 x P35,5 x H63 cm - 68 lt

Mensole

Shelves - étagères - Ablagen
Estantes - Полочки

Artemis.

100% MADE
in Italy



GEDY

Vetro Ultralight 6 mm e Cromall®

6 mm Ultralight glass and Cromall® - Verre Ultralight 6 mm et Cromall® - 6 mm Ultralight Glas und Cromall®
Cristal Ultralight 6 mm y Cromall® - Стекла Ultralight 6 mm и Cromall®



2119-24

L24 x P24 x H2 cm

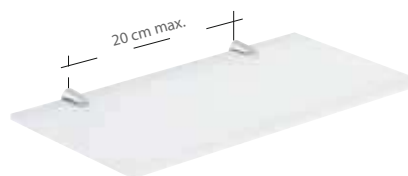

2119-30

L30 x P16,5 x H2 cm

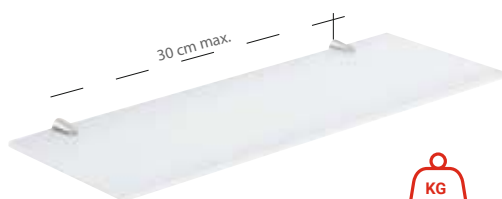

2119-45

L45 x P16,5 x H2 cm



2119-60

L60 x P16,5 x H2 cm

Ilios.

GEDY

Cromall® e vetro temperato

Cromall® and tempered glass
Cromall® et verre temperé
Cromall® und Sekuritglas
Cromall® y cristal templado
Cromall® и закаленное стекло



Peso
uniformemente
distribuito

Weight evenly
distributed

Gira la placca
come vuoi
Turn the plate

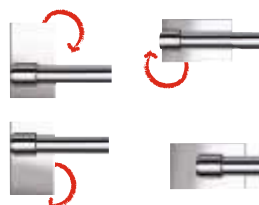

13
Cromato
Chromed



2219-60

L58 x P11,6 x H6 cm

Bilancie elettroniche

Electronic scales - Balances électronique - Elektronische Waagen
Básculas electrónica - Весы электронные напольные

Crystal.

GEDY



02
Bianco
White



14
Nero
Black



CY90

L28 x P28 x H2,5 cm



Realizzata in vetro e resine termoplastiche

Made in glass and thermoplastic resins - Réalisé en verre et résine thermoplastique - Hergestellt aus Glas und Kunststoff
Realizada en cristal y resinas termoplásticas - Изготовлено из стекла и термопластичных смол

Rainbow.

GEDY



04
Verde acido
Acid green



05
Blu
Blue



67
Arancio
Orange

Realizzata in vetro, resine termoplastiche e metallo

Made in glass, thermoplastic resins and metal - Réalisé en verre, résine thermoplastique et métal
Hergestellt aus Glas, Kunststoff und Metall - Realizada en cristal, resinas termoplásticas y metal
Изготовлено из стекла, термопластичных смол и металла



RA90

L34 x P27,4 x H2,7 cm



ACCESSORI DOCCIA

Shower accessories

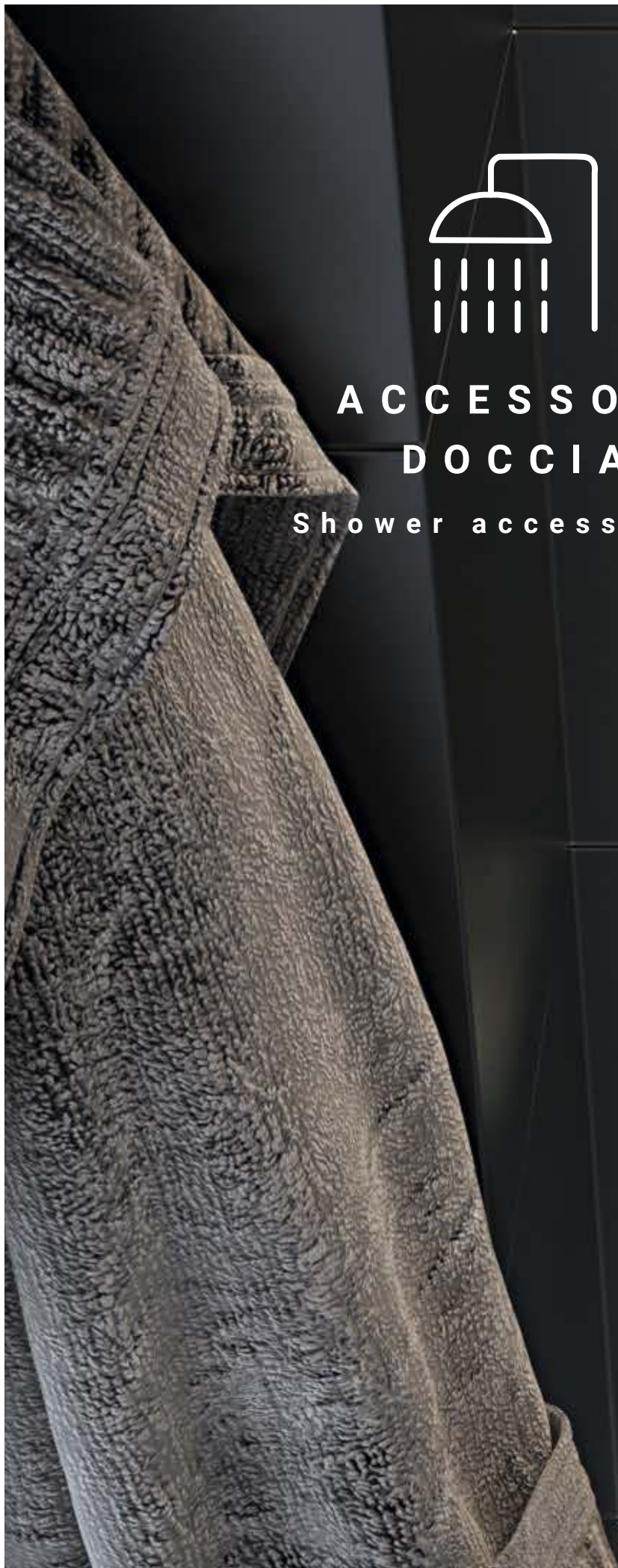



Porta oggetti doccia

Shower caddies - Porte-objets pour douche
Duschablage - Portaobjetos para ducha - Полочки для душа

15
YEARS

GARANZIA
WARRANTY

AISI
304



13
Cromato
Chromed

Il Giglio.

NEW

TOP DESIGN

design Makio Hasuike

Acciaio inox AISI 304 e Cromall®

Stainless steel AISI 304 and Cromall®

Acier inoxydable AISI 304 et Cromall®

Edelstahl AISI 304 und Cromall®

Acero inoxidable AISI 304 y Cromall®

Нержавеющая сталь AISI 304 и Cromall®



A918

L40 x P11,5 x H4,2 cm



A983

L25,5 x P25,5 x H4,2 cm



A919

L25 x P21,5 x H4,2 cm

Porta oggetti doccia - Shower caddies .

Tobago.

TOP DESIGN

Acciaio inox AISI 304, ottone e Cromall®

Chromed AISI 304 stainless steel,
brass and Cromall®

Acier inoxydable AISI 304,
laiton et Cromall®

Verchromtem Edelstahl AISI 304,
Messing und Cromall®

Acero inox AISI 304, latón y Cromall®

Нержавеющей стали AISI 304

и латуни и Cromall®

15
YEARS

GARANZIA
WARRANTY



Igiene facile
Easy clean

AISI
304



13
Cromato
Chromed



S118

L26,3 x P12,7 x H7,2 cm



S180

L19,6 x P19,6 x H7,2 cm

15
YEARS

GARANZIA
WARRANTY

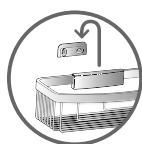

Igiene facile
Easy clean



13
Cromato
Chromed



S283

L19 x P19 x H7,8 cm



S280

L19 x P19 x H5,8 cm

Barbados.

TOP DESIGN

Ottone e Cromall®

Brass and Cromall®

Laiton et Cromall®

Messing und Cromall®

Latón y Cromall®

Латуни и Cromall®

Zante.

TOP DESIGN

design Piet Billekens

ABS e Cromall®

ABS and Cromall®

ABS et Cromall®

ABS und Cromall®

ABS y Cromall®

ABS и Cromall®

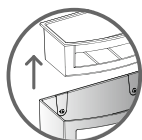

Igiene facile
Easy clean



23
Cromato/Bianco
Chromed/White



43
Cromato/Nero
Chromed/Black



A718

L24,2 x P11,6 x H7,3 cm



15
YEARS

GARANZIA
WARRANTY



A780

L19,1 x P19,1 x H7,3 cm



Lounge.

TOP DESIGN

Ottone e alluminio

Brass and aluminum
Laiton et aluminium
Messing und Aluminium
Latón y aluminio
Латуни и алюминий

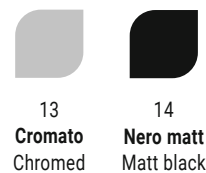

5412

L14 x P11 x H2,5 cm



5418

L24,6 x P13,7 x H2,5 cm



GARANZIA
WARRANTY



Outline.

TOP DESIGN

design Simone Micheli

Acciaio inox AISI 304 e Cromall®

Stainless steel AISI 304 and Cromall®
Acier inoxydable AISI 304 et Cromall®
Edelstahl AISI 304 und Cromall®
Acero inox AISI 304 y Cromall®
Нержавеющая сталь AISI 304 и Cromall®

AISI
304



GARANZIA
WARRANTY



3218

L24 x P11 x H3 cm



3283

L16,9 x P16,9 x H3 cm



13
Cromato
Chromed



100%
AISI
304



GARANZIA
WARRANTY

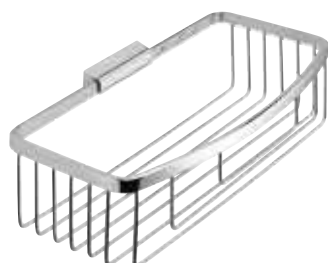

S018

L26 x P13 x H7,5 cm



S080

L19,5 x P19,5 x H7,5 cm

Trinidad.

TOP DESIGN

Acciaio inox AISI 304

Stainless steel AISI 304
Acier inoxydable AISI 304
Edelstahl AISI 304
Acero inox AISI 304
Нержавеющая сталь AISI 304

Haiti.

TOP DESIGN

Ottone

Brass
Laiton
Messing
Latón
латуни



GARANZIA
WARRANTY



13
Cromato
Chromed



A782

L24 x P17,5 x H63 cm



Apollo.

15
YEARS

RETAIL

GARANZIA
WARRANTY

Ottone

Brass
Laiton
Messing
Latón
Латунь



13
Cromato
Chromed

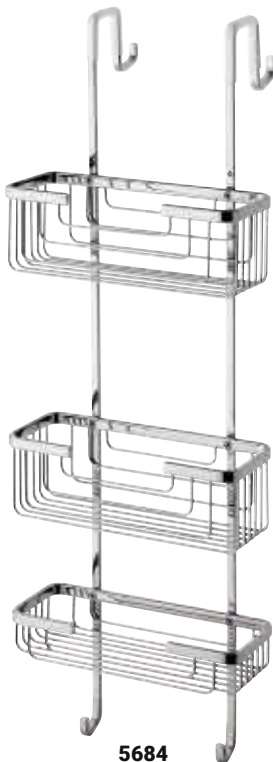

5684

L25 x P18,8 x H72,5 cm



5683

L24,5 x P18,5 x H55 cm

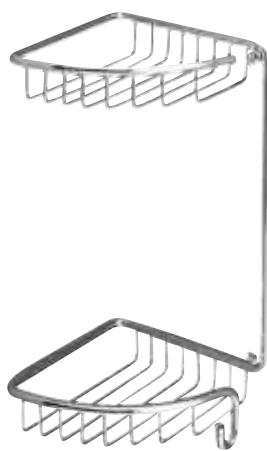

5681

L17,3 x P17,3 x H34,5 cm



5618

L33 x P13 x H7 cm

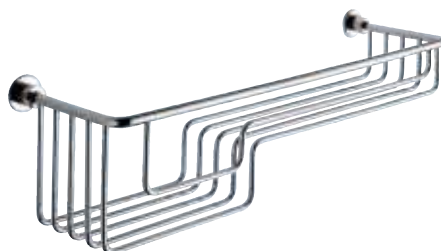

5620

L42,5 x P13 x H11,5 cm

Poseidon.

RETAIL

Acciaio inox AISI 304 e ABS

Stainless steel AISI 304 and ABS

Acier inoxydable AISI 304 et ABS

Edelstahl AISI 304 und ABS

Acero inox AISI 304 y ABS

Нержавеющая сталь AISI 304 и ABS



13
Lucido
Polished



23
Bianco/Lucido
White/Polished



43
Nero/Lucido
Black/Polished



GARANZIA
WARRANTY

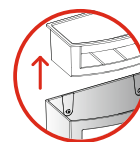

Igiene facile
Easy clean



7718

L24 x P12,3 x H7,2 cm



7780

L19,8 x P19,8 x H7,2 cm



Poseidon.

RETAIL

Acciaio inox AISI 304 e ABS

Stainless steel AISI 304 and ABS

Acier inoxydable AISI 304 et ABS

Edelstahl AISI 304 und ABS

Acero inox AISI 304 y ABS

Нержавеющая сталь AISI 304 и ABS



13
Lucido
Polished



23
Bianco/Lucido
White/Polished



43
Nero/Lucido
Black/Polished

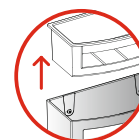

Igiene facile
Easy clean



7719

L24 x P18,7 x H58,4 cm



Cloud.

GEDY

Alluminio anodizzato e vetro temperato

Anodised aluminium and tempered glass

Aluminium anodisé et verre tempéré

Eloxiertes Aluminium und Sekuritglas

Aluminio anodizado y cristal templado

анодированный алюминий и закаленного стекла



Con colla
With glue

(Venduta a parte
Sold seperately)



Con viti
With screws



38
Spazzolato
Brushed



GARANZIA
WARRANTY



CD18

L30 x P14,6 x H5,8 cm



CD82

L30 x P14,6 x H30 cm



CD80

L26 x P26 x H5,8 cm



CD81

L26 x P26 x H30 cm



Augustus.

GEDY

Acciaio inox

Stainless steel

Acier inoxydable

Edelstahl

Acero inox

Нержавеющей стали

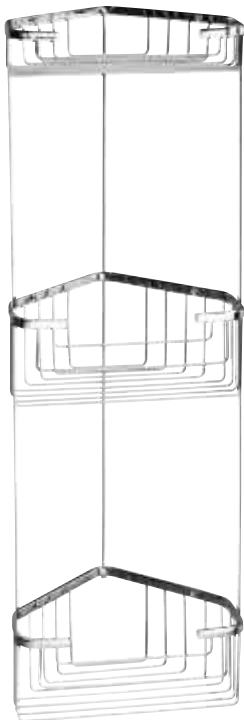

2484

L17,2 x P17,2 x H61,5 cm



13

Cromato
Chromed



2482

L20 x P15,1 x H32,5 cm



14

Nero matt
Matt black



13

Cromato
Chromed



2481

L20 x P15 x H27 cm



13

Cromato
Chromed



14

Nero matt
Matt black

Tito.

GEDY

Metallo

Metal - Métal - Metall

Metal - Металла



13
Cromato
Chromed



2485

L24 x P22 x H49 cm



2486

L24 x P22 x H68 cm



2487

L24 x P22 x H49 cm



2488

L24 x P22 x H68 cm



Augustus.

GEDY

design Carlo Vietri *

Acciaio inox

Stainless steel

Acier inoxydable

Edelstahl

Acero inox

Нержавеющей стали



13
Cromato
Chromed



2418 *

L25 x P9,6 x H3,5 cm



2480 *

L19,3 x P19,3 x H3,5 cm

13
Cromato
Chromed



2411 *

L12,5 x P10 x H3,5 cm



02
Bianco
White



13
Cromato
Chromed



14
Nero matt
Matt black



2419

L25,2 x P10,2 x H8,6 cm



02
Bianco
White



13
Cromato
Chromed



14
Nero matt
Matt black



44
Bronzo
Bronze

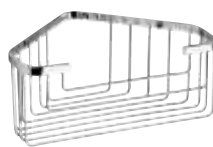

2483

L20 x P15,1 x H8 cm

Kit 2 placche

Pack of 2 plates - Kit 2 plaques

Packung mit 2 Wandplatten

Caja de 2 placas de pared

Набор из 2 пластин

Cromall®

Utilizzabili con i seguenti angolari

Can be mounted with - Peut être monté avec - Montierbar mit

Pueden montarse con - Может устанавливаться с:

2418 - 2419 - 2480 - 2481 - 2482 - 2483 - 2484



2405

L6 x P1,7 x H3,8 cm



Con biadesivo
With double
sided tape



13
Cromato
Chromed

ES80 Essential.

GEDY

Acciaio inox AISI 304 e ABS

Stainless steel AISI 304 and ABS

Acier inoxydable AISI 304 et ABS

Edelstahl AISI 304 und ABS

Acero inox AISI 304 y ABS

Нержавеющая сталь AISI 304 и ABS

AISI
304



L17,8 x P17,8 x H4,9 cm



13
Cromato
Chromed



GARANZIA
WARRANTY

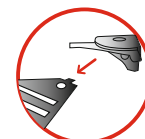

Igiene facile
Easy clean

Hot.

GEDY

Metallo e resine termoplastiche

Metal and thermoplastic resins

Métal et thermoplastique

Metall und Kunststoff

Metal y resinas termoplásticas

металла и термопластичных смол



13
Cromato
Chromed



14
Nero
Black



H018

L26,2 x P15,7 x H17 cm



H019

L27,4 x P12,5 x H35,5 cm



H020

L27,5 x P13,6 x H12 cm



H080

L19 x P19 x H10 cm



Con ventosa
With suction cup

Solo su superfici lisce
(specchi, piastrelle)
For flat surfaces
(mirrors, tiles) only

Nerva.

GEDY

100%
AISI
304



13
Lucido
Polished



14
Nero matt
Matt black



38
Spazzolato
Brushed



GARANZIA
WARRANTY

Acciaio inox AISI 304

Stainless steel AISI 304

Acier inoxydable AISI 304

Edelstahl AISI 304

Acero inox AISI 304

Нержавеющая сталь AISI 304



2417

L30 x P12,8 x H4,5 cm



2479

L21 x P21 x H4,5 cm



CP80 Clip.

GEDY

ABS



Igiene facile
Easy clean



L23 x P23 x H7,5 cm



02
Bianco
White



13
Cromato
Chromed



13
Cromato
Chromed



Con viti
With screws



Con colla
With glue

(Venduta a parte
Sold seperately)

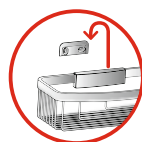

Igiene facile
Easy clean



2416

L24 x P12,6 x H6,6 cm



2478

L19,5 x P19,5 x H6,6 cm

Tiberio.

GEDY

design Leo De Carlo

Resine termoplastiche

Thermoplastic resins

Résine thermoplastique

Kunststoff

Resinas termoplásticas

Термопластичные смолы

FL80 Fluor.

GEDY

ABS



L23 x P23 x H3 cm



13
Cromato
Chromed

Caesar.

GEDY

Resine termoplastiche e acciaio inox

Thermoplastic resins and stainless steel

Thermoplastique et acier inoxydable

Kunststoff und Edelstahl

Resinas termoplásticas y acero inox

термопластичных смол

и нержавеющей стали



02
Bianco
White



08
Grigio
Grey



52
Tortora
Turtledove
grey



7080

L22,6 x P16 x H47,3 cm



7081

L22,6 x P16 x H71 cm



02
Bianco
White



52
Tortora
Turtledove
grey

100% MADE
in Italy



8081 Junior.

GEDY

Resine termoplastiche

Thermoplastic resins
 Résine thermoplastique
 Kunststoff
 Resinas termoplásticas
 Термопластичные смолы



L22 x P12 x H47 cm

100% MADE
 in Italy



02
 Bianco
 White



02
 Bianco
 White

100% MADE
 in Italy



L22 x P14 x H38 cm

8079 Junior.

GEDY

Resine termoplastiche

Thermoplastic resins
 Résine thermoplastique
 Kunststoff
 Resinas termoplásticas
 Термопластичные смолы

8579 Oscar.

GEDY

Resine termoplastiche

Thermoplastic resins
 Résine thermoplastique
 Kunststoff
 Resinas termoplásticas
 Термопластичные смолы



L23x P23 x H37,3 cm

100% MADE
 in Italy



02
 Bianco
 White



08
 Grigio
 Grey



52
 Tortora
 Turtledove
 grey



Con viti
 With screws



Con silicone
 With silicon



Con biadesivo
 With double
 sided tape



Con viti
 With screws



Con ventosa
 With suction cup

Solo su superfici lisce
 (specchi, piastrelle)
 For flat surfaces
 (mirrors, tiles) only



02
 Bianco
 White

100% MADE
 in Italy



8080 Junior.

GEDY

design Gianpietro Tonetti

Resine termoplastiche

Thermoplastic resins
 Résine thermoplastique
 Kunststoff
 Resinas termoplásticas
 Термопластичные смолы

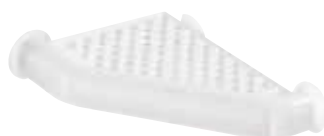

L19,6 x P15,6 x H3 cm

Nature.

bamboom



35
Naturale
Natural

GEDY

Bambù

Bamboo
Bambou
Bambus
Bambú
Бамбука



Natural



Save
the planet



Bambù
Bamboo



2490

L27 x P12 x H61 cm



Tergivetro

Wiper-blades - Raclette de douche
Glasabzieher - Limpiacristales - Стеклоочиститель

S041 Egadi.

TOP DESIGN

Acciaio inox

Stainless steel
Acier inoxydable
Edelstahl
Acero inox
Нержавеющая сталь



L24 x P2,1 x H17,5 cm



13
Cromato
Chromed



13
Cromato
Chromed

S026 Egadi.

TOP DESIGN

Gancio per tergovetro S041/5641 con riduttori per adattamento vetri doccia

Hook for S041/5641 wiper-blade with adjusters for shower box glass
Crochet pour S041/5641 raclette de douche avec réducteurs pour adaptation des vitres de la douche
Haken für S041/5641 Glasabzieher mit Verjüngung zur Angleichung der Scheiben der Dusche
Percha para S041/5641 limpiacristales con reductores para adaptación cristales ducha
Крючок для S041/5641 со сабо для душевой кабины



S026

L4 x P4,5 x H8 cm

Acciaio inox

Stainless steel
Acier inoxydable
Edelstahl
Acero inox
Нержавеющая сталь

S027 Egadi.

TOP DESIGN

Gancio per tergovetro per S041/5641

Crochet pour S041/5641 raclette de douche
Haken für S041/5641 Glasabzieher
Percha para S041/5641 limpiacristales
Крючок для S041/5641

Acciaio inox

Stainless steel - Acier inoxydable
Edelstahl - Acero inox - Нержавеющая сталь



L4 x P2,7 x H5,5 cm



13
Cromato
Chromed



Con biadesivo
With double
sided tape

Thor.

GEDY



13
Cromato
Chromed



14
Nero matt
Matt black



5641

L26 x P2,5 x H17 cm

Ottone

Brass - Laiton - Messing - Latón - Латуни



100%
AISI
304

5626

L2,1 x P4,5 x H7 cm

Acciaio inox AISI 304

Stainless steel AISI 304
Acier inoxydable AISI 304
Edelstahl AISI 304
Acero inox AISI 304
Нержавеющая сталь AISI 304



AISI
304



5699

L26 x P4,5 x H24 cm

Ottone e acciaio inox AISI 304

Brass and stainless steel AISI 304
Laiton et acier inoxydable AISI 304
Messing und Edelstahl AISI 304
Latón y acero inox AISI 304
Латуни и нержавеющая сталь AISI 304





Gummy.

GEDY

Resine termoplastiche

Thermoplastic resins
Résine thermoplastique
Kunststoff
Resinas termoplásticas
Термопластичных смол



2641

L22 x P3 x H23 cm



02
Bianco
White



08
Grigio
Grey



14
Nero matt
Matt black



66
Tortora chiaro
Light turtledove
grey



Con ventosa
With suction cup

Tappeti antiscivolo

Non slip mats - Tapis anti dérapants
Rutsch sichere Matten - Alfombras antideslizantes
Антискользящие коврики

GEDY

PVC plasticato

Plasticized PVC - PVC plastifié - Kunststoffbeschichtetes PVC
PVC plastificado - ПВХ Пластмасса



00

Trasparente
Transparent

100% MADE
in Italy



PER DOCCIA
FOR SHOWER



975858

L60 x P60 x H0,6 cm



976060

L60 x P60 x H0,6 cm



PER DOCCIA
FOR SHOWER



PER DOCCIA
FOR SHOWER



978060

L80 x P60 x H0,6 cm



PER VASCA
FOR BATHTUB

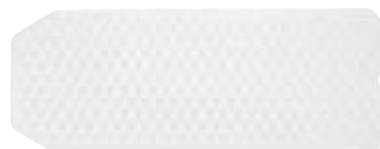

971040

L104 x P40 x H0,6 cm



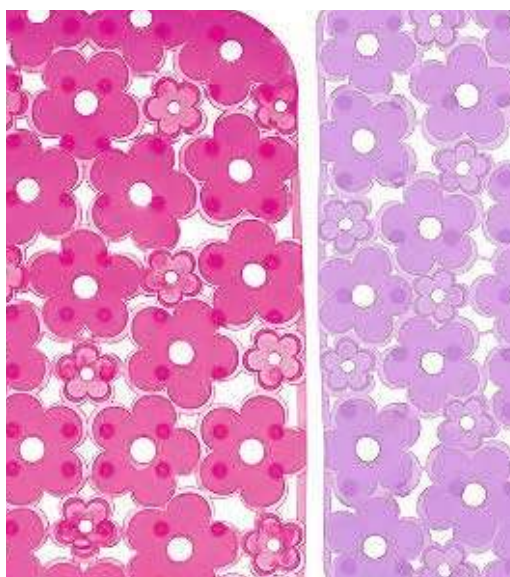

Margherita.

GEDY

PVC



PER DOCCIA
FOR SHOWER



975151

L51,5 x P51,5 x H0,7 cm



PER VASCA
FOR BATHTUB



973572

L72 x P34,5 x H0,7 cm

100% MADE
in Italy



P0
Fucsia
Fuxia



P1
Azzurro
Light blue



P2
Trasparente
Transparent



P4
Arancione
Orange



P9
Lilla
Lilac



00

Trasparente
Transparent

Duck.

GEDY

PVC

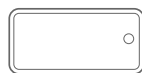

PER VASCA
FOR BATHTUB



TAVA403

L77 x P37 x H0,7 cm



River.

GEDY

PVC



TADO401

L54 x P54 x H0,7 cm



PER DOCCIA
FOR SHOWER



00
Trasparente
Transparent



08
Grigio
Grey



TAVA401

L70 x P35 x H0,7 cm



PER VASCA
FOR BATHTUB

Tappeti antiscivolo - Non slip mats.



Solid.

GEDY

PVC



PER DOCCIA
FOR SHOWER

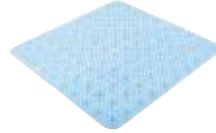

TADO400

L53 x P53 x H0,7 cm



PER VASCA
FOR BATHTUB



TAVA400

L69 x P38,5 x H0,7 cm



00

Trasparente
Transparent



02

Bianco
White



P1

Azzurro
trasparente
Transparent
light blue



P8

Verde
trasparente
Transparent
green



00

Trasparente
Transparent



02

Bianco
White



P1

Azzurro
trasparente
Transparent
light blue



TADO402

L53 x P50 x H0,4 cm

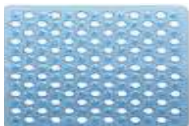

TAVA402

L60 x P38 x H0,4 cm



PER DOCCIA
FOR SHOWER



PER VASCA
FOR BATHTUB

Maim.

GEDY

PVC



Pietra.

GEDY

Vinile

Vinyl
Vinyl
Vinyl
Vinilo
Винила



C05656

L53,5 x P53,5 x H1 cm



C03475

L38 x P74,5 x H1 cm



PER DOCCIA
FOR SHOWER



PER VASCA
FOR BATHTUB



02

Bianco
White



08

Grigio
Grey



85

Antracite
Anthracite



Cuore.

GEDY

Vinile

Vinyl
Vinyl
Vinyl
Vinilo
Винила



PER DOCCIA
FOR SHOWER

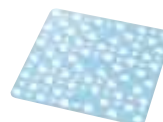

C05555

L53 x P53 x H0,6 cm



PER VASCA
FOR BATHTUB



C03675

L35,5 x P71,5 x H0,6 cm



00
Trasparente
Transparent



11
Azzurro
Light blue



02
Bianco
White



08
Grigio
Grey



14
Nero
Black



66
Tortora chiaro
Light
turtledove grey



985555

L54,5 x P54,5 x H0,5 cm



983979

L79 x P39,5 x H0,5 cm



PER DOCCIA
FOR SHOWER

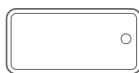

PER VASCA
FOR BATHTUB

Giotto.

GEDY

Gomma

Rubber
Cautchouc
Gummi
Goma
Каучука



100% MADE
in **Italy**

985353. 983672.

GEDY

Gomma

Rubber
Cautchouc
Gummi
Goma
Каучука



985353

L52,5 x P52,5 x H0,6 cm



983672

L71 x P36 x H0,6 cm



PER DOCCIA
FOR SHOWER



PER VASCA
FOR BATHTUB



02
Bianco
White

100% MADE
in **Italy**

Tappeti antiscivolo - Non slip mats.



Geo.

GEDY

Gomma

Rubber
Cautchouc
Gummi
Goma
Качука

100% MADE
in Italy



02
Bianco
White



03
Beige
Beige



PER DOCCIA
FOR SHOWER



975353

L51,5 x P51,5 x H0,6 cm



PER VASCA
FOR BATHTUB



973671

L35 x P68 x H0,6 cm



11
Azzurro
Light blue



67
Arancione
Orange

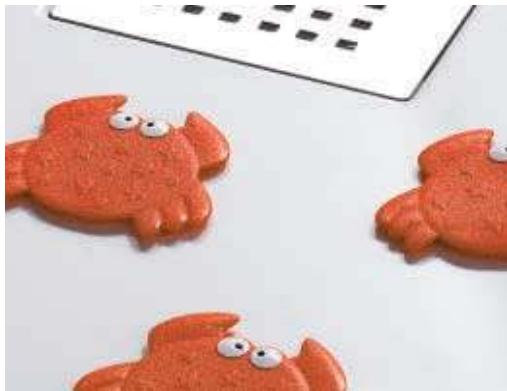

06
Rosso
Red

Crabby.

GEDY

PVC



TANP404

L11,3 x P9 x H0,6 cm
4pz/pcs



Daisy.

GEDY

PVC



10
Rosa
Pink



TANP405

L12,5 x P12 x H0,5 cm
4pz/pcs



09
Giallo
Yellow

Duffy.

GEDY

PVC



TANP406

L10 x P12 x H0,5 cm
4pz/pcs

Tappetini antiscivolo lavello

Sink-Mats - Tapis évier
Spülbeckenmatten
Alfombrilla lavabo
коврик для раковины

Stamp.

100% MADE
in Italy

GEDY



PVC



00

Trasparente
Transparent



02

Bianco
White



TALA501

L29 x P29 x H0,4 cm



TALA502

L29,2 x P38 x H0,4 cm



TALA503

ø 29 x H0,4 cm



00

Trasparente
Transparent



08

Grigio
Grey



TALA504

L26 x P26 x H0,3 cm

Lapis.

GEDY

PVC

Soap.

GEDY

Polietilene

Polyethylene

Polyéthylène

Polyethylen

Polietileno

Полиэтилен

100% MADE
in Italy



04

Verde acido
Acid green



05

Blu
Blue



TALA500

L32 x P32 x H0,3 cm



66

Tortora chiaro
Light
turtledove grey



73

Argento
Silver



02
Bianco
White



08
Grigio
Grey



Bricks.

GEDY

PVC

TALA505

L26 x P26 x H0,3 cm

Pedane doccia

Shower platforms - Caillebotis
Duschroste - Tarimas para ducha
Решетки для душа

Lido.

GEDY

Resine termoplastiche

Thermoplastic resins

Thermoplastique

Kunststoff

Resinas termoplásticas

Термопластичные смолы



02
Bianco
White



P1
Azzurro
Light blue

100% MADE
in Italy



Con piedini in gomma antiscivolo

With non-slip rubber feet

Avec des pieds en caoutchouc antidérapants

Mit rutschfesten Gummifüßen

Con pies de goma antideslizantes

С опорными ножками из нескользящей резины

C083

L58,2 x P57,5 x H3 cm



02
Bianco
White



08
Grigio
Grey

100% MADE
in Italy



Spirale.

GEDY

Resine termoplastiche

Thermoplastic resins

Thermoplastique

Kunststoff

Resinas termoplásticas

Термопластичные смолы

52

Tortora

Turtledove grey

8083

L54,5 x P54,5 x H2,2 cm

Sedili per doccia e vasca

Shower and bath tub seats - Sièges pour douche et baignoire
Dusch- und Badewannensitze - Asientos para ducha y bañera
Сидение в душ и ванну



Prima Classe.

TOP DESIGN

design Studio Talocci Design

Alluminio e ABS

Aluminum and ABS
Aluminium et ABS
Aluminium und ABS
Aluminio y ABS
Алюминий и АБС



Chiusura soft
Soft close

100% MADE
in Italy



02
Bianco
White



85
Antracite
Anthracite



6082

L35,7 x P37 x H13 cm

10
YEARS

GARANZIA
WARRANTY

Sit-in.

TOP DESIGN

Legno, alluminio e ABS

Wood, aluminium and ABS
Bois, aluminium et ABS
Holz, Aluminium und ABS
Madera, aluminio y ABS
Дерево, алюминий и ABS



4893

L48,9 x P33 x H10,5 cm

100% MADE
in Italy



98
Iroko
Iroko



GARANZIA
WARRANTY



100% MADE
in Italy



02

Bianco
White



23

Bianco/Cromato
White/Chromed



43

Antracite/Cromato
Anthracite/Chromed



— 4,8 —

6083

L35,5 x P37 x H10,5 cm

Prima Classe.

GEDY

design Studio Talocci Design

Alluminio e ABS

Aluminum and ABS
Aluminium et ABS
Aluminium und ABS
Aluminio y ABS
Алюминий и АБС



Chiusura soft
Soft close

GARANZIA
WARRANTY

Tip Up.

GEDY

Alluminio e ABS

Aluminum and ABS
Aluminium et ABS
Aluminium und ABS
Aluminio y ABS
Алюминий и АБС



100% MADE
in Italy



02
Bianco
White



85
Antracite
Anthracite



2182

L32,5 x P33 x H7,5 cm

ACCESSORI DOCCIA . SHOWER ACCESSORIES

Sicura.

GEDY

Resine termoplastiche e alluminio

Thermoplastic resins and aluminum
Thermoplastique et aluminium
Kunststoff und Aluminium
Resinas termoplásticas y aluminio
Термопластичных смол и алюминия



2284

L64x P32,4 x H18,3 cm



100% MADE
in Italy



02
Bianco
White



Regolabile
Adjustable



GARANZIA
WARRANTY

Braccioli estensibili per vasche con misura interna di 50-65 cm - Extendable arms for bathtubs with internal measurement 50-60 cm
Bras extensibles pour baignoires aux dimensions intérieures de 50-60 cm - Verlängerbare Armlehnen für Wannen mit einem Innenmaß von 50-60 cm - Apoyabrazos extensibles para bañeras con medidas interiores de 50-60 cm - Выдвижные поручни для ванны, имеющей внутреннюю ширину от 50 до 60 см

Sicura.

GEDY

Resine termoplastiche e alluminio

Thermoplastic resins and aluminum
Thermoplastique et aluminium
Kunststoff und Aluminium
Resinas termoplásticas y aluminio
Термопластичных смол и алюминия



2283

L34,5 x P34,5 x H10,5 cm



100% MADE
in Italy



02
Bianco
White



GARANZIA
WARRANTY

Sound.

GEDY

Resine termoplastiche e acciaio

Thermoplastic resins and steel
Thermoplastique et acier
Kunststoff und Stahl
Resinas termoplásticas y acero
термопластичных смол и стали



2282

L38,5 x P35,4 x H15,2 cm



02
Bianco
White



23
Bianco/Cromato
White/Chromed



100% MADE
in Italy



TEST CONDOTTI DALL'ISTITUTO
DI CERTIFICAZIONE QUALITÀ CABIATE (CO)
TESTED BY ISTITUTO DI CERTIFICAZIONE
QUALITÀ CABIATE (CO)

EN1728:2012+AC:2013



02
Bianco
White



D182

L37,5 x P29,5 x H7 cm

Dino.

GEDY

Resine termoplastiche

Thermoplastic resins
Thermoplastique
Kunststoff
Resinas termoplásticas
Термопластичные смолы

TEST CONDOTTI DALL'ISTITUTO
DI CERTIFICAZIONE QUALITÀ CABIATE (CO)
TESTED BY ISTITUTO DI CERTIFICAZIONE
QUALITÀ CABIATE (CO)



Friend.

GEDY

Alluminio e polietilene

Aluminum and polyethylene

Aluminium et polyéthylène

Aluminium und Polyethylen

Aluminio y polietileno

Алюминия и полиэтилен



02
Bianco
White



Regolabile
Adjustable



1083

L71 (max 81,5) x P31 x H17 cm

Tende doccia

Shower curtains - Rideaux de douche
Duschvorhänge - Cortinas de baño - Занавески для ванной

Tende doccia in TESSUTO

Fabric Shower Curtains

SIMBOLOGIA



100% poliestere impermeabilizzato - 100% waterproof polyester - 100% polyester imperméable - 100% Polyester wasserfest - 100% poliester impermeabilizado - 100% водонепроницаемый полиэстер



100% impermeabile
100% waterproof
100% imperméable
100% wasserdicht
100% impermeable
100% водонепроницаемость



Occhielli in ottone
Brass eyelets
Oeillets en laiton
Messing Ösen
Ojales de latón
Латунные проушины

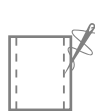

Cucita ai lati (no sfilacciamenti)
Its sides are sewed to avoid frayings
Cousue sur les côtés (sans effilochages)
An den Seiten genäht (kein Ausfransen)
Cosida en los laterales (no se deshilacha)
боковые отстрочки (во избежание разлохмачивания кромок)



GARANZIA
WARRANTY

No sostanze tossiche
No toxic substances



Lavabile in lavatrice
Machine washable

Le tende doccia Gedy in tessuto sono realizzate in Poliestere al 100% e trattate per renderle impermeabili e resistenti alle macchie. Il tessuto ed i colori utilizzati sono certificati come completamente atossici. L'orlo inferiore contiene un filo di polipropilene per mantenere la tenda in ordine e sempre tesa. La tenda è fornita completa di anelli. Ogni tenda è garantita per 3 anni.

Les rideaux de douche en tissu de Gedy sont fabriqués en 100% Polyester, ils sont traités à la résine pour les rendre imperméables et résistants aux taches. Le tissu et les couleurs utilisés sont certifiés non-toxiques. L'ourlet en bas contient un fil de polypropylène pour maintenir le rideau rangé et toujours tendu. Le rideau de douche est livré avec anneaux. Chaque rideau est garanti 3 ans.

Las cortinas de baño de tejido Gedy están hechas de 100% poliéster y están tratadas para que sean impermeables y resistentes a las manchas. El tejido y los colores utilizados están certificados como completamente no tóxicos. El borde inferior contiene un hilo de polipropileno para que la cortina esté siempre en orden y extendida. La cortina se suministra con anillas. Todas las cortinas tienen una garantía de 3 años.

Gedy fabric shower curtains are made in Polyester 100% treated with waterproof resin. The raw materials and colours are certified as completely non-toxic. Into the hem there is a polypropylene thread that keeps the curtains always tidy and tight. All curtains are supplied with rings. Each shower curtain features a 3-year warranty.

Gedy Textil-Duschvorhänge bestehen aus 100% Polyester und sind imprägniert und wasser- und schmutzabweisend. Die verwendeten Stoffe und Farben sind als vollständig ungiftig und entsprechend zertifiziert. Im unteren Saum befindet sich ein Beschwerungsband aus Polypropylen, das dafür sorgt, dass der Duschvorhang immer ordentlich bleibt und nach unten fällt. Der Duschvorhang wird komplett mit Vorhangringen geliefert. Jeder Duschvorhang verfügt über 3 Jahre Garantie.

Занавески из ткани Gedy изготовлены из 100% полиэстера с защитной обработкой для обеспечения водонепроницаемости и стойкости к образованию пятен. Используемая ткань и краски прошли сертификацию как полностью нетоксичные. Нижняя кромка с полипропиленовой нитью для поддержания натяжения. К занавеске прилагаются крючки. Каждая занавеска имеет гарантию 3 года.



Neve.

Decoro JACQUARD
With decoration JACQUARD

GEDY



cod. 1328
Bianco
White

cm. 120 x 200 **TTE 1328 1230**
cm. 180 x 200 **TTE 1328 1830**
cm. 240 x 200 **TTE 1328 2430**

Anelli inclusi
Rings included
Anneaux fournis
Ringe enthalten
Anillas incluidas
Кольца включены



Spiraglio.

Decoro trasparente in PEVA
With transparent decoration in PEVA

GEDY



cod. 1310
Bianco/Trasparente
White/Transparent

cm. 120 x 200 **TTE 1310 1230**
cm. 180 x 200 **TTE 1310 1830**
cm. 240 x 200 **TTE 1310 2430**

Anelli incorporati
Built-in rings
Anneaux intégrés
Eingebaute Ringe
Anillos incorporados
Кольца включены



ACCESSORI DOCCIA . SHOWER ACCESSORIES



Basic.

GEDY

Anelli inclusi - Rings included
Anneaux fournis - Ringe enthalten
Anillas incluidas - Кольца включены



cod. 1000
Bianco
White



cod. 1001
Azzurro
Light blue

cm. 180 x 200 **TTE 1000 1830**
cm. 180 x 200 **TTE 1001 1830**

Vaniglia.

GEDY

Anelli inclusi - Rings included
Anneaux fournis - Ringe enthalten
Anillas incluidas - Кольца включены



cod. 1003
Bianco
White

cm. 120 x 200 **TTE 1003 1230**
cm. 180 x 200 **TTE 1003 1830**
cm. 240 x 200 **TTE 1003 2430**



Araldica.

GEDY



cod. 1325
Beige

Anelli inclusi - Rings included
Anneaux fournis - Ringe enthalten
Anillas incluidas - Кольца включены



cm. 120 x 200 **TTE 1325 1230**
cm. 180 x 200 **TTE 1325 1830**
cm. 240 x 200 **TTE 1325 2430**



Caffè.

GEDY



cod. 1302
Bianco/beige/marrone
White/beige/brown

Anelli inclusi - Rings included
Anneaux fournis - Ringe enthalten
Anillas incluidas - Кольца включены



cm. 120 x 200 **TTE 1302 1230**
cm. 180 x 200 **TTE 1302 1830**
cm. 240 x 200 **TTE 1302 2430**



Cielo.

GEDY



cod. 1327
Celeste
Sky-blue

Anelli inclusi - Rings included
Anneaux fournis - Ringe enthalten
Anillas incluidas - Кольца включены



Desiderio.

GEDY



cod. 1355
Bianco/nero
White/black

Anelli inclusi - Rings included
Anneaux fournis - Ringe enthalten
Anillas incluidas - Кольца включены



cm. 120 x 200 **TTE 1327 1230**
cm. 180 x 200 **TTE 1327 1830**
cm. 240 x 200 **TTE 1327 2430**

cm. 120 x 200 **TTE 1355 1230**
cm. 180 x 200 **TTE 1355 1830**
cm. 240 x 200 **TTE 1355 2430**



Elegance.

GEDY



cod. 1316
Bianco/grigio/nero
White/grey/black

Anelli inclusi - Rings included
Anneaux fournis - Ringe enthalten
Anillas incluidas - Кольца включены



cm. 120 x 200 **TTE 1316 1230**
cm. 180 x 200 **TTE 1316 1830**
cm. 240 x 200 **TTE 1316 2430**



Eucalipto.

GEDY



cod. 1304
Verde
Green

Anelli inclusi - Rings included
Anneaux fournis - Ringe enthalten
Anillas incluidas - Кольца включены



cm. 120 x 200 **TTE 1304 1230**
cm. 180 x 200 **TTE 1304 1830**
cm. 240 x 200 **TTE 1304 2430**



Flora.

GEDY

Anelli inclusi - Rings included
Anneaux fournis - Ringe enthalten
Anillas incluidas - Кольца включены



cod. 1320
Rosa/giallo
Pink/yellow

cm. 120 x 200 **TTE 1320 1230**
cm. 180 x 200 **TTE 1320 1830**
cm. 240 x 200 **TTE 1320 2430**



Frammenti.

GEDY

Anelli inclusi - Rings included
Anneaux fournis - Ringe enthalten
Anillas incluidas - Кольца включены



cod. 1315
Blu
Blue

cm. 120 x 200 **TTE 1315 1230**
cm. 180 x 200 **TTE 1315 1830**
cm. 240 x 200 **TTE 1315 2430**



Frenesia.

GEDY



cod. 1303
Rosa/giallo/turchese
Pink/yellow/turquoise

cm. 120 x 200 **TTE 1303 1230**
cm. 180 x 200 **TTE 1303 1830**
cm. 240 x 200 **TTE 1303 2430**

Anelli inclusi - Rings included
Anneaux fournis - Ringe enthalten
Anillas incluidas - Кольца включены



Frizz.

GEDY



cod. 1313
Blu
Blue

cm. 120 x 200 **TTE 1313 1230**
cm. 180 x 200 **TTE 1313 1830**
cm. 240 x 200 **TTE 1313 2430**

Anelli inclusi - Rings included
Anneaux fournis - Ringe enthalten
Anillas incluidas - Кольца включены



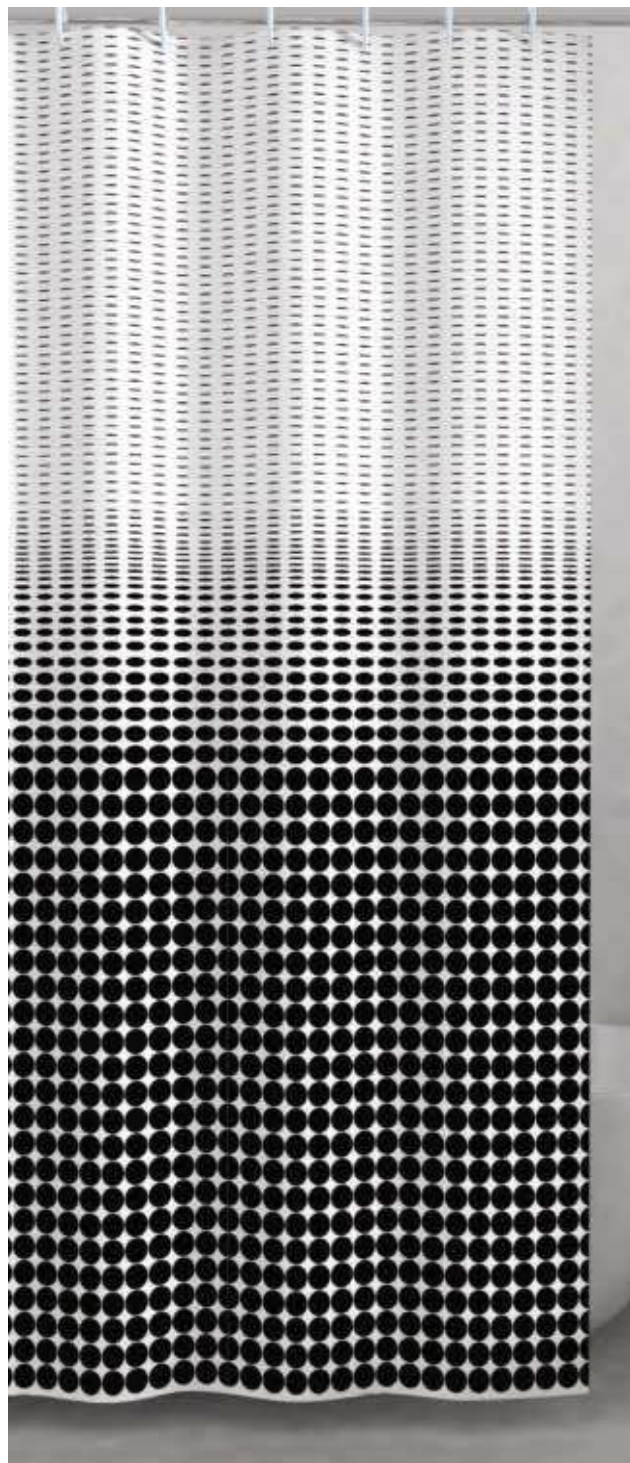

Gomitolo.

Anelli inclusi - Rings included
 Anneaux fournis - Ringe enthalten
 Anillas incluidas - Кольца включены



GEDY



cod. 1326
 Verde/marrone
 Green/brown

cm. 120 x 200 **TTE 1326 1230**
 cm. 180 x 200 **TTE 1326 1830**
 cm. 240 x 200 **TTE 1326 2430**

Ipnosi.

Anelli inclusi - Rings included
 Anneaux fournis - Ringe enthalten
 Anillas incluidas - Кольца включены



GEDY



cod. 1314
 Bianco/nero
 White/black

cm. 120 x 200 **TTE 1314 1230**
 cm. 180 x 200 **TTE 1314 1830**
 cm. 240 x 200 **TTE 1314 2430**



Jeans.

GEDY

Anelli inclusi - Rings included
Anneaux fournis - Ringe enthalten
Anillas incluidas - Кольца включены



cod. 1307
Multicolore
Multicolor

cm. 120 x 200 **TTE 1307 1230**
cm. 180 x 200 **TTE 1307 1830**
cm. 240 x 200 **TTE 1307 2430**



Lady Mary.

GEDY

Anelli inclusi - Rings included
Anneaux fournis - Ringe enthalten
Anillas incluidas - Кольца включены



cod. 1305
Grigio/Rosa
Grey/Pink

cm. 120 x 200 **TTE 1305 1230**
cm. 180 x 200 **TTE 1305 1830**
cm. 240 x 200 **TTE 1305 2430**

ACCESSORI DOCCIA . SHOWER ACCESSORIES



Living.

GEDY



cod. 1323
Beige/bianco/nero
Beige/white/black

cm. 120 x 200 **TTE 1323 1230**
cm. 180 x 200 **TTE 1323 1830**
cm. 240 x 200 **TTE 1323 2430**



Oltremare.

GEDY



cod. 1306
Beige/azzurro
Beige/light blue

cm. 120 x 200 **TTE 1306 1230**
cm. 180 x 200 **TTE 1306 1830**
cm. 240 x 200 **TTE 1306 2430**

Anelli inclusi - Rings included
Anneaux fournis - Ringe enthalten
Anillas incluidas - Кольца включены



Anelli inclusi - Rings included
Anneaux fournis - Ringe enthalten
Anillas incluidas - Кольца включены





Orizzonti.

GEDY



cod. 1301
Celeste
Sky-blue

Anelli inclusi - Rings included
Anneaux fournis - Ringe enthalten
Anillas incluidas - Кольца включены



Parallele.

GEDY



cod. 1321
Grigio
Grey

Anelli inclusi - Rings included
Anneaux fournis - Ringe enthalten
Anillas incluidas - Кольца включены



cm. 120 x 200 **TTE 1301 1230**
cm. 180 x 200 **TTE 1301 1830**
cm. 240 x 200 **TTE 1301 2430**

cm. 120 x 200 **TTE 1321 1230**
cm. 180 x 200 **TTE 1321 1830**
cm. 240 x 200 **TTE 1321 2430**



Parfume.

GEDY



cod. 1322
Bianco/nero
White/black

Anelli inclusi - Rings included
Anneaux fournis - Ringe enthalten
Anillas incluidas - Кольца включены



cm. 120 x 200 **TTE 1322 1230**
cm. 180 x 200 **TTE 1322 1830**
cm. 240 x 200 **TTE 1322 2430**



Piper.

GEDY



cod. 1318
Beige/nero
Beige/black

Anelli inclusi - Rings included
Anneaux fournis - Ringe enthalten
Anillas incluidas - Кольца включены



cm. 120 x 200 **TTE 1318 1230**
cm. 180 x 200 **TTE 1318 1830**
cm. 240 x 200 **TTE 1318 2430**



Ricordi.

GEDY



cod. 1324
Celeste/turchese/nero
Sky-blue/turquoise/black

Anelli inclusi - Rings included
Anneaux fournis - Ringe enthalten
Anillas incluidas - Кольца включены



cm. 120 x 200 **TTE 1324 1230**
cm. 180 x 200 **TTE 1324 1830**
cm. 240 x 200 **TTE 1324 2430**



Riva.

GEDY



cod. 1309
Blu
Blue

Anelli inclusi - Rings included
Anneaux fournis - Ringe enthalten
Anillas incluidas - Кольца включены



cm. 120 x 200 **TTE 1309 1230**
cm. 180 x 200 **TTE 1309 1830**
cm. 240 x 200 **TTE 1309 2430**

ACCESSORI DOCCIA . SHOWER ACCESSORIES



Spiaggia.

GEDY



cod. 1317
Beige/marrone
Beige/brown

cm. 120 x 200 **TTE 1317 1230**
cm. 180 x 200 **TTE 1317 1830**
cm. 240 x 200 **TTE 1317 2430**



Stancil.

GEDY



cod. 1319
Grigio
Grey

cm. 120 x 200 **TTE 1319 1230**
cm. 180 x 200 **TTE 1319 1830**
cm. 240 x 200 **TTE 1319 2430**

Anelli inclusi - Rings included
Anneaux fournis - Ringe enthalten
Anillas incluidas - Кольца включены



Anelli inclusi - Rings included
Anneaux fournis - Ringe enthalten
Anillas incluidas - Кольца включены





Tecno.

GEDY

Anelli inclusi - Rings included
Anneaux fournis - Ringe enthalten
Anillas incluidas - Кольца включены



cod. 1308
Grigio
Grey

cm. 120 x 200 **TTE 1308 1230**
cm. 180 x 200 **TTE 1308 1830**
cm. 240 x 200 **TTE 1308 2430**

Tratto.

GEDY

Anelli inclusi - Rings included
Anneaux fournis - Ringe enthalten
Anillas incluidas - Кольца включены



cod. 1312
Celeste/turchese
Sky-blue/turquoise

cm. 120 x 200 **TTE 1312 1230**
cm. 180 x 200 **TTE 1312 1830**
cm. 240 x 200 **TTE 1312 2430**

ACCESSORI DOCCIA . SHOWER ACCESSORIES



Vivaio.

GEDY

Anelli inclusi - Rings included
Anneaux fournis - Ringe enthalten
Anillas incluidas - Кольца включены



cod. 1311
Verde
Green

cm. 120 x 200 **TTE 1311 1230**
cm. 180 x 200 **TTE 1311 1830**
cm. 240 x 200 **TTE 1311 2430**

Tende doccia in PEVA

PEVA Shower Curtains

SIMBOLOGIA



GARANZIA
WARRANTY



No sostanze tossiche
No toxic substances



Riducibile
Reducible

Il PEVA è un materiale ecologico riciclabile senza dispersione di sostanze tossiche nell'ambiente. Completamente inodore - Spessore consistente per evitare che la tenda aderisca al corpo durante la doccia. La tenda è fornita completa di anelli.

Le PEVA est un matériau écologique recyclable sans dispersion de substances toxiques dans l'environnement - complètement inodore - grande épaisseur pour éviter que le rideau n'adhère au corps pendant la douche. Le rideau de douche est livré avec anneaux.

El PEVA es un material ecológico reciclable sin dispersión de sustancias tóxicas en el medio ambiente - completamente inodoro - de gran grosor para evitar que la cortina se adhiera al cuerpo durante la ducha. La cortina se suministra con anillas.

PEVA is an eco-friendly material that can be recycled without leaking toxic substances into the environment - completely odour free - and featuring adequate thickness to prevent the curtain from sticking to the body when showering. All curtains are supplied with rings.

PEVA ist ein ökologisches Material, das sich recyceln lässt, ohne dass giftige Stoffe in die Umwelt gelangen - völlig geruchlos - dickes Material, um zu verhindern, dass der Vorhang beim Duschen am Körper haften bleibt. Der Duschvorhang wird mit Vorhangringen geliefert.

PEVA - это экологичный рециклируемый материал, не выделяющий вредных веществ в окружающую среду - абсолютно лишен запаха - повышенная плотность во избежание прилипания шторы к телу во время принятия душа. К занавеске прилагаются крючки.

ACCESSORI DOCCIA . SHOWER ACCESSORIES



Ice.

Decoro 3D
With decoration 3D

GEDY



cod. 1357
Bianco
White

cm. 180 x 200 **TVI 1357 1830**

Anelli inclusi
Rings included
Anneaux fournis
Ringe enthalten
Anillas incluidas
Кольца включены



Square.

Decoro 3D
With decoration 3D

GEDY



cod. 1358
Bianco
White



cod. 1359
Azzurro
Light blue

cm. 180 x 200 **TVI 1358 1830**
cm. 180 x 200 **TVI 1359 1830**

Anelli inclusi
Rings included
Anneaux fournis
Ringe enthalten
Anillas incluidas
Кольца включены





Vetro.

Decoro 3D
With decoration 3D

GEDY



cod. 1356
Bianco
White

cm. 180 x 200 **TVI 1356 1830**

Anelli inclusi
Rings included
Anneaux fournis
Ringe enthalten
Anillas incluidas
Кольца включены



Basic.

GEDY



cod. 1000
Bianco
White



cod. 1001
Azzurro
Light blue

cm. 180 x 200 **TVI 1000 1830**
cm. 180 x 200 **TVI 1001 1830**

Anelli inclusi
Rings included
Anneaux fournis
Ringe enthalten
Anillas incluidas
Кольца включены





Zucchero.

Anelli inclusi - Rings included
 Anneaux fournis - Ringe enthalten
 Anillas incluidas - Кольца включены



GEDY



cod. 1002
 Bianco
 White

cm. 120 x 200 **TVI 1002 1230**
 cm. 180 x 200 **TVI 1002 1830**
 cm. 240 x 200 **TVI 1002 2430**

Biglie.

Anelli inclusi - Rings included
 Anneaux fournis - Ringe enthalten
 Anillas incluidas - Кольца включены



GEDY



cod. 1341
 Verde/blu
 Green/blue

cm. 120 x 200 **TVI 1341 1230**
 cm. 180 x 200 **TVI 1341 1830**
 cm. 240 x 200 **TVI 1341 2430**



Ciotoli.

GEDY

Anelli inclusi - Rings included
Anneaux fournis - Ringe enthalten
Anillas incluidas - Кольца включены



cod. 1344
Azzurro
Light blue

cm. 120 x 200 **TVI 1344 1230**
cm. 180 x 200 **TVI 1344 1830**
cm. 240 x 200 **TVI 1344 2430**



Circles.

GEDY

Anelli inclusi - Rings included
Anneaux fournis - Ringe enthalten
Anillas incluidas - Кольца включены



cod. 1351
Grigio/acquamarina
Grey/aquamarine

cm. 120 x 200 **TVI 1351 1230**
cm. 180 x 200 **TVI 1351 1830**
cm. 240 x 200 **TVI 1351 2430**



Domino.

Anelli inclusi - Rings included
Anneaux fournis - Ringe enthalten
Anillas incluidas - Кольца включены



GEDY



cod. 1329
Grigio
Grey

cm. 120 x 200 **TVI 1329 1230**
cm. 180 x 200 **TVI 1329 1830**
cm. 240 x 200 **TVI 1329 2430**



Foliage.

Anelli inclusi - Rings included
Anneaux fournis - Ringe enthalten
Anillas incluidas - Кольца включены



GEDY



cod. 1353
Grigio
Grey

cm. 120 x 200 **TVI 1353 1230**
cm. 180 x 200 **TVI 1353 1830**
cm. 240 x 200 **TVI 1353 2430**



Frame.

GEDY

Anelli inclusi - Rings included
Anneaux fournis - Ringe enthalten
Anillas incluidas - Кольца включены



cod. 1349
Azzurro/grigio
Light blue/grey

cm. 120 x 200 **TVI 1349 1230**
cm. 180 x 200 **TVI 1349 1830**
cm. 240 x 200 **TVI 1349 2430**



Frammenti.

GEDY

Anelli inclusi - Rings included
Anneaux fournis - Ringe enthalten
Anillas incluidas - Кольца включены



cod. 1315
Azzurro
Light blue

cm. 120 x 200 **TVI 1315 1230**
cm. 180 x 200 **TVI 1315 1830**
cm. 240 x 200 **TVI 1315 2430**

ACCESSORI DOCCIA . SHOWER ACCESSORIES



Incanto.

GEDY

Anelli inclusi - Rings included
Anneaux fournis - Ringe enthalten
Anillas incluidas - Кольца включены



Jump.

GEDY

Anelli inclusi - Rings included
Anneaux fournis - Ringe enthalten
Anillas incluidas - Кольца включены



cod. 1352
Grigio
Grey



cod. 1331
Azzurro
Light blue

cm. 120 x 200 **TVI 1352 1230**
cm. 180 x 200 **TVI 1352 1830**
cm. 240 x 200 **TVI 1352 2430**

cm. 120 x 200 **TVI 1331 1230**
cm. 180 x 200 **TVI 1331 1830**
cm. 240 x 200 **TVI 1331 2430**



Jungle.

GEDY

Anelli inclusi - Rings included
Anneaux fournis - Ringe enthalten
Anillas incluidas - Кольца включены



cod. 1342
Bianco
White

cm. 120 x 200 **TVI 1342 1230**
cm. 180 x 200 **TVI 1342 1830**
cm. 240 x 200 **TVI 1342 2430**



Lens.

GEDY

Anelli inclusi - Rings included
Anneaux fournis - Ringe enthalten
Anillas incluidas - Кольца включены



cod. 1346
Bianco
White

cm. 120 x 200 **TVI 1346 1230**
cm. 180 x 200 **TVI 1346 1830**
cm. 240 x 200 **TVI 1346 2430**

ACCESSORI DOCCIA . SHOWER ACCESSORIES



Liane.

GEDY



cod. 1343
Multicolore
Multicolor

Anelli inclusi - Rings included
Anneaux fournis - Ringe enthalten
Anillas incluidas - Кольца включены



cm. 120 x 200 **TVI 1343 1230**
cm. 180 x 200 **TVI 1343 1830**
cm. 240 x 200 **TVI 1343 2430**



Nidi.

GEDY



cod. 1333
Grigio
Grey

Anelli inclusi - Rings included
Anneaux fournis - Ringe enthalten
Anillas incluidas - Кольца включены



cm. 120 x 200 **TVI 1333 1230**
cm. 180 x 200 **TVI 1333 1830**
cm. 240 x 200 **TVI 1333 2430**

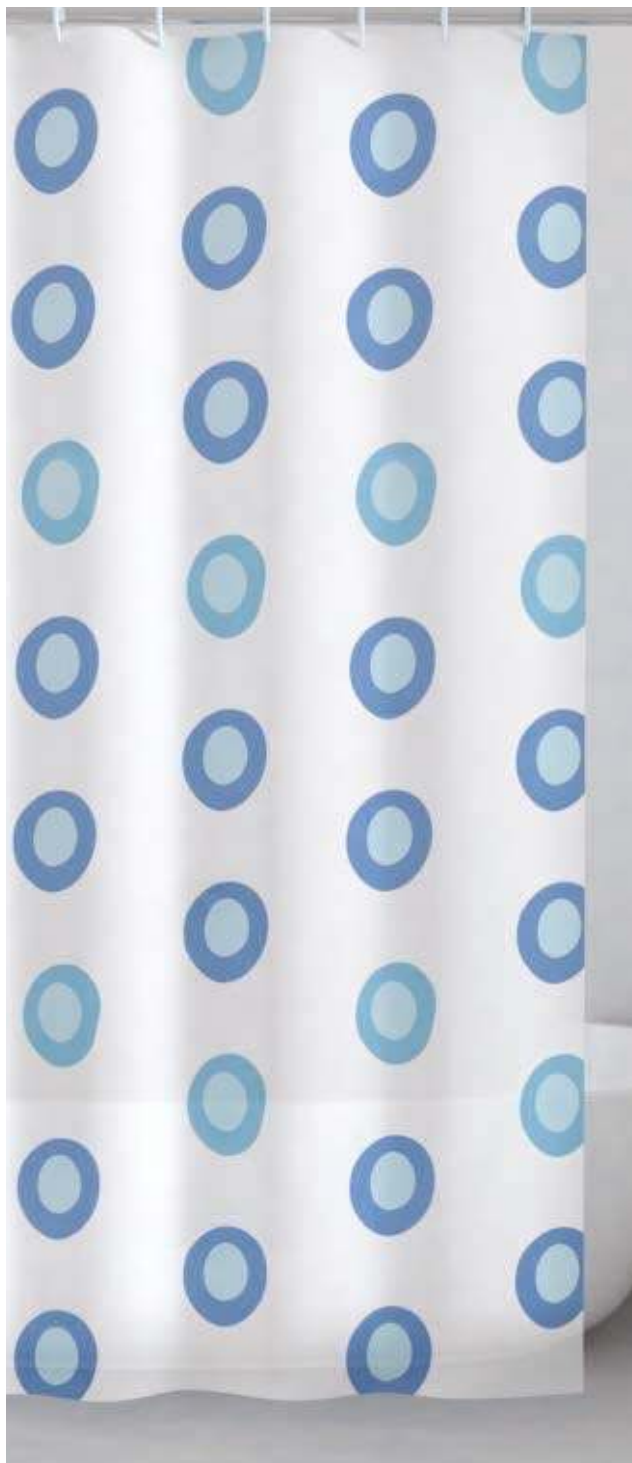

Oblò.

GEDY



cod. 1348
Azzurro
Light blue

Anelli inclusi - Rings included
Anneaux fournis - Ringe enthalten
Anillas incluidas - Кольца включены



Orbita.

GEDY



cod. 1340
Azzurro
Light blue

Anelli inclusi - Rings included
Anneaux fournis - Ringe enthalten
Anillas incluidas - Кольца включены



cm. 120 x 200 **TVI 1348 1230**
cm. 180 x 200 **TVI 1348 1830**
cm. 240 x 200 **TVI 1348 2430**

cm. 120 x 200 **TVI 1340 1230**
cm. 180 x 200 **TVI 1340 1830**
cm. 240 x 200 **TVI 1340 2430**



Paradise.

Anelli inclusi - Rings included
 Anneaux fournis - Ringe enthalten
 Anillas incluidas - Кольца включены



GEDY



cod. 1347
 Multicolore
 Multicolor

cm. 120 x 200 **TVI 1347 1230**
 cm. 180 x 200 **TVI 1347 1830**
 cm. 240 x 200 **TVI 1347 2430**

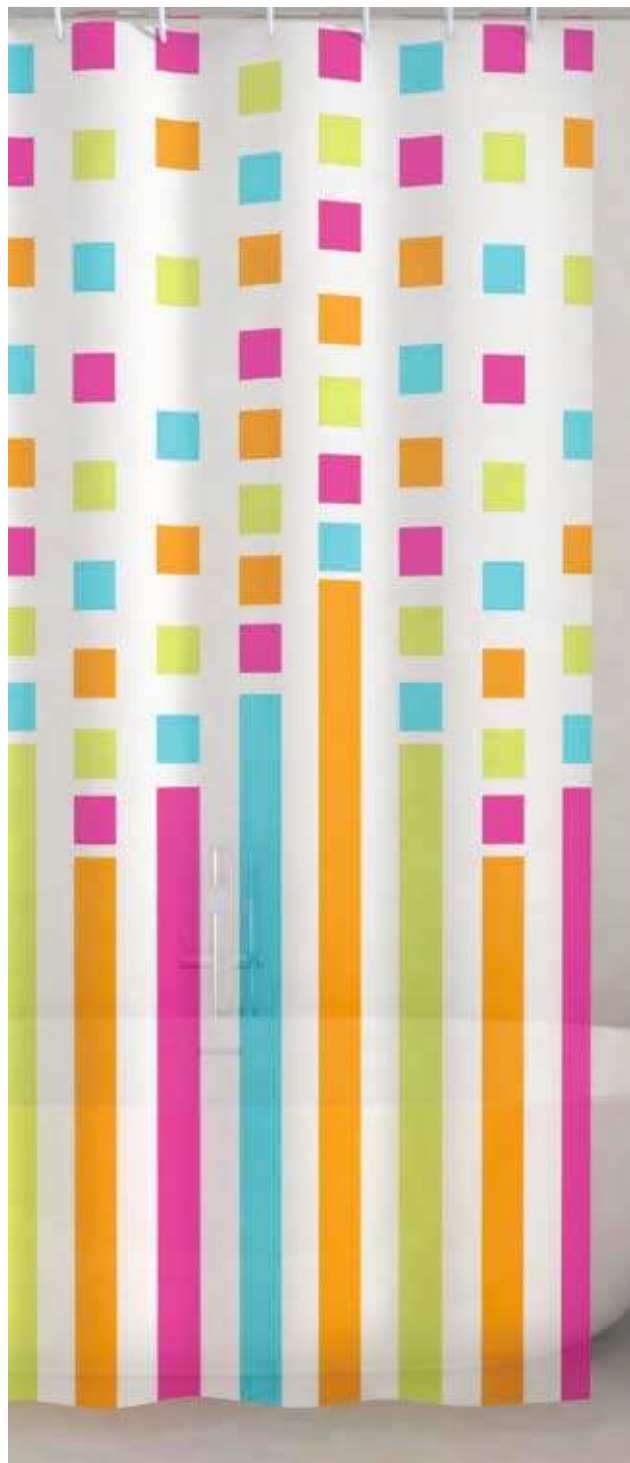

Party.

Anelli inclusi - Rings included
 Anneaux fournis - Ringe enthalten
 Anillas incluidas - Кольца включены



GEDY



cod. 1330
 Multicolore
 Multicolor

cm. 120 x 200 **TVI 1330 1230**
 cm. 180 x 200 **TVI 1330 1830**
 cm. 240 x 200 **TVI 1330 2430**

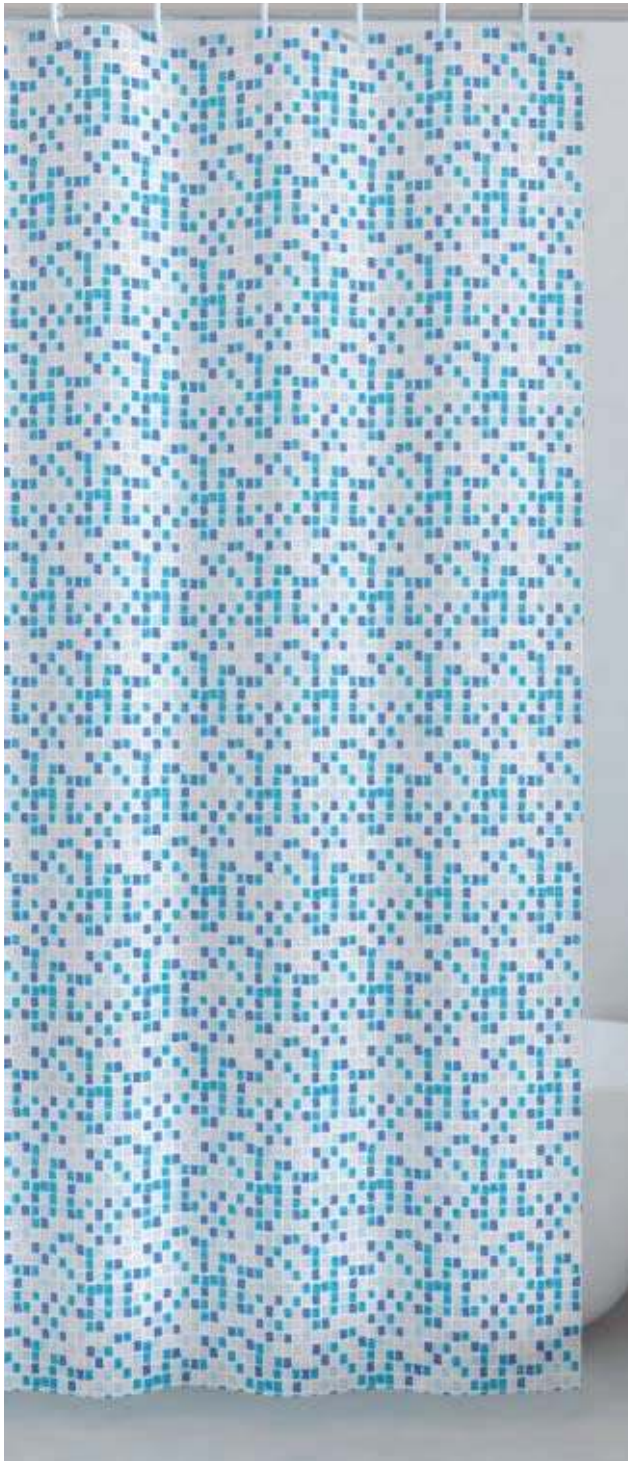

Pool.

GEDY

Anelli inclusi - Rings included
Anneaux fournis - Ringe enthalten
Anillas incluidas - Кольца включены



cod. 1332
Azzurro
Light blue

cm. 120 x 200 **TVI 1332 1230**
cm. 180 x 200 **TVI 1332 1830**
cm. 240 x 200 **TVI 1332 2430**



Pot Pourri.

GEDY

Anelli inclusi - Rings included
Anneaux fournis - Ringe enthalten
Anillas incluidas - Кольца включены



cod. 1336
Lilla/rosa
Lilla/pink

cm. 120 x 200 **TVI 1336 1230**
cm. 180 x 200 **TVI 1336 1830**
cm. 240 x 200 **TVI 1336 2430**

ACCESSORI DOCCIA . SHOWER ACCESSORIES



Prisma.

Anelli inclusi - Rings included
Anneaux fournis - Ringe enthalten
Anillas incluidas - Кольца включены



GEDY



cod. 1350
Bianco
White

cm. 120 x 200 **TVI 1350 1230**
cm. 180 x 200 **TVI 1350 1830**
cm. 240 x 200 **TVI 1350 2430**

Rugiada.

Anelli inclusi - Rings included
Anneaux fournis - Ringe enthalten
Anillas incluidas - Кольца включены



GEDY



cod. 1338
Azzurro
Light blue

cm. 120 x 200 **TVI 1338 1230**
cm. 180 x 200 **TVI 1338 1830**
cm. 240 x 200 **TVI 1338 2430**



Schema.

GEDY

Anelli inclusi - Rings included
Anneaux fournis - Ringe enthalten
Anillas incluidas - Кольца включены



cod. 1345
Celeste/turquoise
Light blue/turquoise

cm. 120 x 200 **TVI 1345 1230**
cm. 180 x 200 **TVI 1345 1830**
cm. 240 x 200 **TVI 1345 2430**



Strüdel.

GEDY

Anelli inclusi - Rings included
Anneaux fournis - Ringe enthalten
Anillas incluidas - Кольца включены



cod. 1339
Bianco
White

cm. 120 x 200 **TVI 1339 1230**
cm. 180 x 200 **TVI 1339 1830**
cm. 240 x 200 **TVI 1339 2430**



Tablet.

GEDY



cod. 1334
Azzurro
Light blue

cm. 120 x 200 **TVI 1334 1230**
cm. 180 x 200 **TVI 1334 1830**
cm. 240 x 200 **TVI 1334 2430**

Anelli inclusi - Rings included
Anneaux fournis - Ringe enthalten
Anillas incluidas - Кольца включены



Tic-Toc.

GEDY



cod. 1354
Bianco
White

cm. 120 x 200 **TVI 1354 1230**
cm. 180 x 200 **TVI 1354 1830**
cm. 240 x 200 **TVI 1354 2430**

Anelli inclusi - Rings included
Anneaux fournis - Ringe enthalten
Anillas incluidas - Кольца включены





Tracce.

GEDY

Anelli inclusi - Rings included
Anneaux fournis - Ringe enthalten
Anillas incluidas - Кольца включены



cod. 1337
Azzurro
Light blue

cm. 120 x 200 **TVI 1337 1230**
cm. 180 x 200 **TVI 1337 1830**
cm. 240 x 200 **TVI 1337 2430**



Tropical.

GEDY

Anelli inclusi - Rings included
Anneaux fournis - Ringe enthalten
Anillas incluidas - Кольца включены



cod. 1335
Azzurro/giallo
Light blue/yellow

cm. 120 x 200 **TVI 1335 1230**
cm. 180 x 200 **TVI 1335 1830**
cm. 240 x 200 **TVI 1335 2430**

Tende doccia IGNIFUGA in poliester e

Fire-proof polyester shower curtain
Rideau de douche en polyester ignifuge
Duschvorhang aus feuerhemmendem Polyester
Cortina de ducha de poliéster ignífuga
Занавеска для душа из огнестойкого полиэстера

IGNIFUGA - CLASSE 1

Il tessuto ideale per alberghi e comunità.
The ideal fabric for hotels and communities.
Le tissu idéal pour hôtels et communautés.
Der ideale Stoff für Hotel und Gemeinschaften.
El material ideal para hoteles y comunidades.
Идеальная ткань для гостиниц и общественных зданий.



Tinta unita.

GEDY



cod. 6129
Bianco
White

Anelli inclusi - Rings included
Anneaux fournis - Ringe enthalten
Anillas incluidas - Кольца включены



100% MADE
in Italy



cm. 120 x 200 **TVI 6129 6712**
cm. 180 x 200 **TVI 6129 6718**
cm. 240 x 200 **TVI 6129 6724**

Pieghehella 180°

PIEGHELLA 180° SENZA TENDA
PIEGHELLA 180° WITHOUT SHOWER CURTAIN
PIEGHELLA 180° SANS RIDEAU
PIEGHELLA 180° OHNE VORHANG
PIEGHELLA 180° SIN CORTINA
PIEGHELLA 180° БЕЗ ЗАНАВЕСКИ

Reggitenda pieghevole adatto per vasche da bagno e docce. Montaggio semplicissimo con quattro viti e tasselli a muro. Supporto e fissaggio invisibile con bracci d'acciaio.

Fold-away shower rail and curtain. Screws and wall plugs includes. Invisible fixing system with steel arms.

Cabine de douche pliable pour baignoires et douches. Montage très simple avec quatre vis. Support et fixation invisible avec bras en acier.

Duschschirm ausklappbar für Wannen und Duschen aller Größen. Montage einfachst mit beigefügten Schrauben und Dübeln.

Varillaje para bañeras y duchas. Montaje muy fácil con 4 tornillos y tacos.

Раздвижной карниз для ванн и душевых. Максимально простой монтаж посредством четырех винтов и стеновых дюбелей. Опора и невидимый крепеж со стальными кронштейнами.



TPIE 1801310.

GEDY

Pieghehella 8 braccia
con apertura max 180°

Acciaio inox e resine termoplastiche

Stainless steel and thermoplastic resins
Acier inoxydable et thermoplastique
Edelstahl und Kunststoff
Acero inox y resinas termoplásticas
Нержавеющей стали и термопластичных смол



x2

apertura 90°



apertura 180°

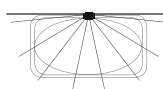

Anelli per tende doccia

Rings for shower curtains - Anneaux pour rideaux de douche
Vorhangringe - Anillas para cortinas de ducha
Кольца для занавески



TANE100.

GEDY

Resine termoplastiche

Thermoplastic resins
Résine thermoplastique
Kunststoff
Resinas termoplásticas
Термопластичные смолы

12 pz/pcs

L4,1 x P0,6 x H6 cm



00
Trasparente
Transparent

02
Bianco
White

Supporto a soffitto per telai reggitenda altezza regolabile

Ceiling support for shower rails-height adjustable
Support fixation plafond pour barre de douche (hauteur réglable)
Deckenhalterung für Duschstangen (höhenverstellbar)
Soporte de techo para barras de ducha (altura regulable)
Потолочная опора для штанг для занавесок (регулируемая высота)



13
Cromato
Chromed

TCAV600.

GEDY

Acciaio e ottone

Steel and brass
Acier et laiton
Stahl und Messing
Acero y latón
Стали и латуни

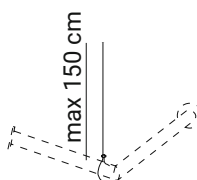

Asta doccia estensibile

Extensible shower rail - Barre de douche extensible
Teleskopduschstange - Barra extensible para cortinas
Раздвижная штанга для душа

TEST700.

Alluminio con laccatura epossidica e resine termoplastiche

Epoxy lacquered aluminium and thermoplastic resins
Aluminium laquage époxi et thermoplastique
Aluminium mit Epoxid-Beschichtung und Kunststoff
Aluminio pintado epoxi y resinas termoplásticas
Алюминий с эпоксидным покрытием и термопластичные смолы



02
Bianco
White



Alluminio anodizzato e resine termoplastiche

Anodized aluminum and thermoplastic resins
Aluminium anodisé et thermoplastique
Eloxiertes Aluminium und Kunststoff
Aluminio anodizado y resinas termoplásticas
анодированный алюминий и термопластичные смолы



13
Alluminio anodizzato
Anodized aluminum

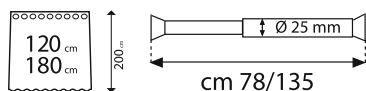

TEST701.

Alluminio con laccatura epossidica e resine termoplastiche

Epoxy lacquered aluminium and thermoplastic resins
Aluminium laquage époxi et thermoplastique
Aluminium mit Epoxid-Beschichtung und Kunststoff
Aluminio pintado epoxi y resinas termoplásticas
Алюминий с эпоксидным покрытием и термопластичные смолы



02
Bianco
White



Alluminio anodizzato e resine termoplastiche

Anodized aluminum and thermoplastic resins
Aluminium anodisé et thermoplastique
Eloxiertes Aluminium und Kunststoff
Aluminio anodizado y resinas termoplásticas
анодированный алюминий и термопластичные смолы



13
Alluminio anodizzato
Anodized aluminum

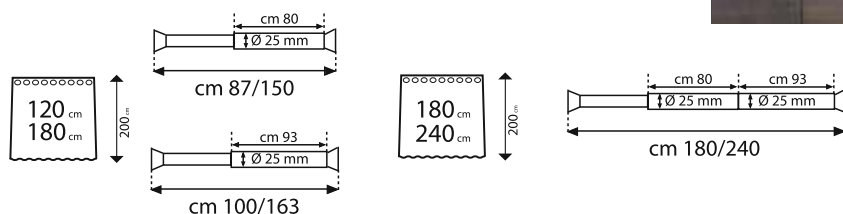

Asta doccia angolare

Corner shower rail - Barre angulaire de douche
Eckduschstange - Barra angular para cortinas
Угловые карнизы для душевой занавески

TANG800.

Alluminio con laccatura epossidica e resine termoplastiche

Epoxy lacquered aluminium and thermoplastic resins
Aluminium laquage époxi et thermoplastique
Aluminium mit Epoxid-Beschichtung und Kunststoff
Aluminio pintado epoxi y resinas termoplásticas
Алюминий с эпоксидным покрытием и термопластичные смолы

Alluminio anodizzato e resine termoplastiche

Anodized aluminum and thermoplastic resins
Aluminium anodisé et thermoplastique
Eloxiertes Aluminium und Kunststoff
Aluminio anodizado y resinas termoplásticas
анодированный алюминий и термопластичные смолы



02
Bianco
White



13
Alluminio
anodizzato
Anodized
aluminum

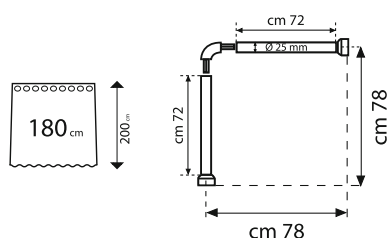

TANG801.

Alluminio con laccatura epossidica e resine termoplastiche

Epoxy lacquered aluminium and thermoplastic resins
Aluminium laquage époxi et thermoplastique
Aluminium mit Epoxid-Beschichtung und Kunststoff
Aluminio pintado epoxi y resinas termoplásticas
Алюминий с эпоксидным покрытием и термопластичные смолы

Alluminio anodizzato e resine termoplastiche

Anodized aluminum and thermoplastic resins
Aluminium anodisé et thermoplastique
Eloxiertes Aluminium und Kunststoff
Aluminio anodizado y resinas termoplásticas
анодированный алюминий и термопластичные смолы



02
Bianco
White



13
Alluminio
anodizzato
Anodized
aluminum

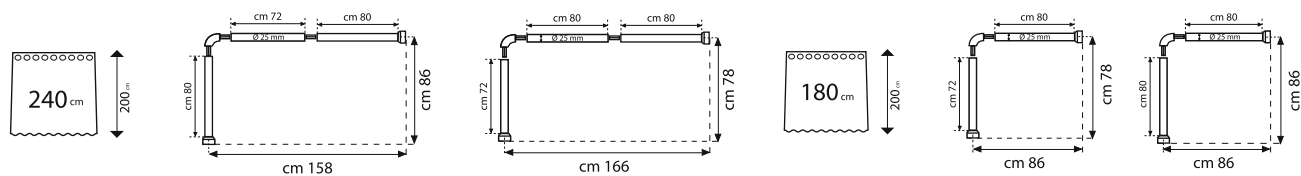

TANG802.

Alluminio con laccatura epossidica e resine termoplastiche

Epoxy lacquered aluminium and thermoplastic resins
 Aluminium laquage époxi et thermoplastique
 Aluminium mit Epoxid-Beschichtung und Kunststoff
 Aluminio pintado epoxi y resinas termoplásticas
 Алюминий с эпоксидным покрытием и термопластичные смолы



02
Bianco
 White

Alluminio anodizzato e resine termoplastiche

Anodized aluminum and thermoplastic resins
 Aluminium anodisé et thermoplastique
 Eloxiertes Aluminium und Kunststoff
 Aluminio anodizado y resinas termoplásticas
 анодированный алюминий
 и термопластичные смолы



13
Alluminio anodizzato
 Anodized aluminum

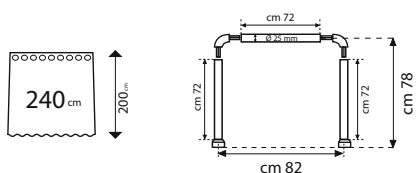

TANG803.

Alluminio con laccatura epossidica e resine termoplastiche

Epoxy lacquered aluminium and thermoplastic resins
 Aluminium laquage époxi et thermoplastique
 Aluminium mit Epoxid-Beschichtung und Kunststoff
 Aluminio pintado epoxi y resinas termoplásticas
 Алюминий с эпоксидным покрытием и термопластичные смолы



02
Bianco
 White

Alluminio anodizzato e resine termoplastiche

Anodized aluminum and thermoplastic resins
 Aluminium anodisé et thermoplastique
 Eloxiertes Aluminium und Kunststoff
 Aluminio anodizado y resinas termoplásticas
 анодированный алюминий
 и термопластичные смолы



13
Alluminio anodizzato
 Anodized aluminum

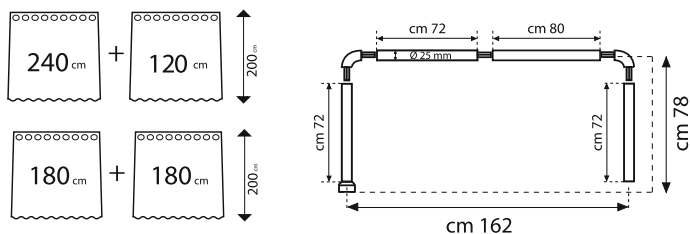

TUNI900.

Alluminio con laccatura epossidica e resine termoplastiche

Epoxy lacquered aluminium and thermoplastic resins
 Aluminium laquage époxi et thermoplastique
 Aluminium mit Epoxid-Beschichtung und Kunststoff
 Aluminio pintado epoxi y resinas termoplásticas
 Алюминий с эпоксидным покрытием и термопластичные смолы



02
Bianco
 White

Alluminio anodizzato e resine termoplastiche

Anodized aluminum and thermoplastic resins
 Aluminium anodisé et thermoplastique
 Eloxierter Aluminium und Kunststoff
 Aluminio anodizado y resinas termoplásticas
 анодированный алюминий и термопластичные смолы



13
Alluminio anodizzato
 Anodized aluminum

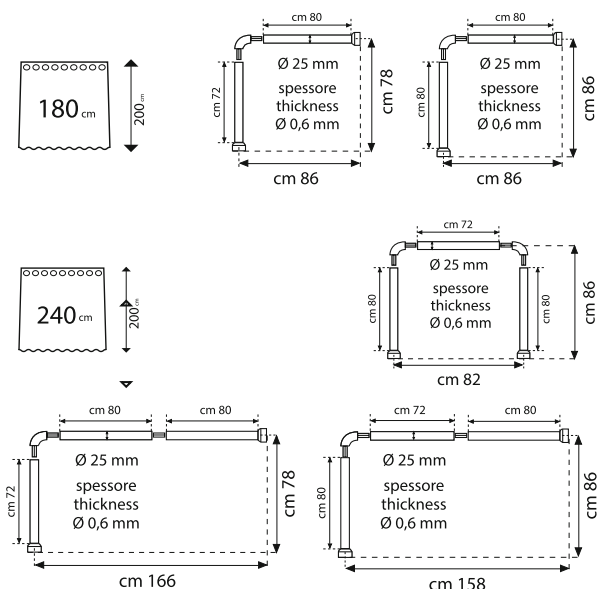

TSEM800.

Alluminio con laccatura epossidica e resine termoplastiche

Epoxy lacquered aluminium and thermoplastic resins
 Aluminium laquage époxi et thermoplastique
 Aluminium mit Epoxid-Beschichtung und Kunststoff
 Aluminio pintado epoxi y resinas termoplásticas
 Алюминий с эпоксидным покрытием и термопластичные смолы



02
Bianco
 White

Alluminio anodizzato e resine termoplastiche

Anodized aluminum and thermoplastic resins
 Aluminium anodisé et thermoplastique
 Eloxierter Aluminium und Kunststoff
 Aluminio anodizado y resinas termoplásticas
 анодированный алюминий и термопластичные смолы



13
Alluminio anodizzato
 Anodized aluminum

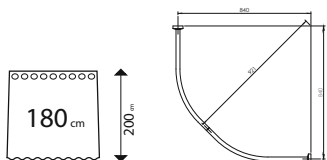



TAPPETI DA BAGNO

Bath rugs



TAPPETI DA BAGNO - BATH RUGS



Tile.

100% cotone

cotton-coton - Baumwolle
algodón Хлопок

GEDY



Antiscivolo
Antislip



02
Bianco
White



03
Beige



08
Grigio
Grey



96TI5050

L50 x P50 cm



96TI6090

L90 x P60 cm



96TI6512

L120 x P65 cm



Land.

100% cotone

cotton-coton - Baumwolle
algodón Хлопок

GEDY



Antiscivolo
Antislip



03
Beige



07
Verde
Green



11
Azzurro
Light blue



96LA5050

L50 x P50 cm



96LA6090

L90 x P60 cm



96LA6512

L120 x P66 cm



Miss.

100% cotone

cotton-coton - Baumwolle
algodón Хлопок

GEDY



Antiscivolo
Antislip



07
Verde
Green



08
Grigio
Grey



10
Rosa
Pink



96MI5080

L80 x P50 cm



Bubble.

45% cotone

cotton-coton-Baumwolle-algodón- хлопка

55% poliestere

polyester-polyester-polyester

poliéster-Полиэстер

GEDY



05
Blu
Blue



08
Grigio
Grey



66
Tortora chiaro
Light turtledove
grey



Antiscivolo
Antislip



96BU5050

L50 x P50 cm



96BU5080

L80 x P50 cm



Knot.

45% cotone

cotton-coton-Baumwolle-algodón- хлопка

55% poliestere

polyester-polyester-polyester

poliéster-Полиэстер

GEDY



05
Blu
Blue



07
Verde
Green



08
Grigio
Grey



Antiscivolo
Antislip



96KN5050

L50 x P50 cm



96KN5080

L80 x P50 cm



TAPPETI DA BAGNO - BATH RUGS

Fuzzy.

NEW

GEDY

100% poliestere

polyester-polyester-polyester

poliéster-Полиэстер



Antiscivolo
Antislip



02
Bianco
White



07
Verde
Green



08
Grigio
Grey



10
Rosa
Pink



96FY4060
L60 x P40 cm



96FY5080
L80 x P50 cm

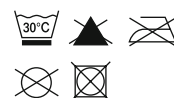



08
Grigio
Grey



85
Antracite
Anthracite



Memory
Foam



Antiscivolo
Antislip



Mousse.



100% poliestere
polyester-polyester-polyester
poliéster-Полиэстер



96MS4060
L60 x P40 cm



96MS5080
L80 x P50 cm

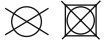



IDROTERAPIA

Hydrotherapy





GARANZIA
WARRANTY

Doccette Hand showers

Le doccette GEDY sono presentate in una gamma ampia per design, numero di funzioni e prezzo. Sono tutte dotate di filtro antisabbia, tettarelle che permettono una facile rimozione del calcare accumulatosi e di un filtro che permette la riduzione fino al 50% del consumo di acqua. Tutti gli attacchi sono nella misura universale standard 1/2".

GEDY shower heads are available in a wide range of designs, function and prices. All have sand filter, nipples for easy scale removal, and a filter to cut water consumption by up to 50%. All attachments are in the universal standard size of 1/2".

Les douchettes GEDY sont présentées dans une vaste gamme subdivisée suivant le design, le nombre de fonctions et le prix. Elles sont toutes munies d'un filtre anti-sable, de pièces qui facilitent l'élimination du calcaire et d'un filtre qui permet de réduire jusqu'à 50% la consommation d'eau. Tous les raccords sont fournis dans la dimension universelle standard de 1/2 pouces.

Die Handduschen GEDY werden hinsichtlich Design, Anzahl der Funktionen und Preis in einer großen Palette präsentiert. Alle ausgestattet mit Sandfilter, Einsatz für eine einfache Entfernung von Kalkablagerungen sowie Filter für die Verringerung des Wasserverbrauch um bis zu 50 %. Alle Anschlüsse mit den Standard-Universalmaßen 1/2".

Los mangos de ducha GEDY están disponibles en una amplia gama de modelos distintos por diseño, número de funciones y precio. Todos están dotados de filtro anti-arena, eyectores que permiten una fácil remoción de la cal acumulada y de un filtro que permite reducir hasta el 50% el consumo de agua. Todas las conexiones son de tipo universal estándar de 1/2".

Ручные души GEDY представлены в широком ассортименте по дизайну, количеству функций и стоимости. Все они оснащены фильтром для задержки песка, легко чистящимися от скопившейся накипи соплами и регулятором расхода, позволяющим сэкономить до 50% воды. Все соединения универсальные, отвечающие стандарту 1/2".



Risparmio idrico
Water saving



Universale
Standard



Filtro Antisabbia
Sand filter



Pulizia facile
Easy clean



Anticalcare
Anti-limestone

Realizzate in ABS

Made of ABS

Réalisés en ABS

Hergestellt aus ABS

Realizados en ABS

Изготовлено из АБС пластик

Top.

GEDY

I microfori garantiscono un risparmio dell'acqua e una maggior pressione del getto.

Micro holes guarantee water saving and increased jet pressure. - Embout à picots pour économiser l'eau et augmenter la pression du jet. - Mikrolöcher die Wasser sparen und den Strahl Druck erhöhen. Micro orificios que garantizan el ahorro de agua y una mayor presión del chorro. - микроотверстия, которые обеспечивают экономию воды и усиливают напор струи.



Maggiore pressione del getto
Stronger jet spray

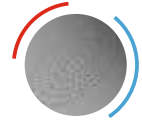

Microfori
Microholes



1 Jet



Tonic



Azione purificante dell'acqua

Water purifying action



Acciaio inox AISI 304 e resine termoplastiche

Stainless steel AISI 304 and thermoplastic resins
Acier inoxydable AISI 304 et résine thermoplastique
Edelstahl AISI 304 und Kunststo
Acero inox AISI 304 y resinas termoplásticas
Нержавеющей стали AISI 304 и термопластиченых смол



Cromato
Chromed



TOP 04 PURE - GYHS10404

ø 8 x 7,5 x 23,5 cm



1 Jet



Tonic



Cromato
Chromed



3 Jets



Rain



Tonic



Rain+Tonic



Cromato
Chromed



TOP 02 TONIC - GYHS10402

ø 11 x 3 x 24,5 cm

TOP 03 TONIC - GYHS10403

ø 10 x 5,2 x 23,5 cm

Acciaio inox AISI 304 e ABS

Stainless steel AISI 304 and ABS - Acier inoxydable AISI 304 et ABS
Edelstahl AISI 304 und ABS - Acero inox AISI 304 y ABS
Нержавеющей стали AISI 304 и АБС

IDROTERAPIA . HYDROTHERAPY .



TOP 00 - GYHS10400
ø 12 x 6 x 26 cm



TOP 01 - GYHS10401
ø 15 x 10 x 28 cm

5 Jets



Rain



Tonic



Massage



Rain+Tonic



Rain+Massage



Cromato
Chromed



4 Jets



Rain



Tonic



Soft



Cascade



Acqua stop



Tech.

GEDY



TECH 13 - GYHS10313
ø12 x 7,8 x 24,5 cm



TECH 12 - GYHS10312
ø 12 x 5,2 x 24,6 cm

3 Jets



Rain



Tonic



Rain+Tonic



Nero matt
Matt black



3 Jets



Rain



Tonic



Rain+Tonic



Cambio getti a pulsante
Push system jets change



Doccette - Hand showers .



3 Jets

Rain

Massage

Rain+Massage

Cromato Chromed



Cambio getti a pulsante
Push system jets change

TECH 10 - GYHS10310

ø 8 x 5,2 x 26 cm



3 Jets

Rain

Cascade

Rain+Cascade

Cromato Chromed



TECH 08 - GYHS10308

ø 11 x 7,5 x 24,1 cm



3 Jets

Rain

Tonic

Rain+Tonic

Cromato Chromed



TECH 02 - GYHS10302

ø 12,2 x 8 x 24,6 cm



3 Jets

Rain

Tonic

Rain+Tonic

Cromato/Bianco Chromed/White



TECH 01 - GYHS10301

ø 12,2 x 8 x 24,6 cm



1 Jet

Rain

Cromato Chromed



TECH 00 - GYHS10300

ø 12,2 x 8,5 x 24,6 cm

Star.

GEDY



1 J e t



R a i n



Cromato
Chromed



STAR 00 - GYHS10200

ø 8 x 5 x 22 cm



STAR 04 - GYHS10204

ø 10,1 x 6 x 24,6 cm



2 J e t s



R a i n



T o n i c



Cromato
Chromed



STAR 01 - GYHS10201

ø 8 x 8,8 x 21 cm



STAR 05 - GYHS10205

ø 10,2 x 6,3 x 24,8 cm

Trendy.

GEDY



1 Jet



Rain



Cromato
Chromed



TRENDY 00 - GYHS10100

ø 3,2 x 20,8 cm



TRENDY 01 - GYHS10101

ø 7 x 6,6 x 20,9 cm



TRENDY 02 - GYHS10102

L 4,3 x 3,9 x 22,8 cm



TRENDY 03 - GYHS10103

ø 6,8 x 10,8 x 23 cm



TRENDY 05 - GYHS10105

L3 x 3 x 20,8 cm



3 Jets



Rain



Tonic



Rain+Tonic

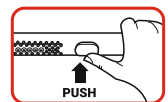

Cambio getti
a pulsante
Push system
jets change



TRENDY 04 - GYHS10104

ø 3 x 3,1 x 22,1 cm

Easy.

GEDY



1 Jet



Rain



Cromato
Chromed

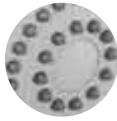

EASY 00 - GYHS10000

ø 6,2 x 5,3 x 17,9 cm



Cromato
Chromed



EASY 02 - GYHS10002

ø 6,9 x 12,8 x 17,4 cm



Bianco
White

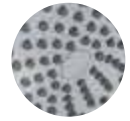

EASY 03 - GYHS10003

ø 8 x 7,3 x 19,2 cm



Nero matt
Matt black

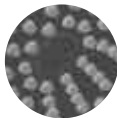

EASY 04 - GYHS10004

ø 8 x 7,3 x 19,2 cm



Cromato
Chromed



EASY 05 - GYHS10005

ø 8,5 x 8,5 x 19,5 cm



4 Jets



Rain



Massage



Soft



Tonic



Cromato
Chromed

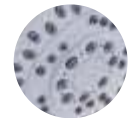

EASY 06 - GYHS10006

ø 8,4 x 6,5 x 19,5 cm

Basic.

GEDY



1 Jet



Rain



Bianco
White



BASIC 00 - GYHS09000

ø 6,5 x 10,3 x H17,7 cm

Music.

GEDY



Cromato/Bianco
Chromed/White



1 Jet



Rain



Bluetooth



MUSIC 00 - GYHS11100
ø 12,5 x 6,2 x 25,4 cm

Thermo.

GEDY



3 Jets



Rain



Tonic



Rain + Tonic



Cromato
Chromed

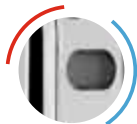

Temperature
check point



THERMO 00 - GYHS10900
ø 11,9 x 6 x 26,1 cm



Bianco
White

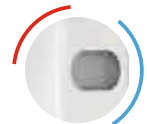

Temperature
check point



THERMO 01 - GYHS10901
ø 11,9 x 6 x 26,1 cm



Thermo Light.

GEDY



1 Jet



Rain



Color
change

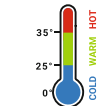

Temperature
control



Cromato
Chromed



Temperature
check point



THERMO LIGHT 00 - GYHS10800

ø 12,1 x 4,4 x 24 cm



Bianco
White



Temperature
check point



THERMO LIGHT 01 - GYHS10801

ø 12,1 x 4,4 x 24 cm



Nero
Black



Temperature
check point



THERMO LIGHT 02 - GYHS10802

ø 12,1 x 4,4 x 24 cm

Light.

GEDY



3 Jets



Rain



Tonic



Rain + Tonic



Cromato
Chromed



Color
change



LIGHT 00 - GYHS10700

ø 10 x 6,8 x 24,9 cm



Bianco
White



Color
change



LIGHT 01 - GYHS10701

ø 10 x 6,8 x 24,9 cm



Cromato
Chromed



Color
change



LIGHT 06 - GYHS10706

ø 11,3 x 10,8 x 24,9 cm



Cromato
Chromed



Color
change

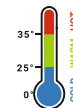

Temperature
control

LIGHT 09 - GYHS10709

ø 11,3 x 10,8 x 24,9 cm

Liberty.

GEDY



1 Jet



Rain



Cromato
Chromed

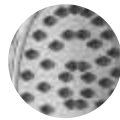

LIBERTY 00 - GYHS10600

ø 9 x 9,6 x 22,7 cm



Bronzo
Bronze



LIBERTY 01 - GYHS10601

ø 9 x 9,6 x 22,7 cm



Rame
Copper



LIBERTY 02 - GYHS10602

ø 9 x 9,6 x 22,7 cm



Tendence.

GEDY



1 Jet



Rain



Cromato/Bianco
Chromed/White

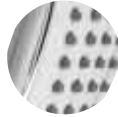

TENDENCE 02 - GYHS10502

6,3 x 7,5 x 24,5 cm



Cromato/Bianco
Chromed/White



TENDENCE 03 - GYHS10503

ø 6,3 x 7,5 x 24,5 cm



Cromato/Bianco
Chromed/White



TENDENCE 06 - GYHS10506

ø 10,4 x 4 x 25,3 cm



Cromato/Nero
Chromed/Black

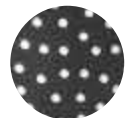

TENDENCE 07 - GYHS10507

ø 10,4 x 4 x 25,3 cm



Cromato/Bianco
Chromed/White

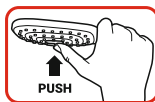

Pulizia calcare a pulsante

Anti-limestone push system

TENDENCE 08 - GYHS10508

10,1 x 7,2 x 25,8 cm



3 Jets



Rain



Massage



Rain+Massage



Cromato/Bianco
Chromed/White

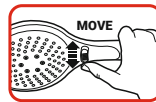

Cambio getti a leva

Lever jets change

TENDENCE 00 - GYHS10500

ø 13,9 x 5,8 x 26,3 cm

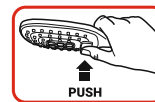

Cambio getti a pulsante

Push system jets change

TENDENCE 10 - GYHS10510

10,1 x 7,2 x 25,8 cm



GARANZIA
WARRANTY

Duplex Shower kits

Alcune doccette della nostra gamma vengono presentate in una pratica confezione per il consumatore che include un flessibile in acciaio inox da cm.150 e un supporto a parete.

Some shower heads in our range are sold in a practical package for the customer, which includes a 150 cm stainless steel hose plus a wall bracket.

Certaines douchettes de notre gamme sont présentées dans un emballage pratique pour le consommateur, avec un tuyau flexible en acier inox de 150 cm et un support mural.

Einige Handduschen unserer Produktpalette werden in einer praktischen Konfektion für den Verbraucher präsentiert, die einen Schlauch aus Edelstahl zu 150 cm sowie eine Wandhalterung umfasst.

Igunos mangos de ducha de nuestra gama están contenidos dentro de una caja muy práctica para el consumidor que incluye un flexo de acero inoxidable de 150 cm y un soporte de pared.

Некоторые ручные души нашей коллекции представлены в виде практично упакованных комплектов, включающих шланг из нержавеющей стали на 150 см. и настенное крепление.



Risparmio idrico
Water saving



Universale
Standard



Filtro Antisabbia
Sand filter



Pulizia facile
Easy clean



Anticalcare
Anti-limestone



Universale
Standard



Doppia aggraffatura
Double Lock



Antitorsione
Anti-Twist



Resistente alle piegature
Anti-Fold



Resistente
Resistente

Realizzati in ABS, acciaio inox e ottone

Made of ABS, stainless steel and brass
Réalisés en ABS, acier inoxydable and laiton
Hergestellt aus ABS, Edelstahl und Messing
Realizados en ABS, acero inox y latón
Изготовлено из АБС,
нержавеющей стали и латуни

High Pro.

GEDY



Cromato
Chromed



HIGH PRO 08 - GYCSHP08



HIGH PRO 09 - GYCSHP09



1 Jet

ABS

TRENDY 00 - GYHS10100

ø 3,2 x 20,8 cm



1 Jet

ABS

TRENDY 05 - GYHS10105

3 x 3 x 20,8 cm



Ottone
Brass

OXY CLIP EASY 00 - GYAC11300

5,5 x 8 x 5,8 cm



Ottone
Brass

OXY CLIP PLUS 00 - GYAC11400

5 x 8,5 x 5,5 cm



PVC

SILVER 00 - GYFX10700

150 cm



PVC

SILVER 00 - GYFX10700

150 cm

Top.

GEDY

Cromato
Chromed



TOP 00 - GYSK10400
ø 12 x 12,1 x 28,7 cm

5 Jets

- Rain
- Tonic
- Massage
- Rain+Tonic
- Rain+Massage



TOP 01 - GYHS10401
ø 13,5 x 15,9 x 30,5 cm

4 Jets

- Rain
- Tonic
- Soft
- Cascade

Acqua stop

Tech.

GEDY

Cromato
Chromed



TECH 06 - GYSK10306
ø 11,8 x 14,5 x 27 cm

5 Jets

- Rain
- Tonic
- Massage
- Rain+Tonic
- Rain+Massage

Cromato
Chromed



TECH 05 - GYSK10305
ø 11,8 x 14,5 x 27 cm

3 Jets

- Rain
- Tonic
- Rain+Tonic

Nichel spazzolato
Brushed nickel



TECH 03 - GYSK10303
ø 12,1 x 14,2 x 27 cm



Cromato
Chromed



1 Jet



Rain

TECH 00 - GYSK10300

ø 12,1 x 14,7 x 27 cm



Cromato
Chromed



3 Jets



Rain



Tonic



Rain+Tonic

TECH 02 - GYSK10302

ø 12,1 x 14,2 x 27 cm

Star.

GEDY



Cromato
Chromed



2 Jets



Rain



Tonic

STAR 01 - GYSK10201

ø 8 x 12,1 x 25,8 cm



1 Jet



Rain

STAR 00 - GYSK10200

ø 8 x 12,1 x 25,8 cm



IDROTERAPIA . HYDROTHERAPY .



3 Jets



Rain



Tonic



Rain+Tonic

STAR 05 - GYSK10205

ø 10,1 x 8,8 x 29,5 cm



1 Jet



Rain

STAR 04 - GYSK10204

ø 10,1 x 8,8 x 29,5 cm

Trendy.

GEDY



1 Jet



Rain



Cromato
Chromed



TRENDY 03 - GYSK10103

L8,9 x 16,4 x 25,2 cm



TRENDY 01 - GYSK10101

ø 9,6 x 14 x 24,3 cm



TRENDY 02 - GYSK10102

L7,7 x 8,9 x 25,9 cm

Easy.

GEDY

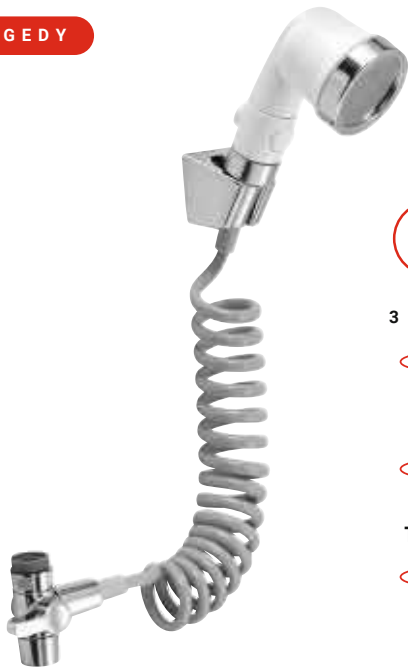

Bianco
White



3 Jets



Rain



Tonic



Soft

EASY 07 - GYSK10007

6,5 x 7,5 x 16 cm

NEW



Cromato
Chromed



4 Jets



Rain



Massage



Soft



Tonic

EASY 06 - GYSK10006

ø 8,4 x 10,8 x 23 cm



1 Jet



Rain



Cromato
Chromed



EASY 05 - GYSK10005

ø 8,5 x 9,5 x 22,4 cm



EASY 02 - GYSK10002

ø 6,9 x 14,4 x 20 cm



EASY 00 - GYSK10000

ø 6,2 x 8,5 x 21 cm

Speedy.

GEDY



Cromato
Chromed



SPEEDY 00- GYSK99000

ø 8,5 x 6,5 x 23 cm

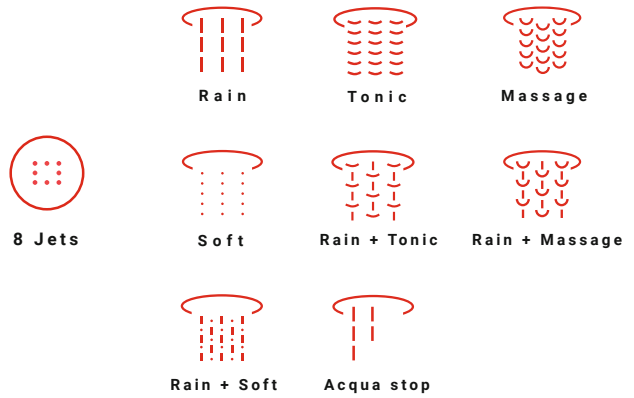

Music.

GEDY



1 Jet



Rain



Cromato/Bianco
Chromed/White



Bluetooth

MUSIC 00 - GYSK11100

ø 12,3 x 12,3 x 27,9 cm

Liberty.

GEDY



1 Jet



Rain



Cromato
Chromed



Bronzo
Bronze



Rame
Copper

LIBERTY 00 - GYSK10600

ø 9 x 25 x 24,4 cm

LIBERTY 01 - GYSK10601

ø 9 x 25 x 24,4 cm

LIBERTY 02 - GYSK10602

ø 9 x 25 x 24,4 cm

Tendence.

GEDY



1 Jet



Rain



Bianco
White



Nero
Black



Cromato/Bianco
Chromed/White



Cromato/Nero
Chromed/Black



TENDENCE 06 - GYSK10506

ø 10,4 x 7,2 x 30 cm

TENDENCE 07 - GYSK10507

ø 10,4 x 7,2 x 30 cm

TENDENCE 02 - GYSK10502

6,3 x 11,5 x 29,3 cm

TENDENCE 03 - GYSK10503

6,3 x 11,5 x 29,3 cm



GARANZIA
WARRANTY

Set doccia Shower sets

Alcuni soffioni della nostra gamma vengono presentati in una pratica confezione per il consumatore che include un flessibile da cm.150, una doccetta e un supporto a parete.

Some head showers in our range are sold in a practical package for the customer, which includes a 150 cm hose, a hand shower and a wall bracket.

Certaines pommeaux de douche de notre gamme sont présentées dans un emballage pratique pour le consommateur, avec un tuyau flexible de 150 cm, une douchette et un support mural.

Einige Duschköpfe unserer Produktpalette werden in einer praktischen Konfektion für den Verbraucher präsentiert, die einen Schlauch zu 150 cm, Handbrause sowie eine Wandhalterung umfasst.

Igunos rociadores de ducha de nuestra gama están contenidos dentro de una caja muy práctica para el consumidor que incluye un flexo de 150 cm, un mango de ducha y un soporte de pared.

Некоторые душ глава нашей коллекции представлены в виде практично упакованных комплектов, включающих шланг на 150 см., ручные души и настенное крепление.



Risparmio idrico
Water saving



Universale
Standard



Filtro Antisabbia
Sand filter



Pulizia facile
Easy clean



Anticalcare
Anti-limestone



Universale
Standard



Doppia aggraffatura
Double Lock



Antitorsione
Anti-Twist



Resistente
alle piegature
Anti-Fold



Resistent
Resistente

Doccette realizzate in ABS, supporti muro realizzati in ottone, soffioni realizzati acciaio inox AISI 304 e flessibili realizzati in PVC
 Heands shower made of ABS, shower brackets made of brass, head showers made of stainless steel AISI 304 and hoses made of PVC
 Douchettes réalisés en ABS, supports douchette réalisés en laiton, pommeaux réalisés en acier inoxydable AISI 304 and flexibles de douche en PVC
 Handbrausen hergestellt aus ABS, Wandhalterung hergestellt aus Messing,
 Duschköpfe hergestellt aus Edelstahl AISI 304 und Schlauch hergestellt aus PVC
 Mangos de ducha en ABS, soporte mangos de ducha en latón, rociadores de ducha en acero inox AISI 304 y flexo en PVC
 Ручные души из АБС, муро-поддержки из латуни, соффиони из нержавеющей стали AISI 304 и гибкие из ПВХ.

High Pro.

GEDY



1 Jet



Rain



Cromato
Chromed



HIGH PRO 05 - GYCSHP05



TRENDY 05 - GYHS10105

3 x 3 x 20,8 cm



OXY CLIP PLUS 00 - GYAC11400

5 x 8,5 x 5,5 cm



SILVER 00 - GYFX10700

150 cm



Ottone
Brass

TUBE TECH 35 00 - GYAC13200

6 x 37,5 x 9 cm



TECH 01 - GYSH10301

30 x 30 x 5,7 cm

IDROTERAPIA . HYDROTHERAPY .

High Pro.

GEDY



1 Jet



Rain



Cromato
Chromed



HIGH PRO 04 - GYCSHP04



TRENDY 00 - GYHS10100

Ø 3,2 x 20,8 cm



OXY CLIP EASY 00 - GYAC11300

5,5 x 8 x 5,8 cm



SILVER 00 - GYFX10700

150 cm



Acciaio inox
Stainless steel

TUBE STAR 35 00 - GYAC12800

Ø 5,5 x 37 x 11,5 cm

AISI
304



TECH 00 - GYSH10300

Ø 30 x 5,2 cm

High Pro.

GEDY



1 Jet



Rain



Cromato
Chromed

HIGH PRO 03 - GYCSHP03



TRENDY 05 - GYHS10105

3 x 3 x 20,8 cm



OXY CLIP PLUS 00 - GYAC11400

5 x 8,5 x 5,5 cm



SILVER 00 - GYFX10700

150 cm



TUBE TECH 35 00 - GYAC13200

6 x 37,5 x 9 cm

AISI
304



TECH 05 - GYSH10305

25 x 25 x 5 cm

HIGH PRO 02 - GYCSHP02



TRENDY 00 - GYHS10100

Ø 3,2 x 20,8 cm



OXY CLIP EASY 00 - GYAC11300

5,5 x 8 x 5,8 cm



SILVER 00 - GYFX10700

150 cm

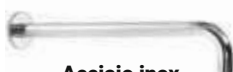

TUBE STAR 35 00 - GYAC12800

Ø 5,5 x 37 x 11,5 cm

AISI
304



TECH 04 - GYSH10304

Ø 25 x 5 cm



High Pro.

GEDY



1 Jet



Rain



Cromato
Chromed

HIGH PRO 07 - GYCSHP07



TRENDY 05 - GYHS10105

3 x 3 x 20,8 cm

HIGH PRO 06 - GYCSHP06



TRENDY 00 - GYHS10100

Ø 3,2 x 20,8 cm



OXY CLIP PLUS 00 - GYAC11400

5 x 8,5 x 5,5 cm



OXY CLIP EASY 00 - GYAC11300

5,5 x 8 x 5,8 cm



SILVER 00 - GYFX10700

150 cm



SILVER 00 - GYFX10700

150 cm



Ottone
Brass

TUBE TECH 30 00 - GYAC13100

6 x 32,5 x 9 cm



Acciaio inox
Stainless steel

TUBE STAR 30 00 - GYAC12700

Ø 5,5 x 30 x 11,3 cm

AISI
304



TECH 03 - GYSH10303

20 x 20 x 5 cm

AISI
304



TECH 02 - GYSH10302

Ø 20 x 5 cm





GARANZIA
WARRANTY

Saliscendi Shower slider rails

A completamento della gamma doccette, GEDY propone anche la versione saliscendi, anche con interasse variabile del supporto a muro in modo da coprire fori a parete preesistenti, completa di flessibile in acciaio inox da cm.150 e di un porta sapone/porta oggetti. Disponibili anche una versione senza portasapone e la sola barra con saliscendi di ricambio.

To complete the range of shower heads, GEDY also offers the sliding bar version, with a variable fastening distance so as to cover existing holes in the wall and complete with 150 cm flexible hose and a soap/object dish. Also available without soap dish and with spare sliding bar.

Pour compléter la gamme des douchettes, GEDY propose également la version avec une barre de douche, munie d'un entraxe variable du support mural de manière à couvrir les trous préexistants dans le mur, et un tuyau flexible en acier inox de 150 cm et un porte-savon/porte-objets. On propose également une version sans porte-savon, comprenant uniquement la barre avec un dispositif de coulissement de rechange.

Zur Vervollständigung der Handduschenpalette bietet GEDY auch die Version mit Wandschiene an, auch mit variablem Abstand der Wandhalterung zur Abdeckung der in der Wand vorhandenen Bohrungen, vollständig mit Schlauch aus Edelstahl zu 150 cm und Seifenhalter/Ablage. Auch verfügbar in einer Version ohne Seifenhalter und nur Ersatz-Wandschiene.

Para completar la gama de mangos de ducha, GEDY propone también la versión con soporte deslizante, también con distancia entre ejes variable del soporte de pared para tapar los agujeros ya existentes en la pared, completa de flexo de acero inoxidable de 150 cm y de una jabonera/porta-objetos. Disponible también una versión sin jabonera y solo la barra con soporte deslizante de repuesto.

Для дополнения коллекции душей компания GEDY предлагает также исполнение со штангой, в том числе с подвижным настенным креплением, позволяющим скрыть существующие на стене отверстия, в комплекте со шлангом из нержавеющей стали на 150 см. и мыльницей/полочкой. Возможен вариант штанги со сменными держателями без мыльницы.



Risparmio idrico
Water saving



Universale
Standard



Filtro Antisabbia
Sand filter



Pulizia facile
Easy clean



Anticalcare
Anti-limestone



Interasse
variabile
Adjustable
distance



Universale
Standard



Doppia aggraffatura
Double Lock



Antitorsione
Anti-Twist



Resistente
alle piegature
Anti-Fold



Resistent
Resistente



Top.

GEDY



Cromato
Chromed



5 Jets



Rain



Tonic



Soft



Cascade



Cascade + Tonic

TOP 01 - GYSS10401
17,5 x 13,4 x 75-87,5 cm

Tech.

GEDY



Nero matt
Matt black



3 Jets



Rain



Tonic



Rain+Tonic

TECH 13 - GYSS10313
16 x 10 x 63 cm



Cromato
Chromed



3 Jets



Rain



Massage



Rain+Massage



TECH 11 - GYSS10311
17,2 x 9,2 x 75 cm



TECH 10 - GYSS10310
15,2 x 8,7 x 75 cm

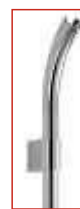

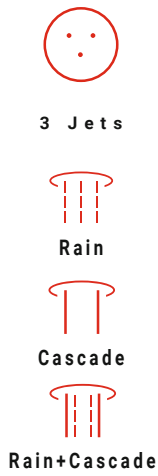

TECH 08 - GYSS10308
21 x 10 x 92 cm



TECH 06 - GYSS10306
17,2 x 11,7 x 75 cm



TECH 05 - GYSS10305
17,2 x 12,2 x 75 cm

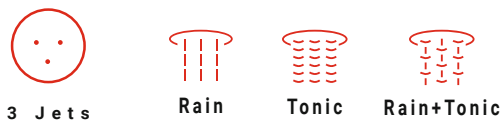

TECH 03 - GYSS10303
17,3 x 11,7 x 75 cm

Nichel spazzolato
Brushed nickel



TECH 02 - GYSS10302
17,3 x 11,7 x 75 cm

Cromato
Chromed



TECH 01 - GYSS10301
17,3 x 11,7 x 75 cm

Cromato/Bianco
Chromed/White



TECH 00 - GYSS10300
17,3 x 11,7 x 75 cm

Cromato
Chromed

Star.

GEDY



Cromato
Chromed



3 Jets



Rain



Tonic



Rain+Tonic

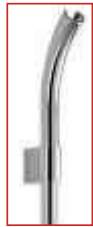

STAR 05 - GYSS10205

16,3 x 9,9 x 75 cm



1 Jet



Rain



STAR 04 - GYSS10204

16,2 x 9,5 x 75 cm



2 Jets



Rain



Tonic



STAR 01 - GYSS10201

15,2 x 12,5 x 75 cm

Trendy.

GEDY



Cromato
Chromed



1 Jet



Rain



Cromato
Chromed



Lucido
Polished



TRENDY 03 - GYSS10103

13,4 x 13,8 x 65,8

TRENDY 02 - GYSS10102

12,3 x 7,8 x 65,5

TRENDY 01 - GYSS10101

13,7 x 11,3 x 60,5

Easy.

GEDY



Lucido
Polished



EASY 06 - GYSS10006

24,5 x 11,8 x 60,5



4 Jets



Rain



Massage



Soft



Tonic



Lucido
Polished



EASY 05 - GYSS10005

14,5 x 13,8 x 60,5



1 Jet



Rain



EASY 02 - GYSS10002

13,7 x 18,1 x 60,5

Liberty.

GEDY



1 Jet



Rain



Cromato
Chromed



LIBERTY 00 - GYSS10600

9,5 x 30,5 x 74,5 cm



Bronzo
Bronze



LIBERTY 01 - GYSS10601

9,5 x 30,5 x 74,5 cm



Rame
Copper



LIBERTY 02 - GYSS10602

9,5 x 30,5 x 74,5 cm

Tendence.

GEDY



Cromato/Bianco
Chromed/White



1 Jet



Rain



Cromato/Nero matt
Chromed/Matt black



TENDENCE 06 - GYSS10506

17,6 x 19 x 81 cm



TENDENCE 07 - GYSS10507

17,6 x 19 x 81 cm



GARANZIA
WARRANTY

Colonne doccia Shower columns

Una gamma compatta che va incontro a tutti i gusti e alle funzioni richieste nella doccia, racchiuse in un solo articolo compatto e dalle giuste proporzioni.

Tutte le colonne sono regolabili in altezza per il massimo confort nella doccia per tutti i membri della famiglia.

A compact range to satisfy all tastes and all of the functions required of a shower, in a single, compact and perfectly sized item. All columns are height adjustable for maximum shower comfort for all members of the family.

Une gamme compacte qui satisfait tous les goûts et les fonctions d'une douche, réunies en un seul article compact et bien proportionné. Toutes les colonnes sont réglables en hauteur assurant le plus grand confort à l'intérieur de la douche à tous les membres de la famille.

Eine kompakte, trendige Produktpalette, die alle Funktionen einer Dusche erfüllt, und dies in einem einzigen kompakten Artikel mit den richtigen Proportionen. Alle Duschsäulen sind höhenverstellbar, um allen Mitgliedern der Familie in der Dusche den optimalen Komfort zu bieten.

Una gama compacta que satisface todos los gustos y las funciones requeridas para la ducha, unidas en un sólo artículo compacto y de proporciones adecuadas. Todas las barras para la ducha son regulables en altura para el máximo confort en la ducha de todos los miembros de la familia.

Эта компактная линейка душей отвечает всем требованиям и вкусам, объединенными в одном предмете оптимальных размеров. Все души-колонны регулируются по высоте, что обеспечивает максимальный комфорт в душе для всех членов семьи.



Risparmio idrico
Water saving



Universale
Standard



Filtro Antisabbia
Sand filter



Pulizia facile
Easy clean



Anticalcare
Anti-limestone

Realizzati in ABS e acciaio inox
Made of ABS and stainless steel
Réalisés en ABS and acier inoxydable
Hergestellt aus ABS und Edelstahl
Realizados en ABS y acero inox
Изготовлено из АБС и нержавеющей стали



Universale
Standard



Doppia aggraffatura
Double Lock



Antitorsione
Anti-Twist



Resistente alle piegature
Anti-Fold



Resistente
Resistente

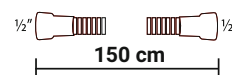

Per assistenza tecnica prendere visione della sezione RETE VENDITA nel nostro sito www.gedy.com
For technical assistance, read the SALES NETWORK section on our website www.gedy.com

Star Mix.

GEDY



Cromato
Chromed



Nero matt
Matt black



STAR MIX 01 - GYSC10301

26 x 55 x 98,5/133,5 cm

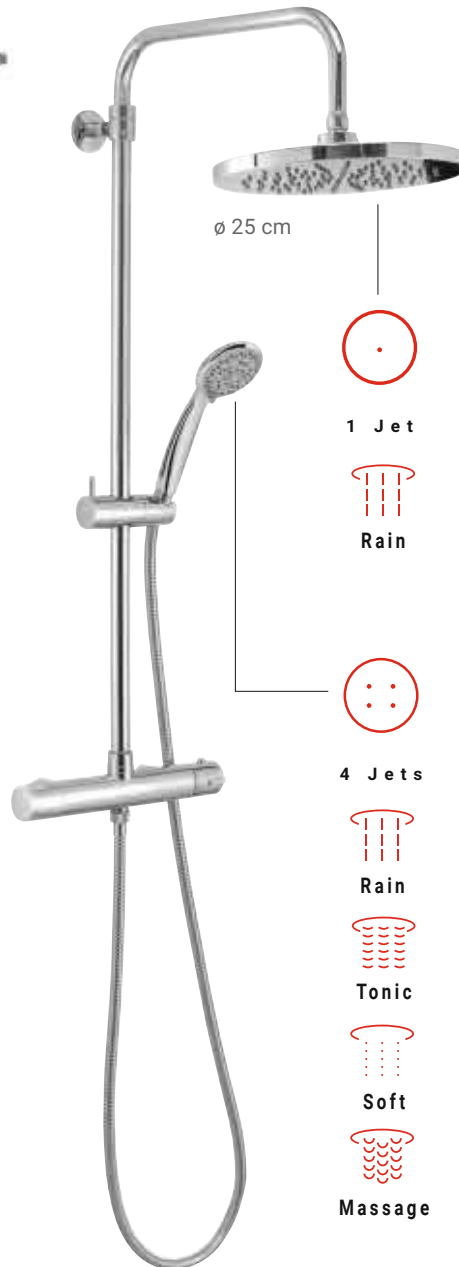

STAR MIX 00 - GYSC10300

27,5 x 50,5 x 84,5/125,5 cm



STAR MIX 03 - GYSC10303

28 x 49,3 x 83/127 cm

Easy.

GEDY



Cromato
Chromed

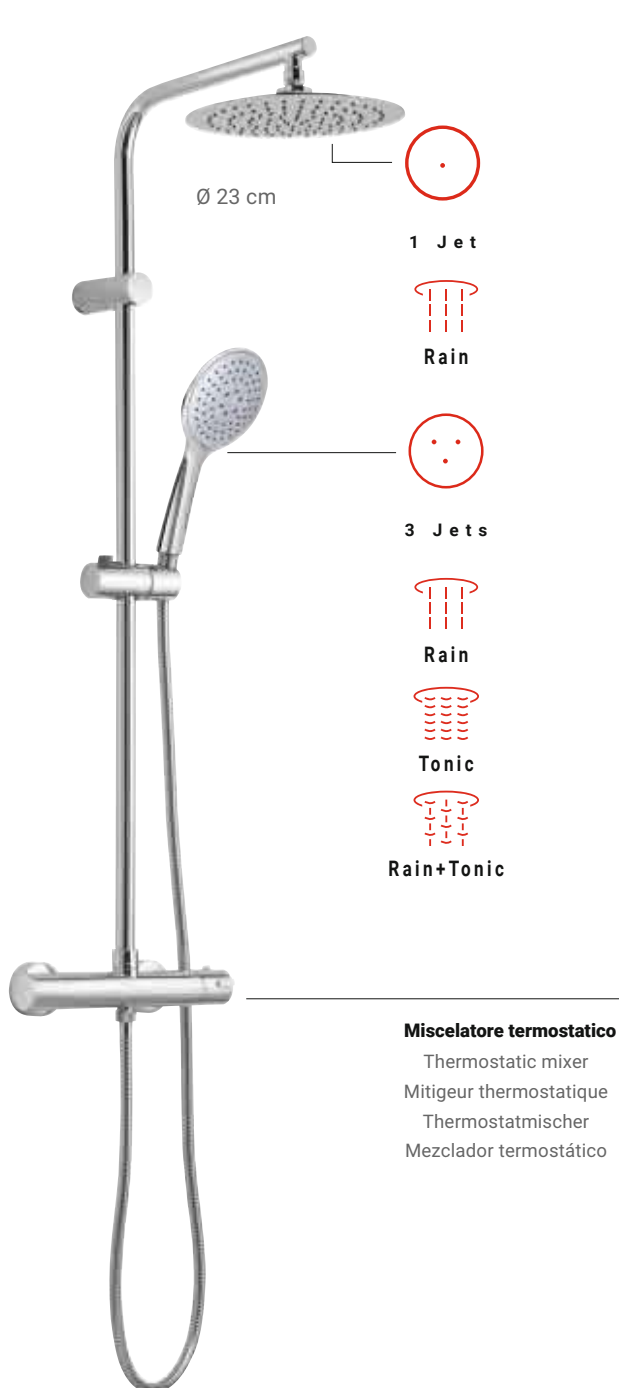

EASY MIX 02 - GYSC10102

27,5 x 46,5 x 102 cm

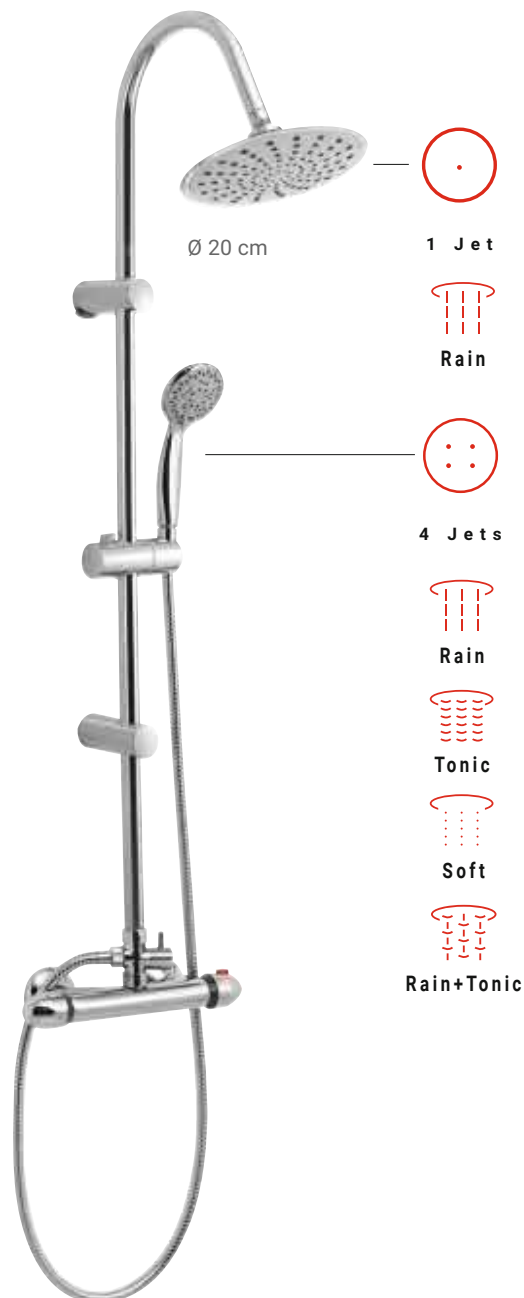

EASY MIX 01 - GYSC10101

29 x 40,5 x 108,5 cm

Star Plus.

GEDY



Cromato
Chromed



Nero matt
Matt black

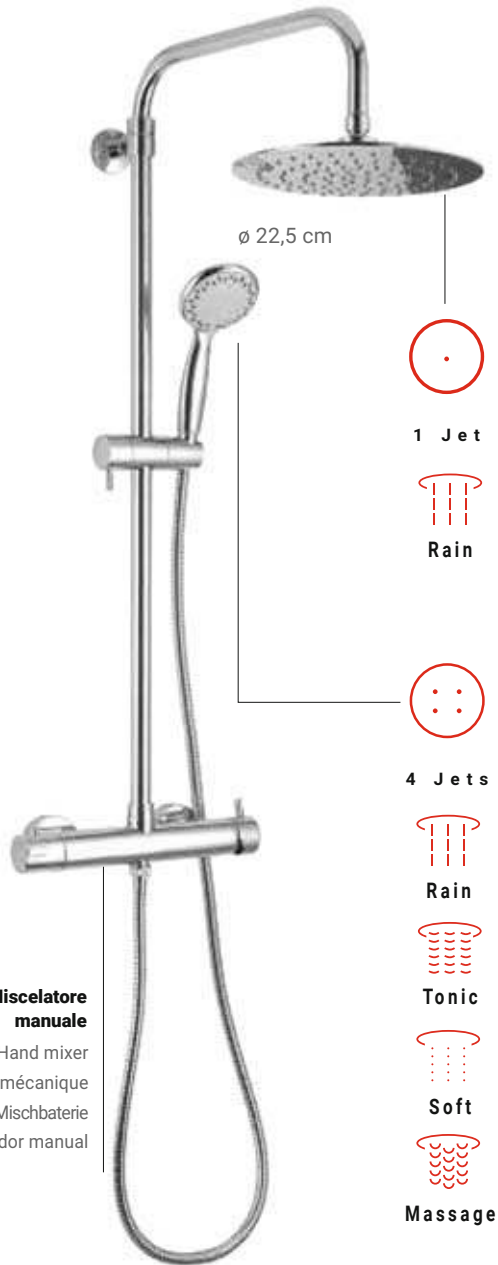

Miscelatore manuale

Hand mixer
Mitigeur mécanique
Manuelle Mischbatterie
Mezclador manual

STAR PLUS 00 - GYSC10250

20 x 55 x 80/140 cm



Miscelatore manuale

Hand mixer
Mitigeur mécanique
Manuelle Mischbatterie
Mezclador manual

STAR PLUS 01 - GYSC10251

28,8 x 49 x 84/144 cm

Tech.

GEDY



Cromato
Chromed



TECH 00 - GYSC10400

23 x 49 x 109 cm

Star.

GEDY



Cromato
Chromed



STAR 02 - GYSC10202

20 x 46 x 70 cm



STAR 01 - GYSC10201
20 x 49 x 106 cm



STAR 00 - GYSC10200
25 x 50,5 x 82,5 cm

Easy.

GEDY



Cromato
Chromed



EASY 05 - GYSC10005

20 x 41 x 100 cm

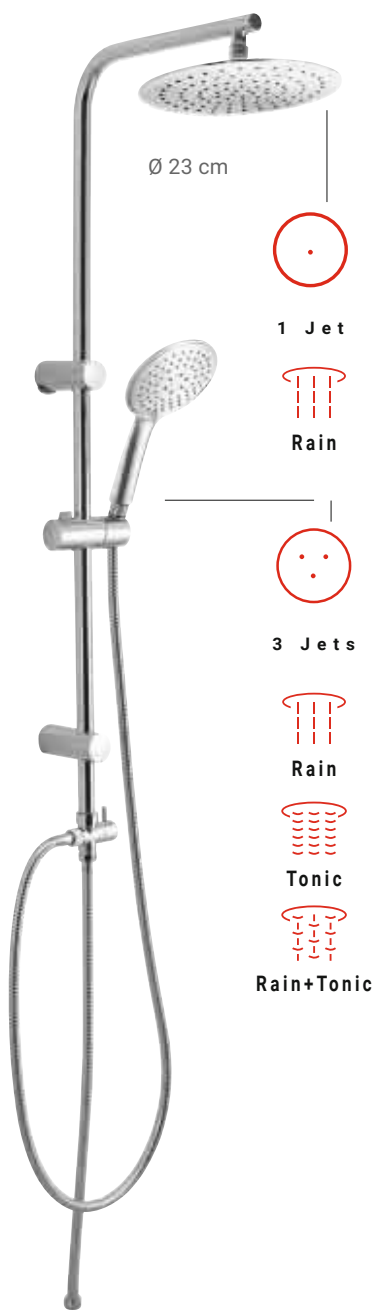

EASY 04 - GYSC10004

23 x 46 x 100 cm



EASY 03 - GYSC10003

20 x 44,5 x 100 cm

IDROTERAPIA . HYDROTHERAPY .



Cromato
Chromed



Cromato/Bianco
Chromed/White



Cromato
Chromed

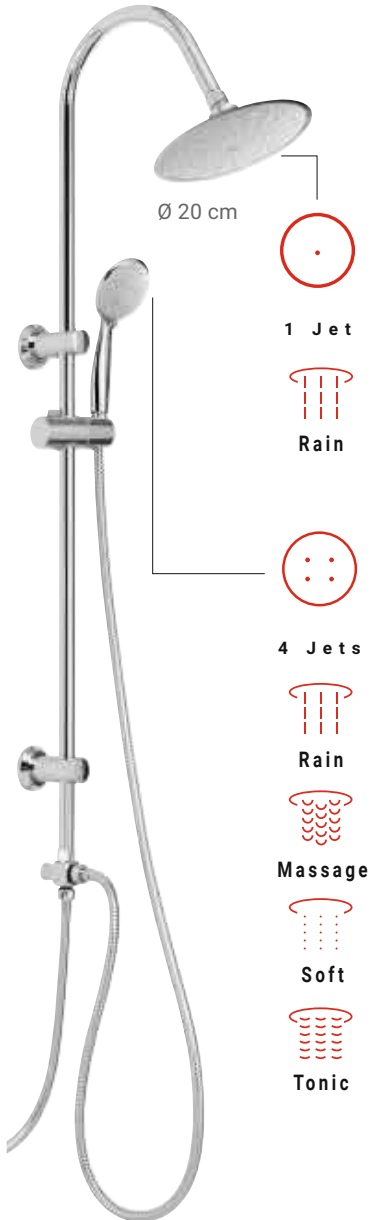

EASY 02 - GYSC10002

20 x 39 x 104 cm

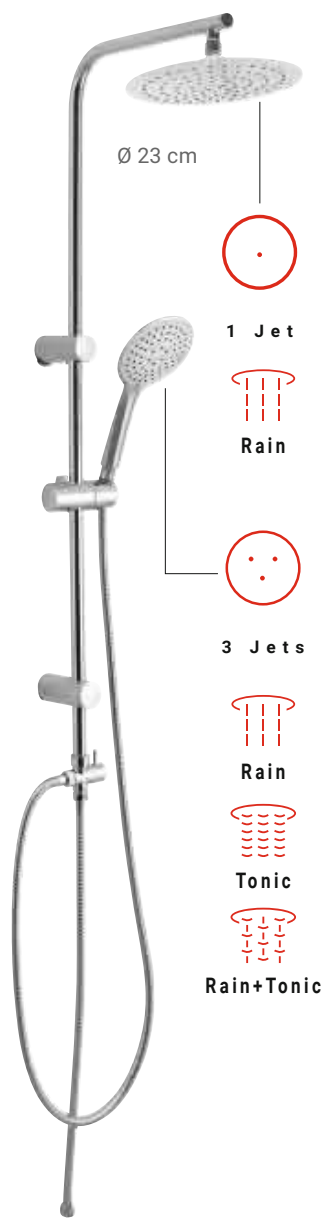

EASY 01 - GYSC10001

23 x 46 x 100 cm

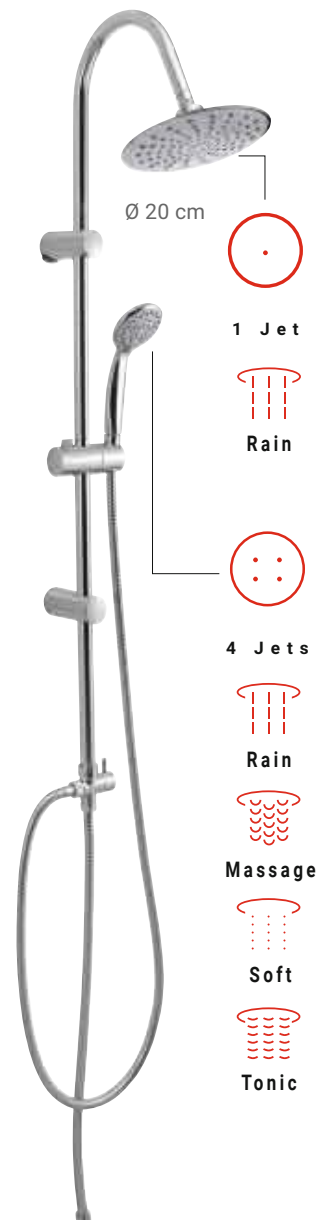

EASY 00 - GYSC10000

20 x 40,5 x 104 cm

Music.

GEDY



1 Jet



Rain



Bluetooth



Cromato/Bianco
Chromed/White



MUSIC 00 - GYSC10900

23 x 51 x 91 cm

Light.

GEDY



Cromato
Chromed



Color
change



1 Jet



Rain



3 Jets



Rain



Tonic



Rain+Tonic

LIGHT 00 - GYSC10800

20 x 45 x 100 cm



Liberty.

GEDY



1 Jet



Rain



Cromato
Chromed



LIBERTY 00 - GYSC10600

20 x 43 x 105 cm



Bronzo
Bronze



LIBERTY 01 - GYSC10601

20 x 43 x 105 cm



Rame
Copper



LIBERTY 02 - GYSC10602

20 x 43 x 105 cm



GARANZIA
WARRANTY

Pannelli doccia Shower panels

A lato dei moderni pannelli in acciaio inox in finitura spazzolata, GEDY presenta anche una collezione di pannelli doccia multifunzione in vetro temperato ultralight laccato in colorazioni abbinabili con la sua enorme gamma di accessori e complementi per il bagno.

Alongside the modern panels in stainless steel with brushed finish, GEDY also has a collection of multipurpose shower panels in ultralight tempered glass, which combine with its enormous range of accessories and complementary features for the bathroom.

Outre les panneaux modernes en acier inox dans la finition brossée, GEDY présente une collection de panneaux de douche multifonction en verre trempé ultralight laqué dans des couleurs à assortir à sa gamme considérable d'accessoires et d'éléments de décoration pour la salle de bains.

Neben den moderne Paneelen aus gebürstetem Edelstahl bietet GEDY auch eine Kollektion von Multifunktionsduschpaneelen aus utraleichem gehärtetem Glas an, lackiert in Farben, die mit der enormen Palette der Accessoires für das Bad kombiniert werden kann.

Además de los modernos paneles de acero inoxidable con acabado cepillado, GEDY presenta también una colección de paneles ducha multifunción de vidrio templado ultralight laqueado en colores combinables con su enorme gama de accesorios y complementos para el baño.

Наряду с душевыми панелями из нержавеющей стали с отделкой «эффект щетки» GEDY представляет также коллекцию душевых многофункциональных панелей из суперлегкого закаленного стекла, покрытого цветным лаком, который можно сочетать с множеством аксессуаров и дополнений для ванной.



Risparmio idrico
Water saving



Universale
Standard



Filtro Antisabbia
Sand filter



Pulizia facile
Easy clean



Anticalcare
Anti-limestone



Universale
Standard



Doppia aggraffatura
Double Lock



Antitorsione
Anti-Twist



Resistente
alle piegature
Anti-Fold



Resistent
Resistente

Realizzati in ABS, acciaio inox e ottone

Made of ABS, stainless steel and brass - Réalisés en ABS, acier inoxydable and laiton

Hergestellt aus ABS, Edelstahl und Messing - Realizados en ABS, acero inox y latón

Изготовлено из АБС, нержавеющей стали и латунь

Per assistenza tecnica prendere visione della sezione RETE VENDITA nel nostro sito www.gedy.com
For technical assistance, read the SALES NETWORK section on our website www.gedy.com

Spa.

GEDY

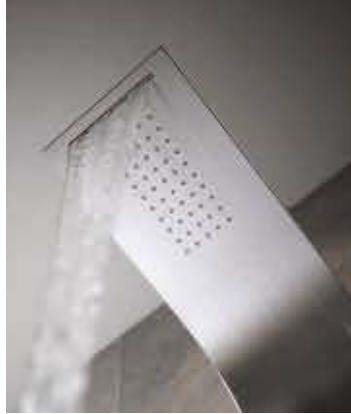

Bianco
White

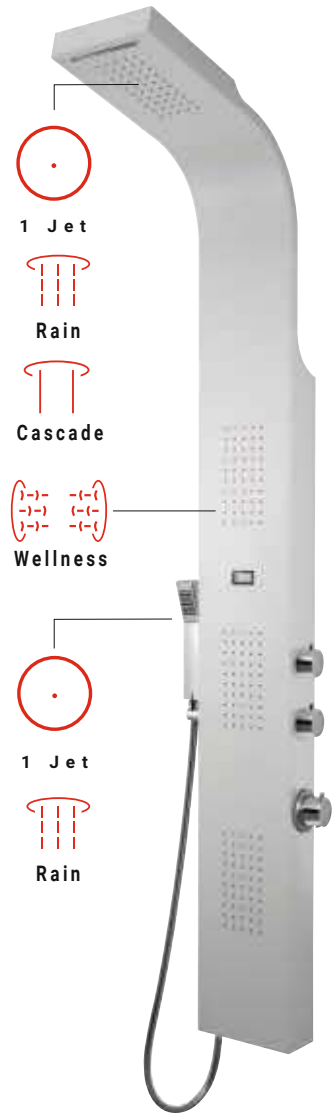

SPA 00 - GYSP10600

29 x 47 x 166 cm

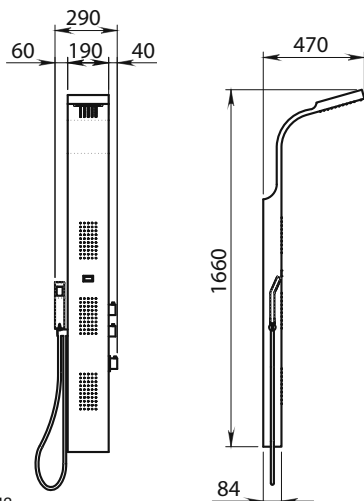

Nero
Black

SPA 01 - GYSP10601

29 x 47 x 166 cm



Inox spazzolato
Brushed stainless
steel

SPA 02 - GYSP10602

29 x 47 x 166 cm

Miscelatore termostatico

Thermostatic mixer
Mitigeur thermostatique
Thermostatmischer
Mezclador termostático
Термостатический
смеситель

Wellness.

GEDY



Nero
Black

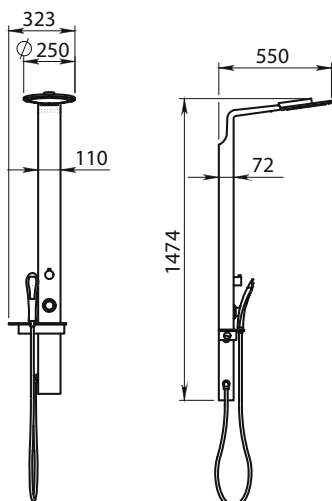
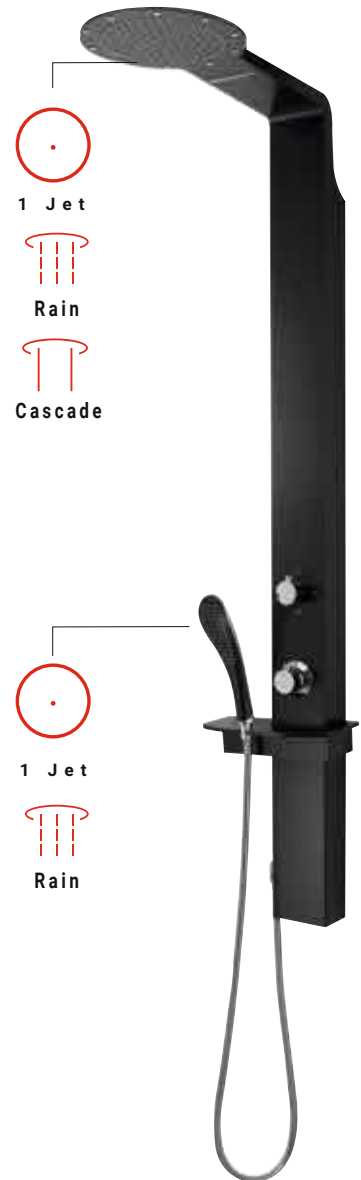

Bianco
White

WELLNESS 01 - GYSP10501

32,3 x 55 x 147,4 cm



Inox spazzolato
Brushed stainless
steel

WELLNESS 02 - GYSP10502

32,3 x 55 x 147,4 cm

WELLNESS 00 - GYSP10500

32,3 x 55 x 147,4 cm

Miscelatore termostatico

Thermostatic mixer
Mitigeur thermostatique
Thermostatmischer
Mezclador termostático
Термостатический
смеситель

Massage.

GEDY



Inox spazzolato
Brushed
stainless steel

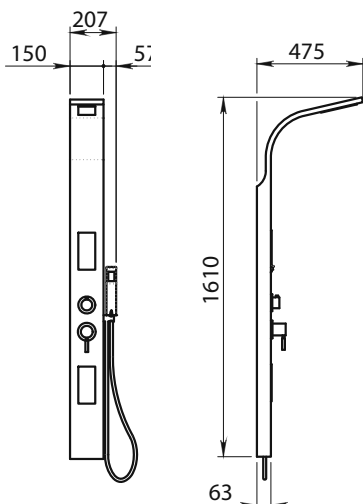
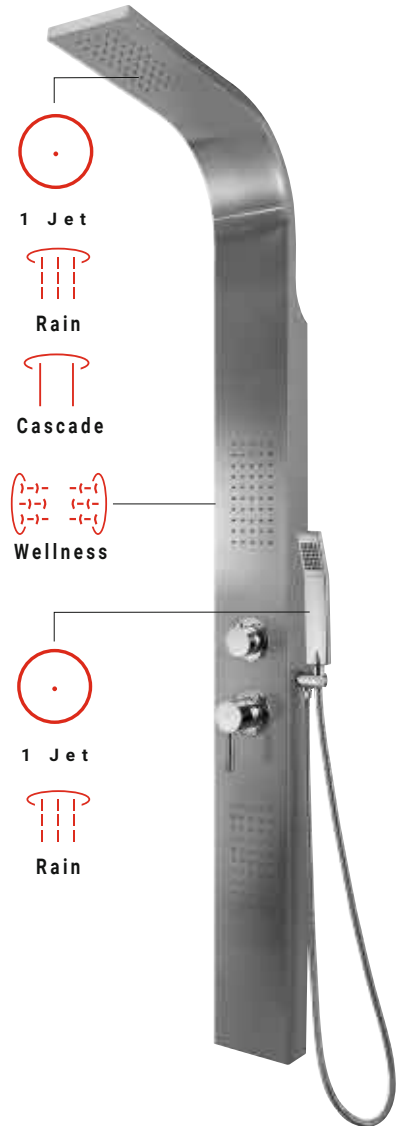

MESSAGE 01 - GYSP10401

20,7 x 47,5 x 161 cm

Miscelatore manuale

Manual mixer
Mitigeur manuel
Manueller Mischer
Mezclador manual
Ручной миксер

Cascade. Cascade Plus.

GEDY



Inox spazzolato
Brushed
stainless steel



1 Jet



Rain



Cascade

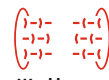

Wellness



1 Jet



Rain

Miscelatore manuale

Manual mixer
Mitigeur manuel
Manueller Mischer
Mezclador manual
Ручной миксер

CASCADE 00 - GYSP10200

18 x 50,5 x 154 cm

CASCADE PLUS 00 - GYSP10300

18 x 50,5 x 154 cm

Miscelatore termostatico

Thermostatic mixer
Mitigeur thermostatique
Thermostatmischer
Mezclador termostático
Термостатический
смеситель

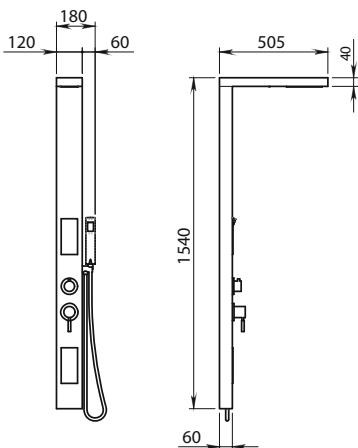

Style.

GEDY



Argento
Silver

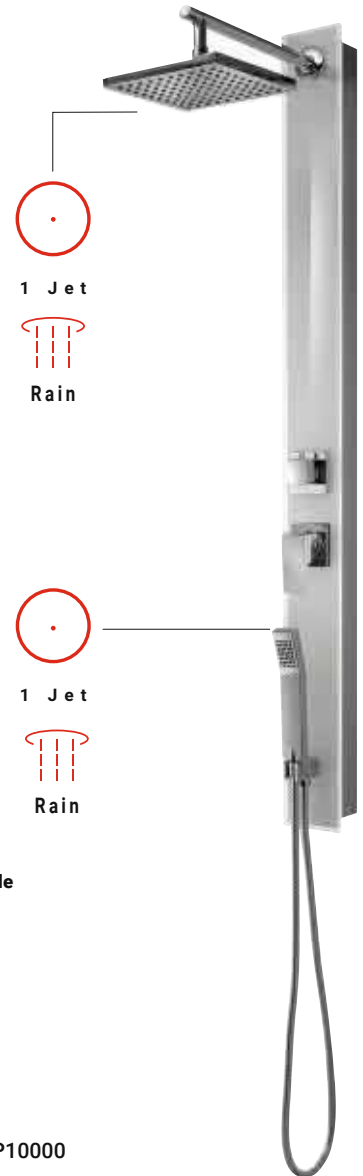

Miscelatore manuale

Manual mixer
Mitigeur manuel
Manueller Mischer
Mezclador manual
Ручной миксер

STYLE 00 - GYSP10000

20,3 x 47,9 x 130,2 cm

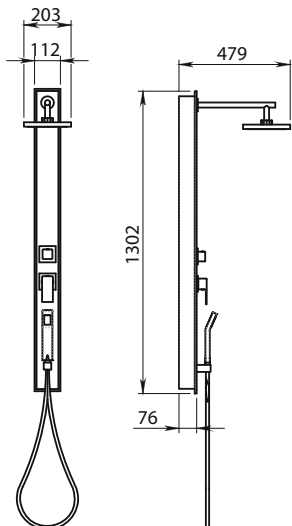

Bianco
White

STYLE 01 - GYSP10001

20,3 x 47,9 x 130,2 cm

Vetro temperato

Tempered glass
Verre tempéré
Sekuritglas
Cristal templado
закаленное стекло



GARANZIA
WARRANTY

Soffioni Shower heads

Largo ventaglio di misure, funzioni, forme e materiali per i soffioni doccia GEDY, tutti dotati di filtro antisabbia, tecnologia water saving, tettarelle che permettono una rapida rimozione manuale del calcare.

Wide range of size, functions, shapes and materials for GEDY shower heads, all with sand filter, water saving technology and nipples for easy scale removal by hand.

Vaste gamme de dimensions, de fonctions, de formes et de matériaux pour les pommes de douche GEDY, toutes munies d'un filtre anti-sable, suivant la technologie water saving, des picots qui permettent une élimination manuelle rapide du calcaire.

Neben den moderne Paneelen aus gebürstetem Edelstahl bietet GEDY auch eine Kollektion von Multifunktionsduschpaneelen aus utraleichem gehärtetem Glas an, lackiert in Farben, die mit der enormen Palette der Accessoires für das Bad kombiniert werden kann.

Große Vielfalt von Größen, Funktionen, Formen und Materialien für die Duschstrahler GEDY, alle ausgestattet mit Sandfilter, Water-Saving-Technologie und Einsatz für die schnelle Entfernung von Kalkablagerungen.

Ассортимент леек GEDY представлен богатым выбором размеров, функций, форм и материалов. Все они оснащены фильтром для задержки песка, регулятором расхода воды и легко чистящимися от скопившейся накипи соплами.



Risparmio idrico
Water saving



Universale
Standard



Filtro Antisabbia
Sand filter



Pulizia facile
Easy clean

Design.

TOP DESIGN

design Simone Micheli



Bianco
White



1 Jet



Rain



DESIGN 01 - GYSH10501

Ø 50 x 1,5 cm

Realizzato in acciaio inox AISI 304

Made of stainless steel 304 AISI

Réalisé en acier inox 304 AISI

Hergestellt aus Rostfreier Stahl 304 AISI

Realizado en acero inoxidable 304 AISI

Изготовлено из нержавеющей сталь 304 AISI

AISI
304

Top.

GEDY



1 Jet



Rain



Maggiore
pressione
del getto

Stronger jet
spray



Cromato
Chromed

Realizzato in ABS

Made of ABS

Réalisé en ABS

Hergestellt aus ABS

Realizado en ABS

Изготовлено из АБС



TOP 01 - GYSH10401

Ø 22,5 x 6 cm

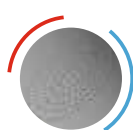

Microfori
Microholes



TOP 00 - GYSH10400

Ø 11 x 7,5 cm

Tech.

GEDY



1 Jet



Rain



**Lucido
Polished**



**AISI
304**

Realizzati in acciaio inox AISI 304 e ottone

Made of stainless steel 304 AISI and brass

Réalisé en acier inox 304 AISI et laiton

Hergestellt aus Rostfreier Stahl 304 AISI und Messing

Realizado en acero inoxidable 304 AISI y latón

Изготовлено из нержавеющей сталь 304 AISI и латунь



TECH 10 - GYSH10310

10 x 10 x 5 cm



TECH 11 - GYSH10311

Ø 10 x 5 cm

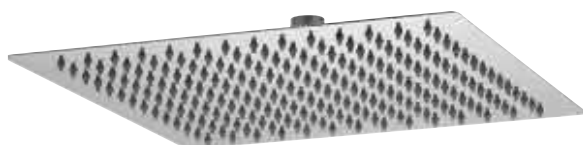

TECH 09 - GYSH10309

50 x 50 x 5 cm



TECH 07 - GYSH10307

40 x 40 x 5 cm



TECH 01 - GYSH10301

30 x 30 x 5 cm



TECH 05 - GYSH10305

25 x 25 x 5 cm



TECH 03 - GYSH10303

20 x 20 x 5 cm



TECH 08 - GYSH10308

Ø 50 x 5 cm

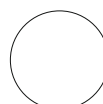

TECH 06 - GYSH10306

Ø 40 x 5 cm



TECH 00 - GYSH10300

Ø 30 x 5 cm



TECH 04 - GYSH10304

Ø 25 x 5 cm



TECH 02 - GYSH10302

Ø 20 x 5 cm



IDROTERAPIA . HYDROTHERAPY .

Star.

GEDY



1 Jet



Rain



Cromato
Chromed

Realizzato in acciaio inox, ottone e ABS

Made of stainless steel, brass and ABS

Réalisé en acier inox, laiton et ABS

Hergestellt aus Edelstahl, Messing und ABS

Realizado en acero inox, latón y ABS

Изготовлено из нержавеющей сталь, латунь и АБС



STAR 05 - GYSH10205

Ø 20 x 5 cm



STAR 04 - GYSH10204

Ø 25 x 6 cm

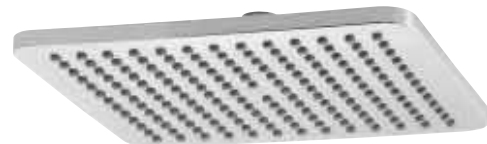

STAR 02 - GYSH10202

25 x 25 x 6 cm

Plus.

GEDY



1 Jet



Rain



Nero matt
Matt black

Realizzato in ottone e ABS

Made of brass and ABS

Réalisé en laiton et ABS

Hergestellt aus Messing und ABS

Realizado en latón y ABS

Изготовлено из латунь и АБС



PLUS 07 - GYSH10107

Ø 22,5 x 5 cm

Realizzato in acciaio inox, ottone e ABS

Made of stainless steel, brass and ABS

Réalisé en acier inox, laiton et ABS

Hergestellt aus Edelstahl, Messing und ABS

Realizado en acero inox, latón y ABS

Изготовлено из нержавеющей сталь, латунь и АБС



1 Jet



Rain



Nichel spazzolato
Brushed nickel



PLUS 06 - GYSH10106

Ø 23 x 5 cm



Cromato/Bianco
Chromed/White



PLUS 04 - GYSH10104

Ø 22,6 x 5,6 cm



Cromato
Chromed



PLUS 05 - GYSH10105

Ø 23 x 5 cm



Cromato
Chromed



PLUS 03 - GYSH10103

20 x 20 x 6,5 cm



Cromato
Chromed



PLUS 02 - GYSH10102

Ø 20 x 6,9 cm



Cromato
Chromed



PLUS 01 - GYSH10101

Ø 20 x 5,4 cm



Cromato
Chromed

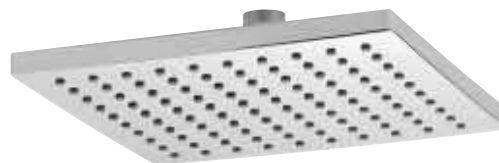

PLUS 00 - GYSH10100

20 x 20 x 5 cm

Easy.

GEDY



Cromato
Chromed

Realizzato in acciaio inox, ottone e ABS

Made of stainless steel, brass and ABS

Réalisé en acier inox, laiton et ABS

Hergestellt aus Edelstahl, Messing und ABS

Realizado en acero inox, latón y ABS

Изготовлено из нержавеющей сталь, латунь и АБС



EASY 04 - GYSH10004

Ø 10 x 8,5 cm



5 Jets



Rain



Tonic



Massage



Rain+Tonic



Rain+Massage



1 Jet



Rain



EASY 03 - GYSH10003

Ø 10,2 x 6,5 cm



EASY 01 - GYSH10001

Ø 7 x 10,5 cm



EASY 00 - GYSH10000

Ø 7,2 x 9,5 cm

Light.

GEDY



1 Jet



Rain



Cromato
Chromed

Realizzato in acciaio inox, ottone e ABS

Made of stainless steel, brass and ABS

Réalisé en acier inox, laiton et ABS

Hergestellt aus Edelstahl, Messing und ABS

Realizado en acero inox, latón y ABS

Изготовлено из нержавеющей сталь, латунь и АБС



LIGHT 03 - GYSH10703

Ø 25 x 8 cm



Color
change



LIGHT 00 - GYSH10700

Ø 20,5 x 8 cm



Color
change

Liberty.

GEDY



1 Jet



Rain

Realizzato in acciaio inox, ottone e ABS

Made of stainless steel, brass and ABS

Réalisé en acier inox, laiton et ABS

Hergestellt aus Edelstahl, Messing und ABS

Realizado en acero inox, latón y ABS

Изготовлено из нержавеющей сталь, латунь и АБС



Cromato
Chromed



LIBERTY 00 - GYSH10600

Ø 20,5 x 10,8 cm



Bronzo
Bronze



LIBERTY 01 - GYSH10601

Ø 20,5 x 10,8 cm



Rame
Copper



LIBERTY 02 - GYSH10602

Ø 20,5 x 10,8 cm

Music.

GEDY



1 Jet



Rain



Cromato/Bianco
Chromed/White



Bluetooth



MUSIC 00 - GYSH11100

Ø 23 x 9 cm



GARANZIA
WARRANTY

Flessibili Hoses

**Tutti dotati di attacco universale 1/2" e di doppia aggraffatura,
i flessibili GEDY sono presentati in un ampio ventaglio di materiali, finiture e misure disponibili.**

All complete with universal 1/2" fitting and dual crimping.
GEDY hoses are available in a wide range of materials, finishes and sizes.

Tous munis d'un raccord universel de 1/2 pouces et d'un double agrafage, les tuyaux flexibles GEDY sont présentés dans une vaste gamme de matériaux, de finitions et de dimensions.

Alle ausgestattet mit Universalanschluss 1/2" und doppelter Rändelung: die Schläuche GEDY werden in einer Vielzahl von Materialien, Verarbeitungen und Größen angeboten.

Todos dotados de conexión universal 1/2" y de engrapado doble, los flexos GEDY están disponibles con un amplio abanico de materiales, acabados y medidas.

Все шланги GEDY в двойной оплетке и имеют универсальное соединение 1 / 2", в наличии большой выбор материалов, отделок и размеров.



Risparmio idrico
Water saving



Universale
Standard



Antitorsione
Anti-Twist



Resistente
alle piegature
Anti-Fold



Resistent
Resistente

Brass.

GEDY



Doppia aggraffatura
Double Lock



Cromato
Chromed

Realizzato in ottone

Made of brass
Réalisé en laiton
Hergestellt aus Messing
Realizado en latón
Изготовлено из латунь

BRASS 04 - GYFX10004

Ø 1,4 x 150 - 200 cm

Black Plus.

GEDY



Nero matt
Matt black



BLACK PLUS 01 - GYFX10901

Ø 1,4 x 200 cm

BLACK PLUS 00 - GYFX10900

Ø 1,4 x 150 cm

Black.

GEDY



Nero matt
Matt black



BLACK 01 - GYFX10801

Ø 1,4 x 200 cm

BLACK 00 - GYFX10800

Ø 1,4 x 150 cm

Silver.

GEDY



Argento
Silver



SILVER 01 - GYFX10701

Ø 1,4 x 200 cm

SILVER 00 - GYFX10700

Ø 1,4 x 150 cm

Super Black.

GEDY



Cromato/Nero
Chromed/Black

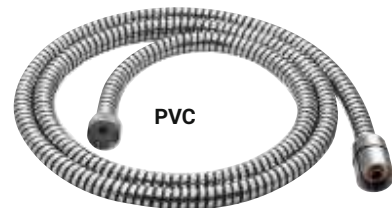

SUPER BLACK 01 - GYFX10601

Ø 1,4 x 200 cm

SUPER BLACK 00 - GYFX10600

Ø 1,4 x 150 cm

Super White.

GEDY



Cromato/Bianco
Chromed/White

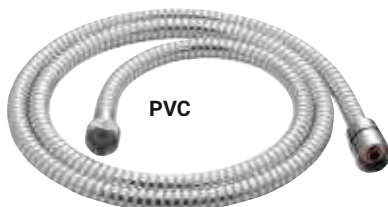

SUPER WHITE 01 - GYFX10501

Ø 1,4 x 200 cm

SUPER WHITE 00 - GYFX10500

Ø 1,4 x 150 cm

Double White.

GEDY



Cromato/Bianco
Chromed/White



DOUBLE WHITE 01 - GYFX10301

Ø 1,4 x 200 cm

DOUBLE WHITE 00 - GYFX10300

Ø 1,4 x 150 cm

Inox.

GEDY

Realizzato in acciaio inox, ottone e PVC

Made of stainless steel, brass and PVC - Réalisé en acier inox, laiton et PVC - Hergestellt aus Edelstahl, Messing und PVC - Realizado en acero inox, latón y PVC - Изготовлено из нержавеющей сталь, латунь и PVC



Cromato
Chromed



INOX 13 - GYFX10113

Ø 1,4 x 60 cm



Inox spazzolato
Brushed steel



INOX 12 - GYFX10112

Ø 1,4 x 200 cm



INOX 11 - GYFX10111

Ø 1,4 x 150 cm



Bronzo
Bronze



INOX 06 - GYFX10106

Ø 1,4 x 200 cm



Rame
Copper



INOX 08 - GYFX10108

Ø 1,4 x 200 cm



Doppia aggraffatura
Double Lock

INOX 05 - GYFX10105

Ø 1,4 x 150 cm



Doppia aggraffatura
Double Lock

INOX 07 - GYFX10107

Ø 1,4 x 150 cm



Cromato
Chromed



INOX 04 - GYFX10104

Ø 1,4 x 150 - 200 cm



Cromato
Chromed



INOX 03 - GYFX10103

Ø 1,4 x 200 cm



Doppia aggraffatura
Double Lock



Doppia aggraffatura
Double Lock

INOX 02 - GYFX10102

Ø 1,4 x 150 cm



Cromato
Chromed



INOX 01 - GYFX10101

Ø 1,4 x 200 cm

INOX 00 - GYFX10100

Ø 1,4 x 150 cm

Realizzato in acciaio inox e ottone

Made of stainless steel and brass

Réalisé en acier inox et laiton

Hergestellt aus Edelstahl und Messing

Realizado en acero inox y latón

Изготовлено из нержавеющей сталь и латунь



GARANZIA
WARRANTY

Accessori Accessories

Varie possibilità di sostituzione di accessori e particolari per la zona doccia, dai supporti per le doccette e i saliscendi, ai kit per la sostituzione areatori in varie misure, alle prese d'acqua, deviatori e braccetti con connessione universale.

A host of replacement possibilities for accessories and details for the shower area, from brackets to sliding bars, kits for aerator replacement in different sizes, water inlets, deflectors and brackets with universal connection.

Différentes possibilités de remplacement d'accessoires et de pièces pour la zone douche : supports de douchette, barres de douche, kits pour le remplacement des aérateurs dans différentes dimensions, prises d'eau, déviateurs et bras avec connexion universelle.

Erschiedene Möglichkeiten der Ersetzung von Zubehör- und Ersatzteile im Duschenbereich, von den Handduschenhalterungen zu den Wandschienen und von den Kits für die Ersetzung der Lüfter in verschiedenen Größen zu den Wasseranschlüssen, Umleitern und Armen mit Universalanschluss.

Varias posibilidades de sustitución de accesorios y detalles para la zona ducha, desde los soportes para los mangos de ducha y los soportes deslizantes, los kits para la sustitución aireadores de varias medidas, hasta las toma de agua, los desviadores y los brazos con conexión universal.

Богатый ассортимент аксессуаров и дополнений для душа, начиная от держателей для ручных душей и штанг до наборов для смены аэракторов различных размеров, соединений для подвода воды, девиаторов и держателей с универсальным креплением.



Universale
Standard

Realizzati in ABS, acciaio inox e ottone

Made of ABS, stainless steel and brass

Réalisés en ABS, acier inoxydable and laiton

Hergestellt aus ABS, Edelstahl und Messing

Realizados en ABS, acero inox y latón

Изготовлено из АБС, нержавеющей стали и латунь

Bar Liberty.

GEDY



Cromato
Chromed

ø 2,5 cm

BAR LIBERTY 00 - GYAC10300

8 x 16 x 74 cm



Bronzo
Bronze

ø 2,5 cm

BAR LIBERTY 01 - GYAC10301

8 x 16 x 74 cm



Rame
Copper

ø 2,5 cm

BAR LIBERTY 02 - GYAC10302

8 x 16 x 74 cm

Bar Tendance.

GEDY



Cromato/Bianco
Chromed/White



ø 2,5 cm

BAR TENDENCE 02
GYAC10202
13,5 x 20 x 81 cm



Cromato/Nero
Chromed/Black



ø 2,5 cm

BAR TENDENCE 03
GYAC10203
13,5 x 20 x 81 cm



Bianco
White



BAR TENDENCE 00
GYAC10200
12 x 7,5 x 66 cm



Nero
Black



BAR TENDENCE 01
GYAC10201
12 x 7,5 x 66 cm

Bar Star.

GEDY



Cromato
Chromed



ø 2,5 cm

BAR STAR 00
GYFX10100
12,4 x 7,3 x 75 cm



Cromato
Chromed



ø 2,5 cm

BAR STAR 01
GYAC10101
11 x 7,2 x 75,5-87 cm



Nichel spazzolato
Brushed nickel



ø 2,5 cm

BAR STAR 02
GYAC10102
11 x 7,2 x 75,5-87 cm



Lucido
Polished



ø 1,9 cm

BAR EASY 00
GYAC10000
11,6 x 8 x 60,5 cm

Bar Easy.

GEDY

Slider.

GEDY



Cromato
Chromed



SLIDER 04 - GYAC99004

11,3 x 3,6 x 3,6 cm



SLIDER 01 - GYAC99001

11,6 x Ø 3,7 cm

**Idoneo per
aste Ø 19 mm**
Suitable for
shower rails Ø 19 mm



SLIDER 03 - GYAC99003

11 x Ø 4 cm



SLIDER 00 - GYAC99002

12 x Ø 4 cm

Supporti doccetta universali per asta saliscendi

Universal head shower supports for sliding rail

**Idoneo per
aste Ø 25 mm**

Suitable for
shower rails Ø 25 mm

**con riduttori
Ø 18 - 25 mm**

with reducers
Ø 18 - 25 mm

Clip Liberty.

GEDY



Cromato
Chromed

ABS



CLIP LIBERTY 04

GYAC10804

Ø 6 x 10 cm



Cromato
Chromed

Cromall®



CLIP LIBERTY 00

GYAC10800

Ø 6 x 10 cm



Rame
Copper



CLIP LIBERTY 02

GYAC10802

Ø 6 x 10 cm

Supporto doccia mobile

Mobile shower bracket

Clip Tech.

GEDY



Cromato
Chromed

ABS



CLIP TECH 00

GYAC10700

9 x 7 x 4,2 cm

Supporto doccia mobile

Mobile shower bracket

Clip Star.

GEDY



Cromato
Chromed



CLIP STAR 00

GYAC10600

7,1 x 10,2 x 3,4 cm

Supporto doccia mobile

Mobile shower bracket

ABS

Clip Plus.

GEDY



Nichel
spazzolato
Brushed nickel



Cromato/Nero
Chromed/Black



Cromato/Bianco
Chromed/White



Cromato/Grigio
Chromed/Grey



CLIP PLUS 03

GYAC10503

4,2 x 6,5 x 5,8 cm



CLIP PLUS 02

GYAC10502

4,2 x 6,5 x 5,8 cm



CLIP PLUS 01

GYAC10501

4,2 x 6,5 x 5,8 cm



CLIP PLUS 00

GYAC10500

4,2 x 6,5 x 5,8 cm

ABS

Supporto doccia mobile

Mobile shower bracket

Clip Easy.

GEDY



Cromato
Chromed

ABS

Supporto doccia fisso con ventosa

Suction cup fixed shower bracket

2 posizioni

2 positions



CLIP EASY 02

GYAC10402

Ø 9,6 x 6 x 8,6 cm



Con ventosa
With suction
cup

Solo su superfici lisce
(specchi, piastrelle)
For flat surfaces
(mirrors, tiles) only

1 posizione

1 position



CLIP EASY 01

GYAC10401

Ø 6 x 6,8 cm

Supporto doccetta fisso

Fixed shower bracket

Connessione universale

Universal connection



CLIP EASY 00

GYAC10400

Ø 4 x 5 cm

Oxy Mix Clip.

GEDY

Preso acqua con rubinetto d'arresto con supporto
Water inlet with on-off mixer and support

Cromato
Chromed



Ottone
Brass

OXY MIX CLIP 04 - GYAC11604

9,5 x 6,8 x 5,4 cm



OXY MIX CLIP 03 - GYAC11603

9,8 x 7 x 6,5 cm

Oxy Mix.

GEDY

Preso acqua con rubinetto d'arresto
Water inlet with on-off mixer

Cromato
Chromed



Ottone
Brass

OXY MIX 02 - GYAC11602

5 x 7,6 x 5,2 cm



OXY MIX 01 - GYAC11601

6 x 7,2 x 5,2 cm

Oxy Clip Plus.

GEDY

Preso acqua con supporto
Water inlet with support

Cromato
Chromed



Ottone
Brass

OXY CLIP PLUS 00 - GYAC11400

4 x 8,5 x 5,5 cm

GEDY

Preso acqua con supporto
Water inlet with support

Nero matt
Matt black



Ottone
Brass

NEW

OXY CLIP PLUS 01 - GYAC11401

4 x 8,5 x 5,5 cm

Oxy Clip Easy.

GEDY

Preso acqua con supporto
Water inlet with support

Cromato
Chromed



Ottone
Brass

OXY CLIP EASY 00 - GYAC11300

4 x 8 x 5,8 cm

GEDY

Preso acqua con supporto
Water inlet with support

Nero matt
Matt black



Ottone
Brass

NEW

OXY CLIP EASY 01 - GYAC11301

4 x 8 x 5,8 cm

Oxy Tech.

GEDY



Cromato
Chromed



Presacqua
Water inlet

Ottone
Brass

OXY TECH 00 - GYAC11200

4,7 x 6 x 5 cm

Oxy Star.

GEDY



Cromato
Chromed



Presacqua
Water inlet

Ottone
Brass

OXY STAR 00 - GYAC11100

5 x 6 x 5 cm

Oxy Plus.

GEDY

Presacqua
Water inlet



Nichel
spazzolato
Brushed nickel



Rame
Copper



Bronzo
Bronze



Cromato
Chromed

Ottone
Brass



OXY PLUS 03
GYAC11003

5 x 5,5 x 6,5 cm



OXY PLUS 02
GYAC11002

5 x 5,5 x 6,5 cm



OXY PLUS 01
GYAC11001

5 x 5,5 x 6,5 cm



OXY PLUS 00
GYAC11000

5 x 5,5 x 6,5 cm

Oxy Easy.

GEDY

Presacqua
Water inlet



Nichel
spazzolato
Brushed nickel



Rame
Copper



Bronzo
Bronze



Cromato
Chromed

Ottone
Brass



OXY EASY 03
GYAC10903

6 x 7 x 3,7 cm



OXY EASY 02
GYAC10902

6 x 7 x 3,7 cm



OXY EASY 01
GYAC10901

6 x 7 x 3,7 cm



OXY EASY 00
GYAC10900

6 x 7 x 3,7 cm



Cromato
Chromed



OXY EASY 05
GYAC10905

6 x 7 x 3,7 cm



Cromato
Chromed



OXY EASY 04
GYAC10904

6,2 x 4,8 x 5,2 cm

ABS

Soap Easy.

GEDY

da \varnothing 18 a 25 mm
from \varnothing 18 to 25 mm



ABS



Portasapone per saliscendi doccia
Soap holder for sliding bar

SOAP EASY 00
GYAC11700
8,1 x 16,6 x 3,5 cm

Soapy Star.

GEDY

da \varnothing 18 a 25 mm
from \varnothing 18 to 25 mm



ABS



Mensola per saliscendi e colonna doccia
Shelf for shower bar and shower column

SOAP STAR 00
GYAC11800
25 x 9,6 x 3,2 cm

Cross Trendy.

GEDY

2 vie - 2-way



Cromato
Chromed

Ottone
Brass



Deviatore acqua per colonna doccia
Water diverter for shower column

CROSS TRENDY 00
GYAC12000
6 x 3 x 6,2 cm

Cross Easy.

GEDY



Cromato
Chromed

Universale
Universal

2 vie a cartuccia
2-way cartridge



CROSS EASY 00 - GYAC11900
6,5 x 2,8 x 6,5 cm

Ottone
Brass

2 vie
2-way

ABS



CROSS EASY 05 - GYAC11905
6,5 x 2,5 x 6,5 cm



CROSS EASY 04 - GYAC11904
7 x 2,3 x 7,5 cm

Tube Liberty.

GEDY

Acciaio inox
Stainless steel



TUBE LIBERTY 00 - GYAC13800

5,2 x 31,5 x 28,6 cm



TUBE LIBERTY 01 - GYAC13801

5,2 x 31,5 x 28,6 cm



TUBE LIBERTY 02 - GYAC13802

5,2 x 31,5 x 28,6 cm

Tube Top.

GEDY

Acciaio inox AISI 304
AISI 304 stainless steel

100 %
AISI
304



TUBE TOP 45 00 - GYAC13700

5,9 x 47,5 x 5,9 cm

TUBE TOP 35 00 - GYAC13500

3,5 x 35 x 1,5 cm

TUBE TOP 40 00 - GYAC13600

5,9 x 42,4 x 5,9 cm

TUBE TOP 30 00 - GYAC13400

3,5 x 30 x 1,5 cm

Tube Tech.

GEDY

Ottone
Brass



TUBE TECH 35 00 - GYAC13200

6 x 37,5 x 9 cm

TUBE TECH 30 00 - GYAC13100

6 x 32,5 x 9 cm

TUBE TECH 25 00 - GYAC13000

6 x 27,5 x 9 cm

Tube Trendy.

GEDY

Ottone
Brass



TUBE TRENDY 15 00 - GYAC12500

2,5 x 2,5 x 15 cm

Tube Plus.

GEDY

Acciaio inox
Stainless steel



Nichel spazzolato
Brushed nickel

TUBE PLUS 15 00 - GYAC12300

Ø 6 x 15 cm

TUBE PLUS 6 03 - GYAC12203

Ø 2 x 6 cm

Tube Star.

GEDY

Acciaio inox
Stainless steel



Cromato
Chromed

TUBE STAR 40 00 - GYAC12900

Ø 5,5 x 41,5 x 11,5 cm

TUBE STAR 30 00 - GYAC12700

Ø 5,5 x 30 x 11,5 cm

TUBE STAR 35 00 - GYAC12800

Ø 5,5 x 35 x 11,5 cm

TUBE STAR 25 00 - GYAC12600

Ø 5,5 x 26 cm x 11,5 cm



Nero matt
Matt Black



TUBE STAR 35 04 - GYAC12804

Ø 5,5 x 35 x 11,5 cm



Nichel spazzolato
Brushed nickel



TUBE STAR 35 03 - GYAC12803

Ø 5,5 x 35 x 11,5 cm



Rame
Copper



TUBE STAR 35 02 - GYAC12802

Ø 5,5 x 35 x 11,5 cm



Bronzo
Bronze



TUBE STAR 35 01 - GYAC12801

Ø 5,5 x 35 x 11,5 cm

Tube Easy.

GEDY

Acciaio inox
Stainless steel



Cromato
Chromed

TUBE EASY 00 - GYAC12100

Ø 2 x 15 cm

Spray Tech.

GEDY

Ottone
Brass



Cromato
Chromed



SPRAY TECH 01 - GYAC99301

6,2 x 12,4 x 2,2 cm



SPRAY TECH 00 - GYAC99300

5,8 x 12,4 x 2,2 cm

Doccetta shut-off
Shut-off hand shower



GARANZIA
WARRANTY

Idraulica Taps accessories

Accessoires de robinet - Wasserzähler-Zubehör
Accesorios de fontanería - Сантехнические принадлежности

Flexy.

GEDY

PVC e Acciaio inox
PVC and Stainless steel



Cromato
Chromed



FLEXY 03 - GHHY10003

Ø 3 x 6 cm

Tubo con areatore per miscelatore lavello cucina - Connessione universale

Pipe with aerator for kitchen sink mixer - Universal connection



Bianco
White



FLEXY 00 - GHHY10000

Ø 3 x 15 cm



FLEXY 01 - GHHY10001

Ø 3 x 9 cm

Water Saving.

GEDY

Riduttore di portata d'acqua
Flow reducer

ABS e Ottone
ABS and Brass



Cromato
Chromed



WATER SAVING 02

GHHY10402

Ø 3 x 4,2 cm



WATER SAVING 01

GHHY10401

Ø 2,2 x 2 cm

Joint.

GEDY

Snodo per bidet con areatore
Joint for bidet with aerator

Ottone e Acciaio inox
Brass and Stainless steel



Cromato
Chromed



JOINT 01

GHHY10501

Ø 2,5 x 4,5 cm



JOINT 00

GHHY10500

Ø 2,5 x 4,5 cm

Aerator.

GEDY

Gomma, acciaio inox e ottone
Rubber, stainless steel and brass



Cromato
Chromed



AERATOR 01
GHHY10701
Ø 2,2 x 1 cm

Key.

GEDY

Chiavetta per aeratori
Aerator key

ABS



KEY 00
GHHY10600
5 x 2 x 8 cm

Funny.

GEDY



**Non compatibile
per le vasche da bagno**
Not fitting for bath tubs



**Antivandalo
Vandal-Pro**



**Con magnete
With magnet**



**Anti ossidazione
Anti oxidation**



**Cover intercambiabile
Interchangeable cover**



**Sistema H-Look
H-Look system**



FUNNY - GHHY20000

**Tappo universale per lavabo e bidet
con cover intercambiabili e magnetiche
resine termoplastiche e metallo**

Universal washbasin and bidet plug
with interchangeable, magnetic covers
thermoplastic resins and metal

Clapet universel pour bonde de lavabo et bidet
avec bouchons magnétiques interchangeables
thermoplastique et métal

Universalstöpsel für Waschbecken und Bidet
mit austauschbaren und magnetischen Covers
Kunststoff und Metall

Tapón universal para lavabo y bidet
con tapas intercambiables y magnéticas
resina termoplásticas y metal

Универсальная пробка для раковины и
биде со сменными магнитными крышками
термопластиченых смол и металл



Cover assortite Ø 3,8/Ø 6,3 cm

Assorted covers Ø 3,8/Ø 6,3 cm

Bouchons assortis Ø 3,8/Ø 6,3 cm

Cover-Sortiment Ø 3,8/Ø 6,3 cm

Diferentes modelos de tapas Ø 3,8/Ø 6,3 cm

Крышки в ассортименте Ø 3,8/Ø 6,3 cm



REVO



**reddot award 2016
winner**



C O N T R A C T





CONTRACT.

Distributori di sapone e gel igienizzante

Dispensers for soap and sanitizer gel - Distributeurs de savon et gel désinfectant
Spender für Seife und für Desinfektiongel

Dosificadores de jabón y gel desinfectante - Диспенсеры для мыла и Гель-антисептик



Giava.

TOP DESIGN

Vetro e Cromall®
Glass and Cromall®
Verre et Cromall®
Glas und Cromall®
Cristal y Cromall®
Стекло и Cromall®

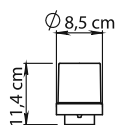

G081

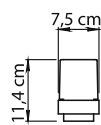

G082



13
Cromato
Chromed



Eco-Friendly
& Antigoccia
Eco-Friendly
& Drop Free

A681 Maldive.

TOP DESIGN

Ottone, Cromall® e Tritan™
 Brass, Cromall® and Tritan™
 Laiton, Cromall® et Tritan™
 Messing, Cromall® und Tritan™
 Latón, Cromall® y Tritan™
 Латунь, Cromall® и Tritan™

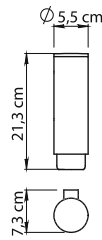

Struttura
antivandalo
Vandal-Pro
of structure

Eco-Friendly
& Antigoccia
Eco-Friendly
& Drop Free

13
Cromato
Chromed

G180 Zanzibar.

NEW

TOP DESIGN

ABS, Cromall® e acciaio inox
 ABS, Cromall® and stainless steel
 ABS, Cromall® et acier inox
 ABS, Cromall® und Edelstahl
 ABS, Cromall® y acero inox
 АБС, Cromall® и нержавеющей сталь

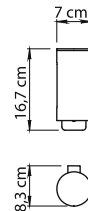

13
Cromato
Chromed

Struttura
antivandalo
Vandal-Pro
of structure

Eco-Friendly
& Antigoccia
Eco-Friendly
& Drop Free

2295 Bonito.

TOP DESIGN

Distributore touchless di sapone o gel igienizzante

Touchless dispenser for soap or sanitizer gel
 Distributeur sans contact de savon ou de gel désinfectant
 Touchless-Spender für Seife oder Desinfektionsgel
 Dosificador de jabón o gel desinfectante sin contacto
 Бесконтактный диспенсер для мыла или геля-антисептика

Acciaio inox AISI 304 e resine termoplastiche

Chromed AISI 304 stainless steel
 and thermoplastic resins
 Acier inoxydable AISI 304
 et résine thermoplastique
 Verchromtem Edelstahl AISI 304
 und Kunststoff
 Acero inox AISI 304
 y resinas termoplásticas
 нержавеющей сталь AISI 304
 и термопластические смолы

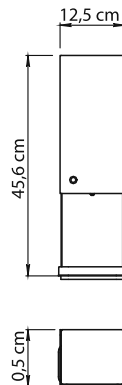

Batterie non include
Batteries not included

Alimentatore 6V-DC non incluso
6V-DC power supply (not included)

14
Nero matt
Matt black

38
Spazzolato
Brushed



Touchless



Struttura
antivandalo
Vandal-Pro
of structure

Idoneo per
gel igienizzante
Suitable for
sanitizer gel

CONTRACT.

Seal.

GEDY

Acciaio inox AISI 304, ottone, Cromall® e resine termoplastiche

Stainless steel AISI 304, brass, Cromall® and thermoplastic resins
Acier inoxydable AISI 304, laiton, Cromall® et résine thermoplastique
Edelstahl AISI 304, Messing, Cromall® und Kunststoff
Acero inox AISI 304, latón, Cromall® y resinas termoplásticas
Нержавеющей стали AISI 304, латунь, Cromall®
и термопластичных



13
Cromato
Chromed



14
Nero matt
Matt black



2074



2079



2087 Kubix.

GEDY

Acciaio inox e resine termoplastiche

Stainless steel and thermoplastic resins
 Acier inoxydable et thermoplastique
 Edelstahl und Kunststoff
 Acero inox y resinas termoplásticas
 Нержавеющей стали
 и термопластичных смол

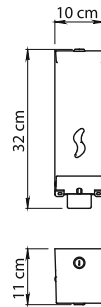

Safety lock



13
Lucido
 Polished

Epos.

GEDY

Acciaio inox AISI 304

Stainless steel AISI 304
 Acier inoxydable AISI 304
 Edelstahl AISI 304
 Acero inoxidable AISI 304
 Изготовлено из AISI 304



2080

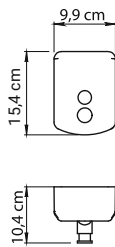

2083

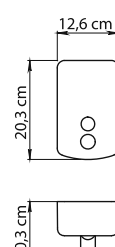

21
Lucido/Spazzolato
 Polished/Brushed

NEW

2084.

GEDY

Distributore di sapone da incasso per top lavabo con erogatore in metallo cromato

Built-in soap dispenser for washbasin top with chromed metal dispenser pump - Distributeur de savon à encastrer pour dessus de lavabo avec pompe en métal chromé - Einbau-Seifenspender für Waschbecken-Top mit Spender aus verchromtem Metall - Dosificador de jabón empotrado para encimera lavabo con dispensador en metal cromado - Встраиваемый дозатор для умывальника

Ottone e resine termoplastiche

Brass and thermoplastic resins - Laiton et résine thermoplastique
 Messing und Kunststoff - Latón y resinas termoplásticas - Латунь и термопластичных



2084



13
Cromato
 Chromed

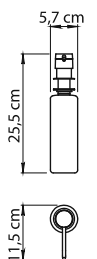

CONTRACT.

2290 Jelly.

GEDY

ABS

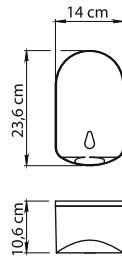

Idoneo per
gel igienizzante

Touchless

02
Bianco
White

Suitable for
satinizer gel

x 4 Batterie non include
6V Batteries not included

2090 Feel.

GEDY

Resine termoplastiche

Thermoplastic resins

Résine thermoplastique

Kunststoff

Resinas termoplásticas

Термопластичные смолы

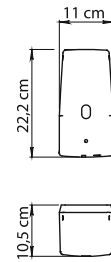

02
Bianco
White



Touchless

x 4 Batterie non include
6V Batteries not included

2291 Push Pro.

100% MADE
in Italy

GEDY

design Makio Hasuike

Resine termoplastiche e ABS

Thermoplastic resins and ABS

Thermoplastique et ABS

Kunststoff und ABS

Résinas termoplásticas y ABS

термопластических смол и ABS

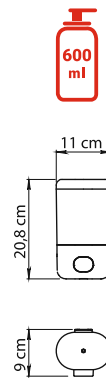

Idoneo per
gel igienizzante

Suitable for
satinizer gel



02
Bianco
White



Con colla
With glue

Con viti
With screws

(Venduta a parte
Sold separately)

Touch.

GEDY

Resine termoplastiche

Thermoplastic resins

Résine thermoplastique

Kunststoff

Resinas termoplásticas

Термопластичные смолы

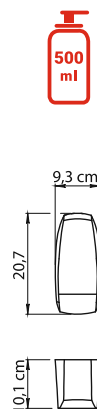

2088

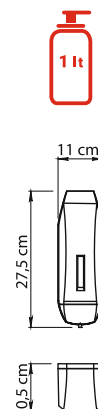

2089



02
Bianco
White

Distributori di sapone e gel igienizzante - Dispensers for soap and sanitizer gel.

2096 Shark.

GEDY

Resine termoplastiche

Thermoplastic resins
Résine thermoplastique
Kunststoff
Resinas termoplásticas
Термопластичные смолы



Eco
Sapone - Soap



Sapone in schiuma
Foam soap

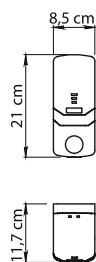

02
Bianco
White



13
Cromato
Chromed



Con biadesivo
With double
sided tape



Con viti
With screws

2097 Cod.

GEDY

Resine termoplastiche

Thermoplastic resins
Résine thermoplastique
Kunststoff
Resinas termoplásticas
Термопластичные смолы

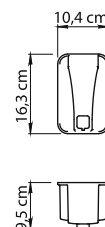

13
Cromato
Chromed



2078 Halibut.

GEDY

Resine termoplastiche

Thermoplastic resins
Résine thermoplastique
Kunststoff
Resinas termoplásticas
Термопластичные смолы

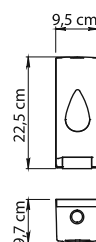

02
Bianco
White



13
Cromato
Chromed



Idoneo per
gel igienizzante
Suitable for
sanitizer gel

2077 Squid.

GEDY

Resine termoplastiche

Thermoplastic resins
Résine thermoplastique
Kunststoff
Resinas termoplásticas
Термопластичные смолы

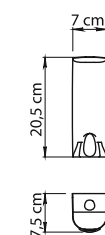

02
Bianco
White



13
Cromato
Chromed



Idoneo per
gel igienizzante
Suitable for
sanitizer gel

CONTRACT.



Mullet.

GEDY

Resine termoplastiche

Thermoplastic resins
Résine thermoplastique
Kunststoff
Resinas termoplásticas
Термопластичные смолы



2294

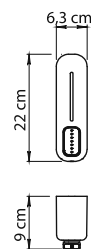

02
Bianco
White



13
Cromato
Chromed



14
Nero matt
Matt black



350
ml



Idoneo per
gel igienizzante

Suitable for
satinizer gel

2092 Snapper.

GEDY

Resine termoplastiche

Thermoplastic resins
 Résine thermoplastique
 Kunststoff
 Resinas termoplásticas
 Термопластичные смолы

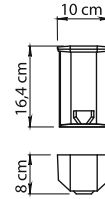

02
 Bianco
 White



Torpedo.

GEDY

Resine termoplastiche

Thermoplastic resins
 Résine thermoplastique
 Kunststoff
 Resinas termoplásticas
 Термопластичные смолы

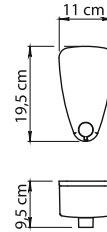

02
 Bianco
 White



2094

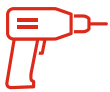

Con viti
 With screws

Con colla
 With glue

(Venduta a parte
 Sold seperately)



Struttura
 antivandalo
 Vandal-Pro
 of structure

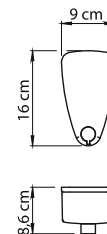

02
 Bianco
 White



13
 Cromato
 Chromed



2093

2091 Marlin.

GEDY

Resine termoplastiche

Thermoplastic resins
 Résine thermoplastique
 Kunststoff
 Resinas termoplásticas
 Термопластичные смолы



02
 Bianco
 White



13
 Cromato
 Chromed



CONTRACT.

2293 Chromis.

GEDY

Acciaio inox e ABS

Stainless steel and ABS
Acier inoxydable et ABS
Edelstahl und ABS
Acero inoxidable y ABS
Нержавеющая сталь и ABS



 x 4 Batterie non incluse
6V Batteries not included

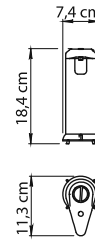

Idoneo per
gel igienizzante
Suitable for
satinizer gel

13
Lucido
Polished



Touchless

2292 Oyster.

GEDY

ABS



 x 4 Batterie non incluse
6V Batteries not included

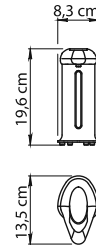

Idoneo per
gel igienizzante
Suitable for
satinizer gel

02
Bianco
White



Touchless

Agave.

GEDY

Resine termoplastiche

Thermoplastic resins
Résine thermoplastique
Kunststoff
Resinas termoplásticas
Термопластичные смолы



2157





S9
Ambra
Amber



Idoneo per
gel igienizzante
Suitable for
satinizer gel

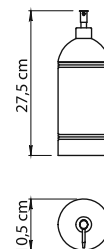

2158



Phon con supporto a parete

Hair dryer with wall support - Sèche cheveux avec support mural
Haartrockner mit Wandhalter - Secador de pelo con soporte y toma
Настенный фен для волос

5054 Grecale Shaver.

GEDY

Con presa rasoio

With electrical socket for shavers
Avec prise pour les rasoirsacier
Mit Steckdose für Rasierapparate
Con toma de corriente para máquina de afeitar
С розеткой для электробритов

Resine termoplastiche e acciaio inox

Thermoplastic resins and stainless steel
Thermoplastique et acier inoxydable
Kunststoff und Edelstahl
Resinas termoplásticas y acero inox
Термопластическая смола и нержавеющая сталь



1300W - IP23 - 220-240 V - 50-60 Hz



43
Nero/Cromato
Black/Chromed

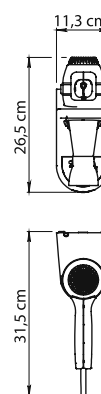

5057 Levante.

GEDY

ABS



Pieghevole
Folding



02
Bianco
White



1650 W - IP20 - 220-240 V - 50-60 Hz

5058 Maestrale.

GEDY

ABS

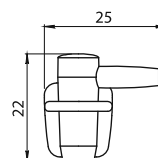

02
Bianco
White



1800W - IP20 - 220-240 V - 50-60 Hz

CONTRACT.

5053 Zefiro.

GEDY

Resine termoplastiche

Thermoplastic resins
Résine thermoplastique
Kunststoff
Resinas termoplásticas
Термопластичные смолы



1200 W - IP20 - 220-240 V - 50-60 Hz

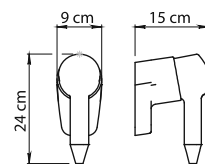

02
Bianco
White

5052 Albatros.

GEDY

design Ambrogio Rossari

Resine termoplastiche

Thermoplastic resins
Résine thermoplastique
Kunststoff
Resinas termoplásticas
Термопластичные смолы

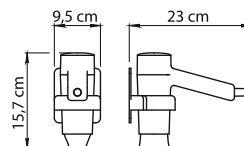

02
Bianco
White



1200 W - IPX0 - 230 V

Asciugamani elettrici

Air hand dryers - Sèche-mains - Händetrockner
Secador de manos - Электрическая сушилка

2451 Burian.

GEDY

Asciugamani antivandalo ad aria calda con pulsante

Vandal-proof hot air hand dryer with pushbutton action
Sèche-mains anti-vandalisme à air chaud avec bouton
Bruchsicherer Heissluft-Händetrockner mit Taste
Secador de aire caliente para las manos resistente
al vandalismo con pulsador
Сушилка для рук с защитой от вандалов,
с горячим воздухом и кнопкой

Acciaio porcellanato

Vitreous enamel steel - Acier émaillé
Emaille - Acero porcelanizado
Сталь, обработанная под фарфор



Struttura
antivandalo
Vandal-Pro
of structure



02
Bianco
White

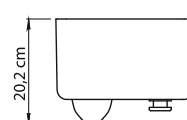
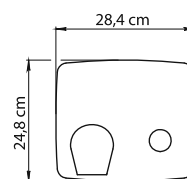

2400 W - IPX1
220-240 V - 50-60 Hz

Asciugamani elettrici - Air hand dryes .

2454 Bora.

GEDY

Asciugamani elettrico a fotocellula Eco-Jet

Eco Jet electric hand dryer with photocell
 Sèche-mains électrique à cellule photoélectrique Eco-Jet
 Elektrischer Händetrockner mit Öko-Jet-Fotozelle
 Secador de manos eléctrico con fotocélula Eco-Jet
 Elektrische handdrogers met Eco-Jet fotocel
 Электрическая сушилка для рук с фотоэлементом



Asciugatura
10/15 sec.
 Drying time
10/15 sec.



Velocità aria
300 Km/h
 Speed air
300 Km/h



Eco - Green
Energy saving



Igiene
integrata
Integrated
hygiene



02
Bianco
White



85
Antracite
satinato
Anthracite
satinized

Polipropilene

Polypropylene - Polypropylène
 Polypropylen - Polipropileno
 Полипропилен

Acciaio inox

Stainless steel - Acier inoxydable
 Edelstahl - Acero inoxidable
 Изготовлено из AISI 304

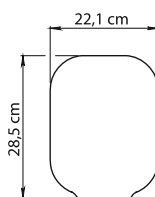

13
Cromato
Chromed



Acciaio inox AISI 304

Stainless steel AISI 304 - Acier inoxydable AISI 304
 Edelstahl AISI 304 - Acero inoxidable AISI 304
 Изготовлено из AISI 304

1100 W - IP23
 220-240 V - 50-60 Hz



2455 Alizé.

GEDY

Asciugamani elettrico a fotocellula Eco-Jet

Eco Jet electric hand dryer with photocell
 Sèche-mains électrique à cellule photoélectrique Eco-Jet
 Elektrischer Händetrockner mit Öko-Jet-Fotozelle
 Secador de manos eléctrico con fotocélula Eco-Jet
 Elektrische handdrogers met Eco-Jet fotocel
 Электрическая сушилка для рук с фотоэлементом



Asciugatura
10/15 sec.
 Drying time
10/15 sec.



Velocità aria
200 Km/h
 Speed air
200 Km/h



Eco - Green
Energy saving



02
Bianco
White



13
Cromato
Chromed



21
Satinato
Satinized



14
Nero
Black

ABS

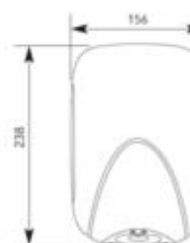

900 W - IP23 - 220-240 V - 50-60 Hz

C O N T R A C T .

2456 Brisa.

GEDY

Asciugamani con motore ad induzione con fotocellula

Towel with induction motor and photocell
Sèche-mains à moteur à induction à cellule
photoélectrique

Händetrockner mit Induktionsmotor
und Fotozelle

Secador de manos con motor
de inducción con fotocélula

Сушилка для рук с индукционным
двигателем и фотоэлементом

ABS



1850 W - IPX2 - 220-240 V - 50-60 Hz

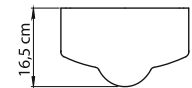
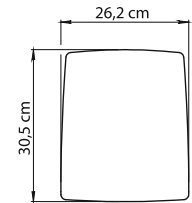
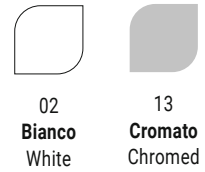

2453 Diablo.

GEDY

Asciugamani elettrico a fotocellula Eco-Jet ad inserimento verticale delle mani

Photocell electronic hand-dryer
with photocell for vertical insertion of hands
Sèche-mains électrique à cellule photoélectrique Eco-
Jet à introduction
des mains verticale

Elektrischer Händetrockner mit Öko-Jet-Fotozelle
und vertikaler Handeinführung - Secador de manos
eléctrico con fotocélula

Eco-Jet con introducción vertical de las manos
Электрическая сушилка для рук с фотоэлементом
Eco-Jet, вертикальная

ABS

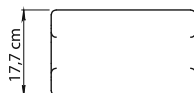
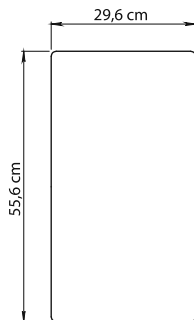

1450 W - IP34 - 220-240 V - 50-60 Hz

582



Asciugatura
10/15 sec.
Drying time
10/15 sec.



Velocità aria
410 Km/h
Speed air
410 Km/h



Eco - Green
Energy saving



Igiene
integrata
Integrated
hygiene

Distributori di carta

Paper towel dispensers - Distributeur de serviettes

Papierspender - Dispensador de toallas

Ёмкость для бумаги

2436.

GEDY

Distributore salviette carta
(max 26,5x9,5x32 cm)

max 400 fogli

Tissue dispenser - max 400 tissues

Distributeur serviettes - max 400 serviettes

Tuchspender - max 400 Tücher

Dispensador de toallas - max 400 toallas

Ёмкость для бумажных салфеток.

максимальные 400 тканей

Acciaio inox AISI 304

Stainless steel AISI 304

Acier inoxydable AISI 304

Edelstahl AISI 304

Нержавеющая сталь AISI 304



15
YEARS

GARANZIA
WARRANTY



13
Lucido
Polished



38
Spazzolato
Brushed

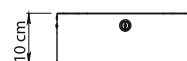
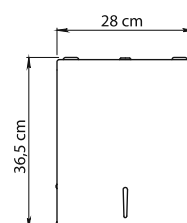

NEW

100%
AISI
304

2251
2251/01

Compatibile
Compatible



Serratura
di sicurezza
Safety lock

2427.

GEDY

100% MADE
in Italy



Distributore salviette carta
(max 25x10x37 cm)

max 450 fogli

Tissue dispenser - max 450 tissues

Distributeur serviettes - max 450 serviettes

Tuchspender - max 450 Tücher

Dispensador de toallas - max 400 toallas

Ёмкость для бумажных салфеток.

максимальные 450 тканей

Resine termoplastiche

Thermoplastic resins

Thermoplastique

Kunststoff

Resinas termoplásticas

термопластичные смолы



15
YEARS

GARANZIA
WARRANTY



02
Bianco
White

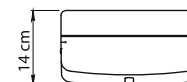
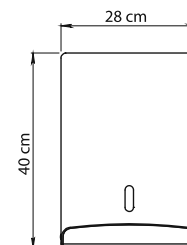

2251
2251/01

Compatibile
Compatible



Serratura
di sicurezza
Safety lock

C O N T R A C T .

2426.

GEDY

100% MADE
in Italy



**Distributore salviette di carta piegate
(max 24,5x10x24 cm - max 300 fogli)
o a rotolo (max ø 14x24,5 cm)**

Dispenser for papersheets
max 300 tissues - or paper-rolls
Distributeur papier en feuilles
max 400 serviettes - ou en rouleau
Papierspender für Einzelblätter
max 400 Tücher - oder Rollen
Dispensador de toallitas
max 400 toalla - o de papel en rollo
Ёмкость для салфеток
максимальные 400 тканей - или рулона

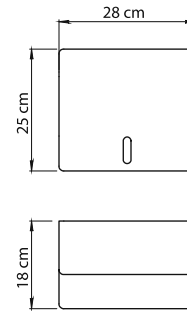

02
Bianco
White

2251
2251/01
2254

Compatibile

Compatibile

2437.

GEDY

100% MADE
in Italy



**Distributore di carta asciugamani a spirale
(max ø 16 x h. max 23 cm)**

Spiral paper hand towel dispenser
Distributeur de papier essuie-mains en spirale
Handtuchrollen-Spender
Dispensador de toallitas para secar las manos en espiral
Спиральный диспенсер бумаги для рук

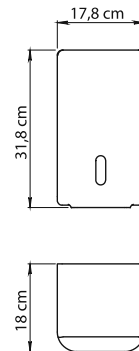

02
Bianco
White

2254

Compatibile

Compatibile

2442.

GEDY

**Distributore salviette carta - max 300 fogli
(max 24,5 x 8,5 x 24 cm)**

Tissue dispenser - max 300 tissues
Distributeur serviettes - max 300 serviettes
Tuchspender - max 300 Tücher
Dispensador de toallas - max 300 toallas
Ёмкость для бумажных салфеток.
максимальные 300 тканей

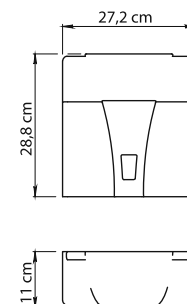

11
Azzurro
Light blue



02
Bianco
White

2251
2251/01

Compatibile

Compatibile

2440.

GEDY

**Distributore salviette carta
(max 23,8x8x26 cm) max 200 fogli**

Tissue dispenser - max 200 tissues
Distributeur serviettes - max 200 serviettes
Tuchspender - max 200 Tücher
Dispensador de toallas - max 200 toallas
Ёмкость для бумажных салфеток.
максимальные 200 тканей

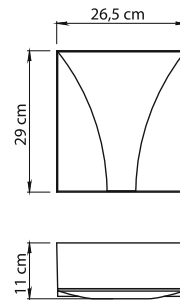

11
Azzurro
Light blue

Resine termoplastiche

Thermoplastic resins
Thermoplastique
Kunststoff
Resinas termoplásticas
термопластичные смолы

2251
2251/01

Compatibile
Compatible

2424.

GEDY

**Distributore per rotoli di carta igienica
(max ø 30 cm)**

Rollpaper dispenser
Distributeur papier à rouleau
Rollenpapierspender
Dispensador rollos de papel
Ёмкость для туалетной бумаги

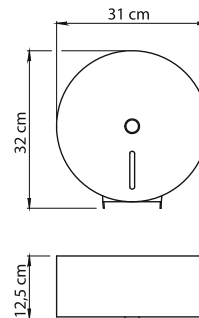

13
Lucido
Polished

100%
AISI
304

2252
2253

Compatibile
Compatible



Serratura
di sicurezza
Safety lock

15
YEARS

GARANZIA
WARRANTY

Acciaio inox AISI 304

AISI 304 stainless steel - acier inoxydable AISI 304
Edelstahl AISI 304 - acero inox AISI 304
нержавеющая сталь AISI 304

2446.

GEDY

**Distributore per rotoli di carta igienica
(max ø 26 cm)**

Rollpaper dispenser
Distributeur papier à rouleau
Rollenpapierspender
Dispensador rollos de papel
Ёмкость для туалетной бумаги

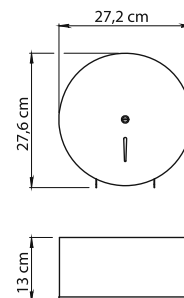

13
Lucido
Polished



38
Spazzolato
Brushed

NEW

100%
AISI
304

2252
2253

Compatibile
Compatible



Serratura
di sicurezza
Safety lock

15
YEARS

GARANZIA
WARRANTY

Acciaio inox AISI 304

AISI 304 stainless steel - acier inoxydable AISI 304
Edelstahl AISI 304 - acero inox AISI 304
нержавеющая сталь AISI 304

C O N T R A C T .

2429 Jumbo Maxi.

100% MADE
in Italy

GEDY

Distributore per rotoli di carta igienica
(max ø 34 x 12 cm)

Rollpaper dispenser

Distributeur papier à rouleau

Rollenpapierspender - Dispensador rollos de papel

Ёмкость для туалетной бумаги

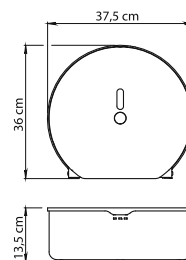

02
Bianco
White

2252
2253

Compatibile
Compatible

2428 Jumbo Mini.

100% MADE
in Italy

GEDY

Distributore per rotoli di carta igienica
(max ø 24,5 cm)

Rollpaper dispenser

Distributeur papier à rouleau

Rollenpapierspender - Dispensador rollos de papel

Ёмкость для туалетной бумаги

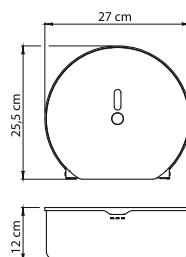

02
Bianco
White

2252

Compatibile
Compatible

2443.

GEDY

Distributore per rotoli di carta igienica
(max ø 21,5 x 1 cm)

Rollpaper dispenser

Distributeur papier à rouleau

Rollenpapierspender - Dispensador rollos de papel

Ёмкость для туалетной бумаги

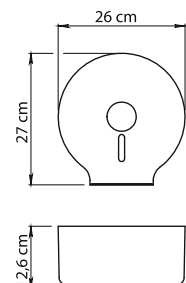

02
Bianco
White



11
Azzurro
Light blue



Serratura
di sicurezza
Safety lock

2252

Compatibile
Compatible

2441.

GEDY

Distributore per rotoli di carta igienica
(max ø 19 x 10 cm)

Rollpaper dispenser

Distributeur papier à rouleau

Rollenpapierspender - Dispensador rollos de papel

Ёмкость для туалетной бумаги

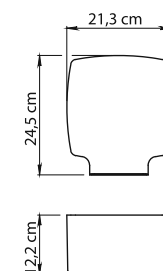

85
Antracite
Anthracite

2252

Compatibile
Compatible

A624 Maldive.

TOP DESIGN

Portarotolo

Toilet paper holder
Porte rouleau
Papierrollenhalter
Portarrollos
Бумагодержатель

Ottone e Cromall®

brass and Cromall®
laiton et Cromall®
Messing und Cromall®
latón y Cromall®
Нержавеющая латунь и Cromall®

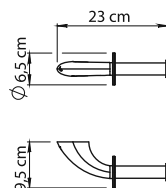

13
Cromato
Chromed

15
YEARS
GARANZIA
WARRANTY

2839.

RETAIL

Portarotolo singolo coperto con piano d'appoggio

Single covered roll holder with support surface
Porte-rouleau papier toilette avec couvercle
et support de rangement
Einzelrollenhalter mit Abdeckung und Auflagefläche
Portarrollos individual cubierto con superficie de apoyo
Одинарный держатель туалетной бумаги
закрытого типа с опорной поверхностью

Acciaio inox AISI 304 e Cromall®

Stainless steel AISI 304 and Cromall®
Acier inoxydable AISI 304 et Cromall®
Edelstahl AISI 304 und Cromall®
Acero inox AISI 304 y Cromall®
Нержавеющая сталь AISI 304 и Cromall®

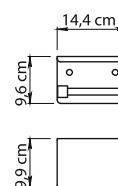

13
Cromato
Chromed

14
Nero matt
Matt black

15
YEARS
GARANZIA
WARRANTY

2339.

GEDY

Portarotolo doppio coperto con piano d'appoggio

Double toilet paper holder with support stand
Porte rouleau papier WC couvert
Doppelte Rollenhalterung, abgedeckt durch Auflagefläche
Portarrollos doble cubierto con superficie de apoyo
Стойка с двойным закрытым держателем рулона

Acciaio inox AISI 304

Stainless steel AISI 304
Acier inoxydable AISI 304
Edelstahl AISI 304
Acero inox AISI 304
Нержавеющая сталь AISI 304

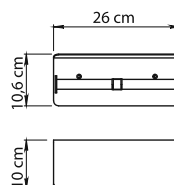

13
Lucido
Polished

15
YEARS
GARANZIA
WARRANTY

2039.

GEDY

Portarotolo singolo coperto con piano d'appoggio

Single covered roll holder with support surface
 Porte-rouleau papier toilette avec couvercle
 et support de rangement
 Einzelrollenhalter mit Abdeckung und Auflagefläche
 Portarrollos individual cubierto con superficie de apoyo
 Одинарный держатель туалетной бумаги
 закрытого типа с опорной поверхностью

Acciaio inox e Cromall®

Stainless steel and Cromall®
 Acier inoxydable et Cromall®
 Edelstahl und Cromall®
 Acero inox y Cromall®
 Нержавеющая сталь и Cromall®



02
Bianco
White



13
Cromato
Chromed



14
Nero matt
Matt black

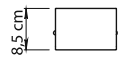
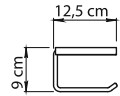

GARANZIA
WARRANTY

2225 Sparrow.

GEDY

Portarotolo coperto

Paper holder with cover
 Porte rouleau avec couvercle
 Papierrollenhalter mit Deckel
 Portarrollo con tapa
 Бумагодержатель с крышкой

Acciaio inox e Cromall®

Stainless steel and Cromall®
 Acier inoxydable et Cromall®
 Edelstahl und Cromall®
 Acero inox y Cromall®
 Нержавеющая сталь и Cromall®



Con colla
With glue

Venduta a parte
Sold separately



Con viti
With screws



Gira la placca
come vuoi
Turn the plate



13
Cromato
Chromed

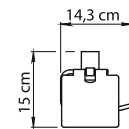

GARANZIA
WARRANTY

2308.

GEDY

Porta fazzoletti (max 24,5 x 12,5 cm)

Tissue box - Boîte à mouchoirs - Tücherbehälter
 Porta pañuelos - Ёмкость для салфеток

Acciaio inox AISI 304

Stainless steel AISI 304
 Acier inoxidable AISI 304
 Edelstahl AISI 304
 Acero inox AISI 304
 Нержавеющая сталь AISI 304



13
Lucido
Polished



38
Spazzolato
Brushed



2251
2251/01
Compatibile
Compatible

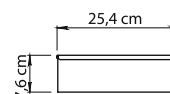

GARANZIA
WARRANTY

Distributori di carta - Paper dispensers.

2002.

GEDY

Porta fazzoletti

Tissue box - Boîte à mouchoirs - Tücherbehälter
Porta pañuelos - Ёмкость для салфеток

Acciaio inox AISI 304

Stainless steel AISI 304 - Acier inoxydable AISI 304
Edelstahl AISI 304 - Acero inox AISI 304
Нержавеющая сталь AISI 304

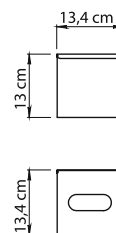

13
Lucido
Polished



GARANZIA
WARRANTY

2008.

GEDY

100% MADE
in **Italy**



design Makio Hasuike

Porta fazzoletti

Tissue box - Boîte à mouchoirs
Tücherbehälter - Porta pañuelos
Ёмкость для салфеток

Resine termoplastiche

Thermoplastic resins - Résine thermoplastique
Kunststoff - Resinas termoplásticas
Термопластичные смолы

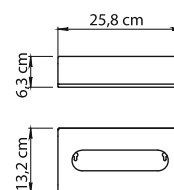

02
Bianco
White



13
Cromato
Chromed



Con viti
With screws

2330.

GEDY

Porta sacchetti igienici

Holder for sanitary towel bags
Porte-sachets hygiéniques
Behälter für Hygienebeutel
Porta-bolsitas higiénicas
Урна для гигиенических прокладок

Acciaio inox AISI 304

Stainless steel AISI 304 - Acier inoxydable AISI 304
Edelstahl AISI 304 - Acero inox AISI 304
Нержавеющая сталь AISI 304

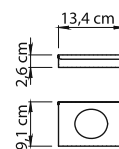

13
Lucido
Polished



38
Spazzolato
Brushed



GARANZIA
WARRANTY

2430.

GEDY

100% MADE
in **Italy**



Porta sacchetti igienici

Holder for sanitary towel bags
Porte-sachets hygiéniques
Behälter für Hygienebeutel
Porta-bolsitas higiénicas
Урна для гигиенических прокладок

Resine termoplastiche

Thermoplastic resins - Résine thermoplastique
Kunststoff - Resinas termoplásticas - Термопластичные смолы

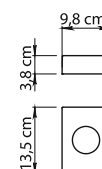

02
Bianco
White



13
Cromato
Chromed



Con viti
With screws



Con biadesivo
With double
sided tape

CONTRACT.

Materiale di consumo

Refills - Pièces de recharge - Nachfüllungsteile
Piezas de recarga - Заполнение

Aloe.

GEDY

100% MADE
in Italy

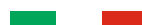

Prodotto riciclato
Recycled product

2251.



21 x 11 x 8 cm - 21 x 8 (1pz/pcs)

conf. da 150 pz.

box of 150 pcs - confection de 150 pièces - Box von 150 St.
confección de 150 piezas - коробка 150 уастей

2251-01.



21 x 11 x 16 cm - 21 x 8 (1pz/pcs)

conf. da 300 pz.

box of 300 pcs - confection de 300 pièces - Box von 300 St.
confección de 300 piezas - коробка 300 уастей

Salviette in carta ecologica riciclata piegate a Z

Serviettes écologiques en papier recyclé plié en Z - Servietten mit Z-Falz aus umweltfreundlichem Recyclingpapier
Toallitas de papel ecológico reciclado intercaladas - Ανακυκλωμένα οικολογικά μαντηλάκια τυλιγμένα σε Z

2252.



ø 19 x 18 cm - ø 19 x 9 (1 pz/pcs) - mt 150 cad./each

conf. da 150 pz.

box of 150 pcs - confection de 150 pièces - Box von 150 St.
confección de 150 piezas - коробка 150 уастей

2253.



ø 26,5 x 18 cm - ø 26,5 x 9 (1 pz/pcs) - mt 300 cad./each

conf. da 300 pz.

box of 300 pcs - confection de 300 pièces - Box von 300 St.
confección de 300 piezas - коробка 300 уастей

Carta igienica in carta ecologica riciclata - confezione da 2 rotoli

Papier toilette écologique recyclé - Colis de 2 rouleaux - Toilettenpapier aus umweltfreundlichem Recyclingpapier Packung mit 2 Rollen - Papel higiénico de papel ecológico reciclado - paquete de 2 rollos - Туалетная бумага из рециклированной экологичной бумаги - в упаковке 2 рулона

2254.

Carta asciugamani a spirale in carta ecologica riciclata - confezione da 2 rotoli

Essuie-mains en papier écologique recyclé à dévidage en spirale - Colis de 2 bobines
Handtuchrollen mit Innenabzug aus umweltfreundlichem Recyclingpapier
Packung mit 2 Rollen - Toalla de papel en rollo de papel ecológico reciclado - paquete de 2 rollos - Полотенца спиральной навивки из рециклированной экологичной бумаги - в упаковке 2 рулона



26 x 12,5 x 19 cm - ø 12,5 x 19 (1 pz/pcs)
mt 68 cad./each

Filo stendibiancheria riavvolgibile

Retractable clothes line - Sèche linge retractable
 Aufrollbarer Wäschetrockner - Tendedero enrollable ocultador
 Выдвижная нить для сушки белья

2450 Tullo.

GEDY

Acciaio inox

Stainless steel
 Acier inoxydable
 Edelstahl
 Acero inox
 Нержавеющая сталь

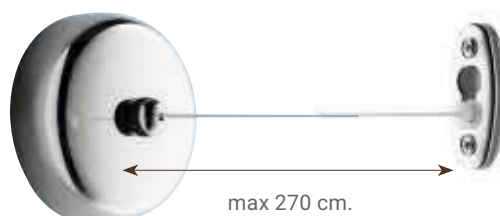

max 270 cm.

ø 9,3 x H5,5 cm



13
Lucido
 Polished



Estensibile
 Extensible

Mensole porta asciugamani

Shelves for towels - Etagères porte serviette - Handtuchablage
 Estantes para toallas - Держатель полотенца

3235 Outline.

TOP DESIGN

design Simone Micheli

Acciaio inox, ottone e Cromall®

Stainless steel, brass and Cromall®
 Acier inoxydable, laiton et Cromall®
 Edelstahl, Messing und Cromall®
 Acero inox, latón y Cromall®
 Нержавеющая сталь,
 латунь и Cromall®

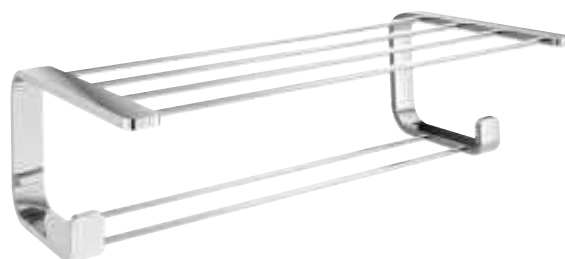

15
 YEARS

GARANZIA
 WARRANTY

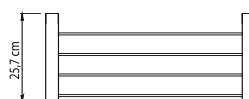
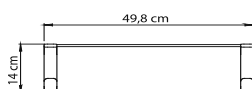

13
Cromato
 Chromed



14
Nero matt
 Matt black



22
Bianco matt
 Matt white

A235 Canarie.

TOP DESIGN

Ottone e Cromall®

Brass and Cromall®
 Laiton et Cromall®
 Messing und Cromall®
 Latón y Cromall®
 Латунь и Cromall®



15
 YEARS

GARANZIA
 WARRANTY

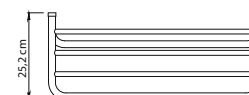
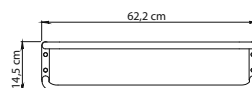

13
Cromato
 Chromed

CONTRACT.

Febo.

RETAIL

Acciaio inox e Cromall®

Stainless steel and Cromall®
Acier inoxidable et Cromall®
Edelstahl und Cromall®
Acero inox y Cromall®
Нержавеющая сталь
и Cromall®

10
YEARS

GARANZIA
WARRANTY



13
Cromato
Chromed

5335

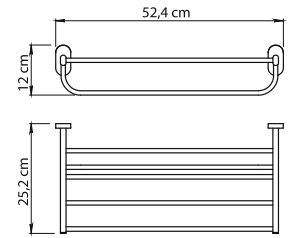

5344

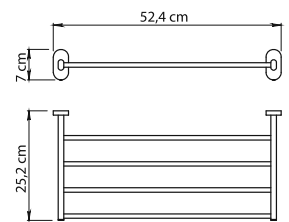

Project.

GEDY

Acciaio inox AISI 304

Stainless steel AISI 304
Acier inoxidable AISI 304
Edelstahl AISI 304
Acero inox AISI 304
Нержавеющая сталь AISI 304

100%
AISI
304

15
YEARS

GARANZIA
WARRANTY



13
Lucido
Polished

5035

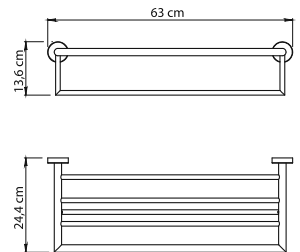

5044

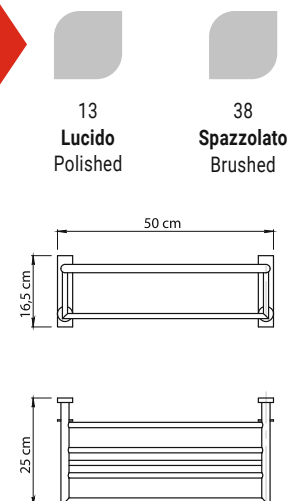

Ascot.

GEDY

design Carlo Vietri

Acciaio inox e Cromall®
 Stainless steel and Cromall®
 Acier inoxydable et Cromall®
 Edelstahl und Cromall®
 Acero inox y Cromall®
 Нержавеющая сталь
 и Cromall®

2435

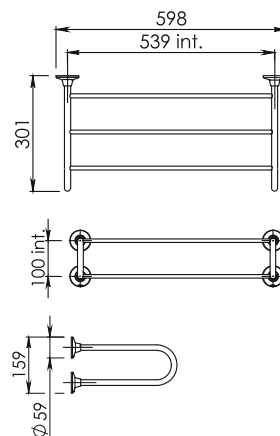
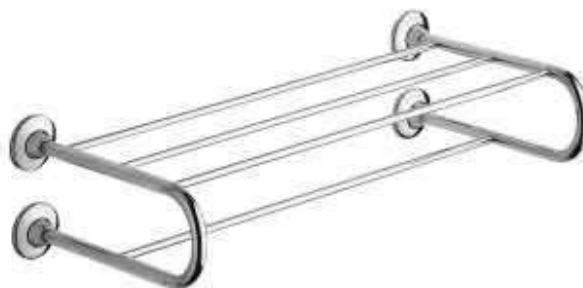

13
Cromato
 Chromed

2735

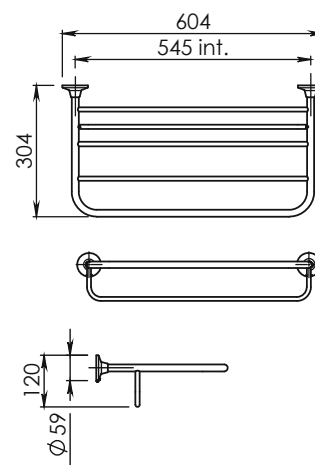
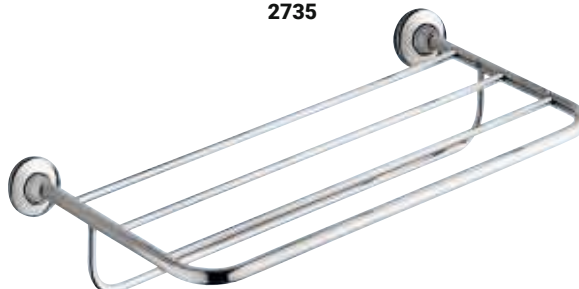

2744

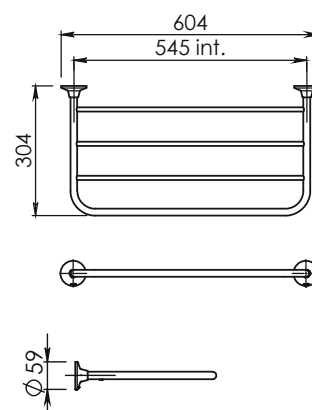

Edera.

GEDY

Acciaio inox e Cromall®
 Stainless steel and Cromall®
 Acier inoxydable et Cromall®
 Edelstahl und Cromall®
 Acero inox y Cromall®
 Нержавеющая сталь
 и Cromall®

ED35

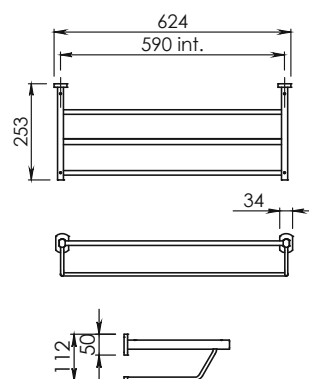

ED44

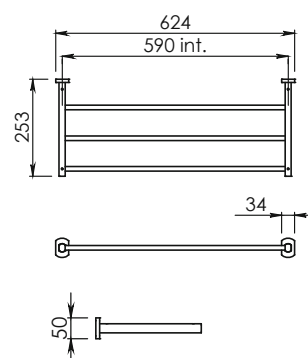

13
Cromato
 Chromed

Felce.

GEDY

Acciaio e Cromall®
 Steel and Cromall®
 Acier et Cromall®
 Stahl und Cromall®
 Acero y Cromall®
 Сталь и Cromall®

FE35

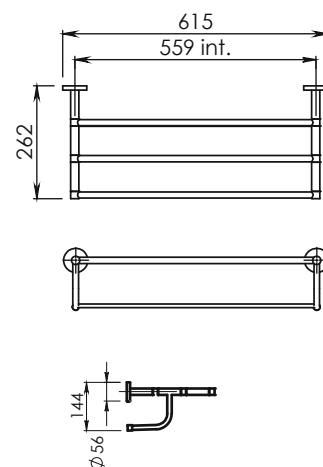

FE44

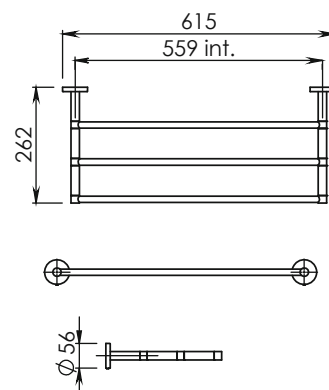

13
Cromato
 Chromed

Mensole porta asciugamani - Shelves for towels.

Maniglioni

Grab bar - Barre d'appui - Wannengriff- Asideros - Поручень



A621-50 Maldive.

TOP DESIGN

Cromall® e ottone

Cromall® and brass

Cromall® et laiton

Cromall® und Messing

Cromall® y latón

Cromall® и латунные



13
Cromato
Chromed



15
YEARS

GARANZIA
WARRANTY

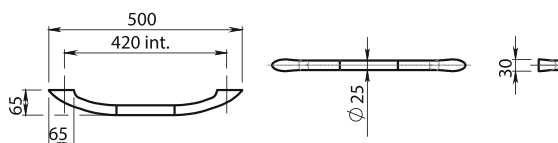

CONTRACT.

Canarie.

TOP DESIGN

Cromall® e ottone

Cromall® and brass
 Cromall® et laiton
 Cromall® und Messing
 Cromall® y latón
 Cromall® и латунные



A221-28

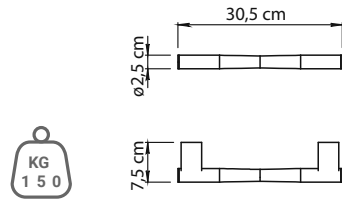

13
Cromato
 Chromed



GARANZIA
 WARRANTY



A222

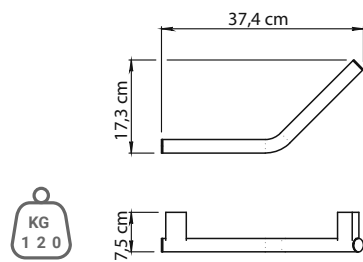

Outline.

TOP DESIGN

design Simone Micheli

Cromall® e ottone

Cromall® and brass
 Cromall® et laiton
 Cromall® und Messing
 Cromall® y latón
 Cromall® и латунные



3221-25

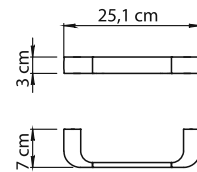
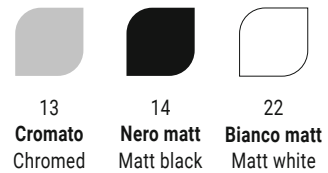

3221-35

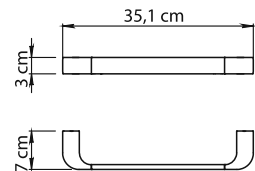

GARANZIA
 WARRANTY



3221-55

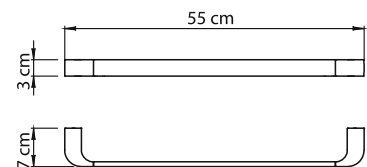

Project.

GEDY



GARANZIA
WARRANTY



13
Lucido
Polished

38
Spazzolato
Brushed

Acciaio inox AISI 304

304 AISI stainless steel

Acier inox AISI 304

Edelstahl AISI 304

Acero inox AISI 304

Сталь AISI 304

CONFORME
IN CONFORMITY WITH
UNI11064:2003



Reversibile
Reversible

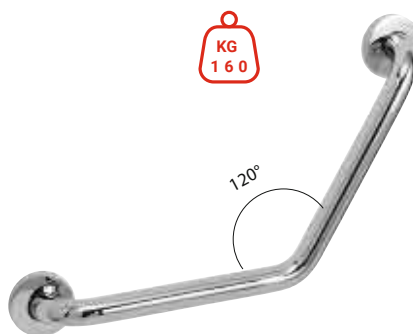

5022

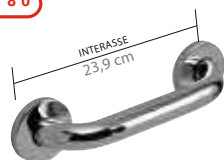
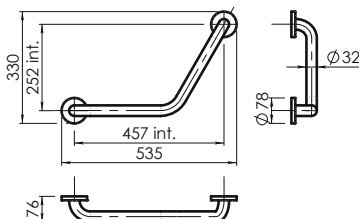

5021-24

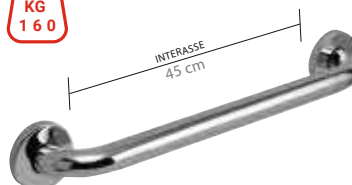
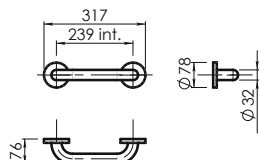

5020-45

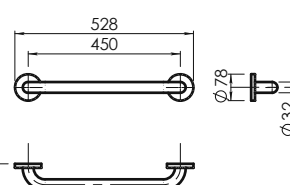

Ascot.

GEDY



Reversibile
Reversible



GARANZIA
WARRANTY

design Carlo Vietri

Acciaio inox AISI 304, alluminio e Cromall®

Stainless steel AISI 304, aluminum and Cromall®

Acier inoxydable AISI 304, aluminium et Cromall®

Edelstahl AISI 304, Aluminium und Cromall®

Acero inox AISI 304, aluminio y Cromall®

Нержавеющая сталь AISI 304, алюминия и Cromall®

13
Cromato
Chromed



2720

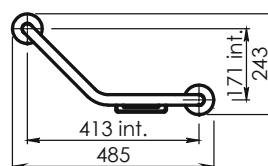
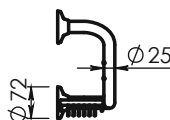

2722

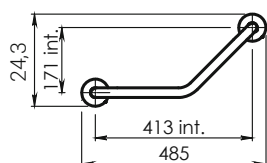

con portasapone in filo reversibile in acciaio inox
with reversible wire soap holder in stainless steel
avec porte savon fil réversible en acier inoxydable
mit umkehrbarer Stabseifenschale aus Edelstahl
con jabonera de varillas movil en acero inox
с мыльницей с проволочным основанием ие нержавеющей стали

Edera.

GEDY

Acciaio inox AISI 304 e Cromall®

Stainless steel AISI 304 and Cromall®
 Acier inoxydable AISI 304 et Cromall®
 Edelstahl AISI 304 und Cromall®
 Acero inox AISI 304 y Cromall®
 Нержавеющая сталь AISI 304 и Cromall®



GARANZIA
WARRANTY



13
Cromato
Chromed

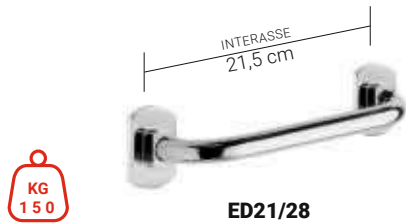

ED21/28

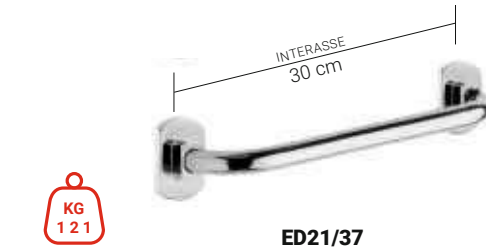
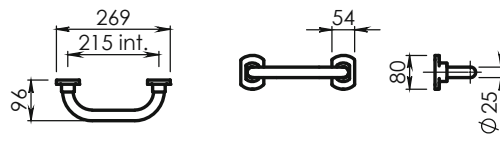

ED21/37

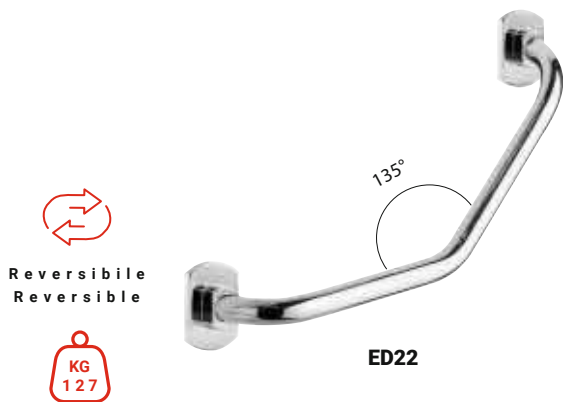
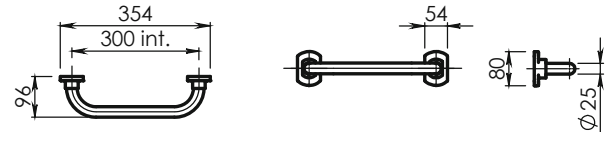

ED22

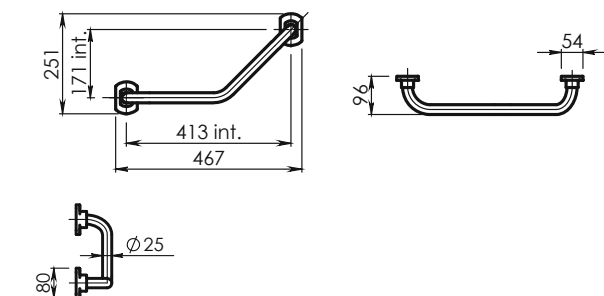

ED20

Acciaio inox AISI 304, alluminio e Cromall®

Stainless steel AISI 304, aluminum and Cromall®
 Acier inoxydable AISI 304, aluminium et Cromall®
 Edelstahl AISI 304, Aluminium und Cromall®
 Acero inox AISI 304, aluminio y Cromall®
 Нержавеющая сталь AISI 304, алюминия и Cromall®

con portasapone in filo reversibile in acciaio inox

with reversible wire soap holder in stainless steel
 avec porte savon fil réversible en acier inoxydable
 mit umkehrbarer Stabseifenschale aus Edelstahl
 con jabonera de varillas móvil en acero inox
 с мыльницей с проволочным основанием ие нержавеющей стали

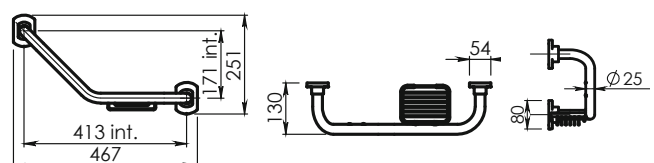

Maniglioni - Grab bars.

Up.

CONFORME - IN CONFORMITY WITH UNI11064:2003

GEDY

Acciaio inox

Stainless steel - Acier inox - Edelmetall - Acero inox - Сталь

10 YEARS

GARANZIA WARRANTY



02 Bianco White



14 Nero matt Matt black



13 Cromato Chromed

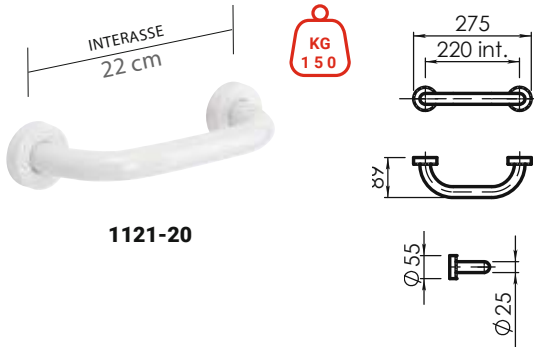

1121-20



1121-30



1121-45



1122



Reversible Reversible

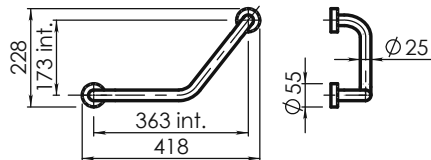
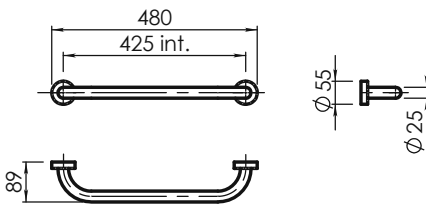

5657 Snug.

NEW

GEDY

Acciaio inox AISI 304

304 AISI stainless steel - Acier inox AISI 304

Edelmetall AISI 304 - Acero inox AISI 304 - Сталь AISI 304

100% AISI 304

10 YEARS

GARANZIA WARRANTY



13 Cromato Chromed



14 Nero matt Matt black



38 Spazzolato Brushed

Meccanismo di ribaltamento in posizione orizzontale e verticale
 Collapsible mechanism in horizontal and vertical position
 Mécanisme de basculement en position horizontale et verticale
 Kippmechanismus in waagerechter und in senkrechter Position
 Mecanismo de abatimiento en posición horizontal y vertical
 Откидной механизм в вертикальном и горизонтальном положении



KG 150

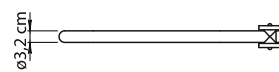
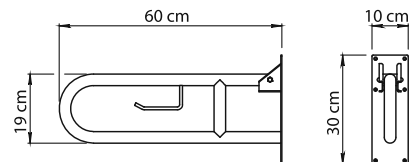

CONTRACT.

GEDY

Project.

Realizzata in acciaio inox AISI 304 con contenitori in vetro satinato

Made of AISI 304 stainless steel with frosted glass containers

Réalisée en acier inoxydable AISI 304 avec boîtiers en verre satiné

Hergestellt aus Edelstahl AISI 304 mit Behältern aus satiniertem Glas

Realizada en acero inox AISI 304 con contenedores en cristal satinado

Изготовлено из нержавеющей стали AISI 304 с ёмкостями из матового стекла

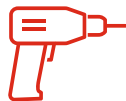

Con viti

With screws



GARANZIA

WARRANTY



13

Lucido
Polished



38

Spazzolato
Brushed

CONTRACT

GEDY



CONFORME / IN CONFORMITY WITH UNI11064:2003

K G 180

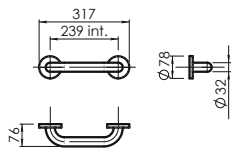

5020-24

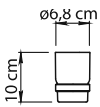

5010

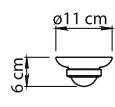

5011

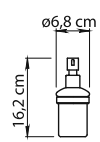

5081

K G 160

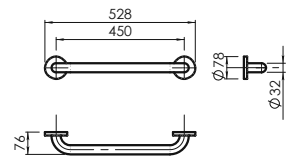

5020-45

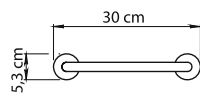

5021-30

K G 160



Reversible
Reversible

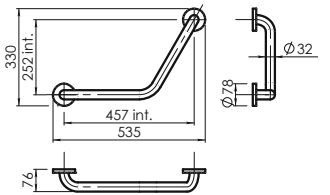

5022

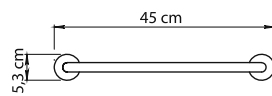

5021-45

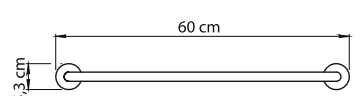

5021-60

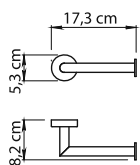

5024

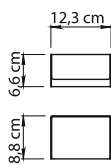

5025

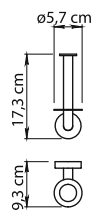

5024-02

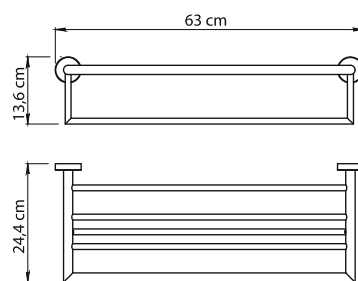

5044

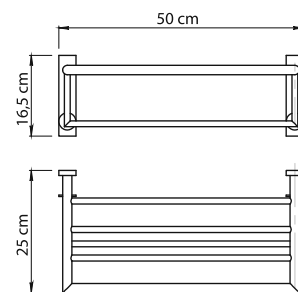

5035

NEW 13 38

13
solo - only

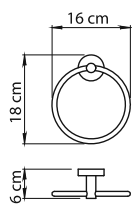

5070

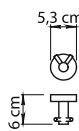

5026



5027

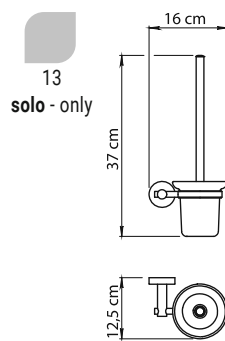

5033-03

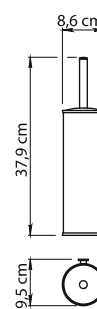

5034-03



5034

PRIMA CLASSE

Programma in acciaio inox e nylon

Program made of stainless steel and nylon

Programme en acier inoxydable et nylon

Programm aus Edelstahl und Nylon - Programa en acero inox y nylon

Программа из нержавеющей стали и нилон



13

Cromato
Chromed

Ø 32 mm

100% MADE
in Italy

Massima funzionalità, materiali di alta qualità e un sistema modulare: questo il programma PRIMA CLASSE. Il sistema di maniglioni è realizzato in acciaio inox in finitura lucida e completato con il maniglione di sostegno e l'appoggio ribaltabile, con o senza portarotolo, dalla forma moderna e chic.

Absolute functionality, high-quality materials and modular construction system: those are the outstanding characteristics of the PRIMA CLASSE program of safety grab bars. The handles are made of stainless steel in polished finishing and rounded off by the folding and support handle, with or without paper holder, in a modern and elegant design.

Absolute Funktionalität, hochwertige Materialien und modulares Baukastensystem: diese sind die herausragenden Merkmale des Sitz- und Griffsystems PRIMA CLASSE. Das Griffsystem besteht aus poliertem Edelstahl und abgerundet wird dieses Programm durch den Klapp- und Stützgriff, mit oder ohne Papierrollenhalter, mit einer modernen eleganten Form.

Materiales de alta calidad, funcionalidad absoluta y modularidad: este el programa de asientos y de asideros de seguridad PRIMA CLASSE. El programa de asideros es realizado en acero inoxidable en acabado brillo y es completado por el asidero móvil, con o sin portarrollo y el asidero de apoyo, de forma moderna y elegante.

Une extrême fonctionnalité, des matériaux de haute qualité et un système modulaire: c'est la collection PRIMA CLASSE. Le système de barres est réalisé en acier inoxydable avec finition polie et complété par la barre d'appui et par la barre à abattant, avec ou sans porte papier, de forme moderne et chic.

Максимальная функциональность, высококачественные материалы и модульная система - все это программа "ПЕРВЫЙ КЛАСС". Система ручек изготовлена из нержавеющей стали с блестящей отделкой, дополнена поручнем и откидной ручкой с держателем для туалетной бумаги или без него в современном и шикарном стиле.



6008.

Specchio basculante infrangibile in acciaio inox AISI 304

Shatterproof tilting mirror
in AISI 304 stainless steel
Miroir basculant infrangible
en acier inox AISI 304
Neigbarer bruchsicherer Spiegel
aus Edelstahl AISI 304
Espejo basculante irrompible
de acero inoxidable AISI 304
Поворотное зеркало небьющееся
из нержавеющей стали AISI 304



GARANZIA
WARRANTY



13
Super
Mirror

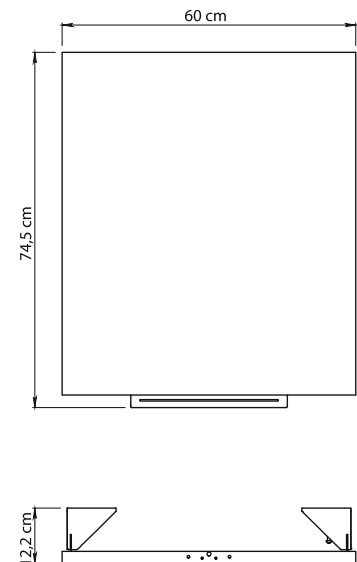

6046.

Sostegno per doccia con saliscendi

Shower support with sliding rail
Barre pour douche avec système
de fixation ajustable
Duschstangenhalterung
Soporte para ducha con columna
Штанга для душа

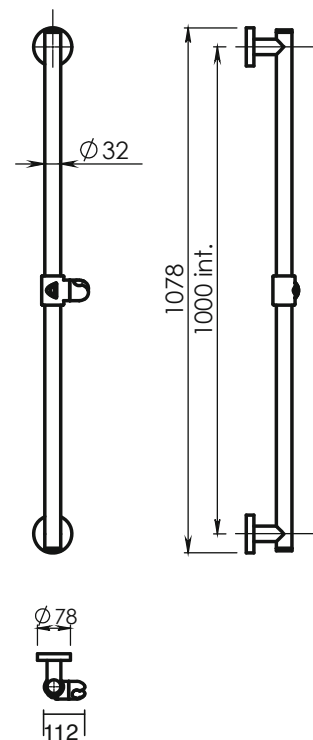

6047.



08
Grigio
Grey

L6,5 x P5 x H10 cm

Saliscendi - ABS

Shower support - ABS
Fixation douche ajustable - ABS
Duschhalterung - ABS
Soporte para ducha - ABS
Подвижный держатель для душа - ABS

CONTRACT.

6021-25.

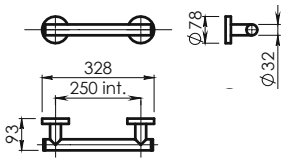

6021-45.

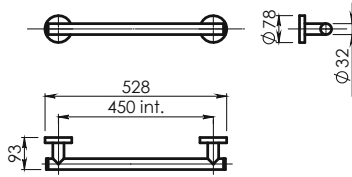

6021-55.

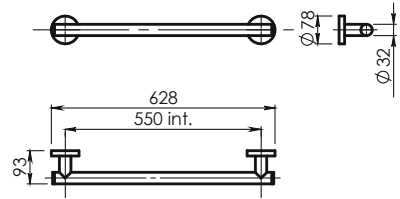

6021-65.

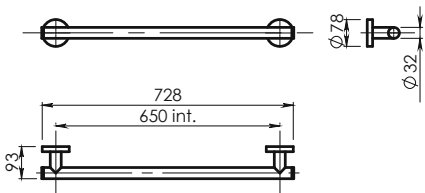

6043-10.

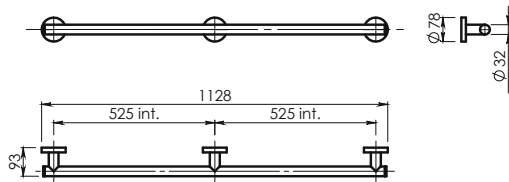

6090-44.

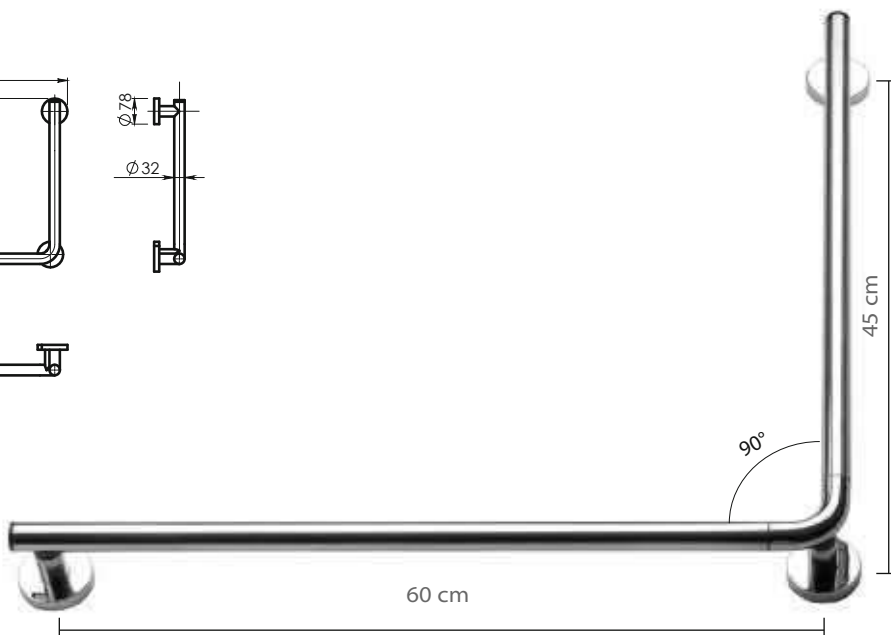
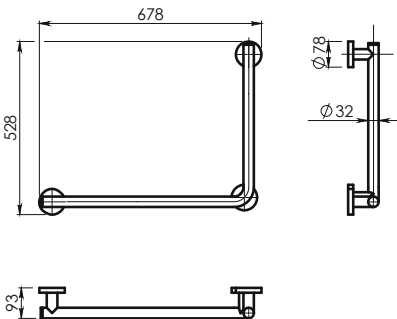

Reversible
Reversible

Appoggio ribaltabile

Safety folding handle - Barre à abattant
 Klappgriff - Soporte móvil - Мобильный поручень

design Studio Talocci Design

6057-65.*

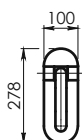
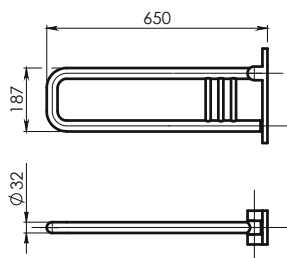

6057-75.*

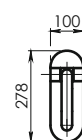
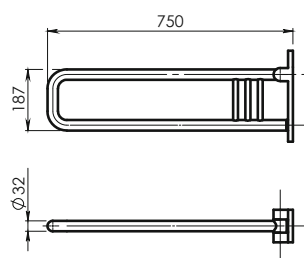

con portarotolo

with paper holder - avec porte rouleau
 mit Papierrollenhalter - con portarollo
 с бумагодержателям

6058-65.*

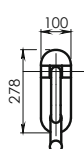
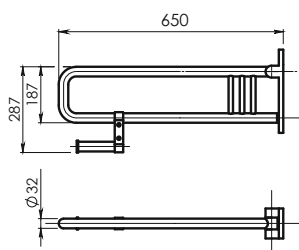

6058-75.*

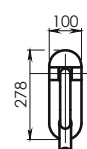
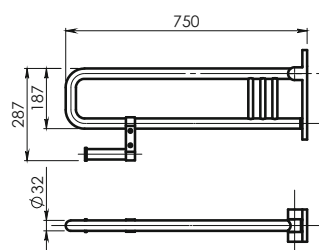

* **Meccanismo di ribaltamento in posizione orizzontale e verticale** - Collapsible mechanism in horizontal and vertical position - Mécanisme de basculement en position horizontale et verticale - Kippmechanismus in waagerechter und in senkrechter Position - Mecanismo de abatimiento en posición horizontal y vertical - Откидной механизм в вертикальном и горизонтальном положении

6059-65.

Appoggio

Safety handle - Support - Wandstützgriff
 Soporte - Обратимый

design Studio Talocci Design

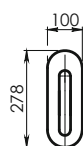
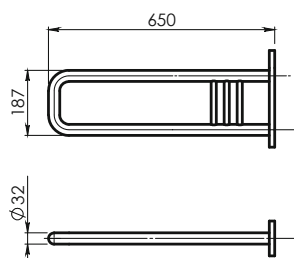

CONTRACT.

6082.



Movimento soft
Soft moving



02
Bianco
White



85
Antracite
Anthracite

design Studio Talocci Design

Sedile ribaltabile per doccia

Shower seat

Siège pour douche repliable

Duschsitz hochklappbar

Asiento móvil para ducha

Сиденье для душа

Alluminio e ABS

Aluminium and ABS

Aluminium et ABS

Aluminium und ABS

Aluminio y ABS

Алюминий и ABS

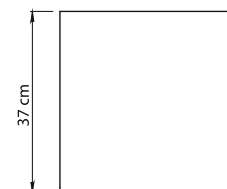
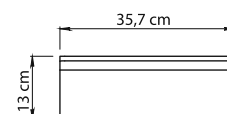

6073.

design
Studio Talocci Design & Pallocca

Sgabello

Stool

Tabouret

Hoher

Taburete

Табурет

Alluminio e ABS

Aluminium and ABS

Aluminium et ABS

Aluminium und ABS

Aluminio y ABS

Алюминий и ABS



02
Bianco
White



85
Antracite
Anthracite

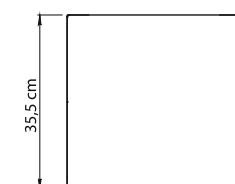
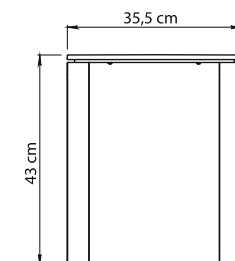

6083.



Movimento soft
Soft moving



02
Bianco
White



23
Bianco/Cromo
White/Chromed



43
Antracite/Cromo
Anthracite/Chromed

design Studio Talocci Design

Sedile ribaltabile per doccia

Shower seat

Siège pour douche repliable

Dushsitz hochklappbar

Asiento móvil para ducha

Сиденье для душа



— 4,8 —

Alluminio e ABS

Aluminium and ABS

Aluminium et ABS

Aluminium und ABS

Aluminio y ABS

Алюминий и ABS

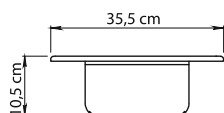
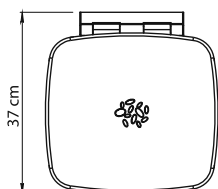

6072.



02
Bianco
White



23
Bianco/Cromato
White/Chromed



43
Antracite/Cromato
Anthracite/Chromed

design Studio Talocci Design

Sgabello

Stool

Tabouret

Hoher

Taburete

Табулет

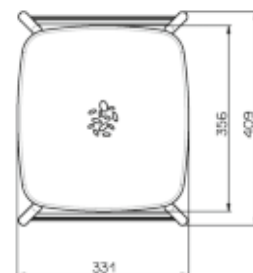
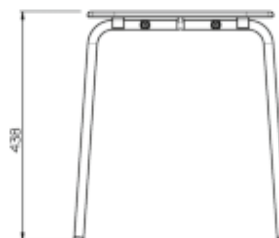

Alluminio e ABS

Aluminium and ABS

Aluminium et ABS

Aluminium und ABS

Aluminio y ABS

Алюминий и ABS

SICURA

Programma in alluminio e nylon

Program made of aluminium and nylon - Programme en aluminium et nylon

Programm aus Aluminium und Nylon - Programa en aluminio y nylon

Программа из алюминий и нейлон



02
Bianco
White

Ø 32 mm

★ **Articolo disponibile su richiesta** - Item available on request
Article disponible sur demande - Auf Anfrage erhältlich Artikel
Artículo disponible bajo petición - Продукция, изготавливаемая по заказу



100% MADE
in Italy



Un vastissimo programma di maniglioni e sistemi d'appoggio fissi e mobili in grado di soddisfare tutte le esigenze. Il sistema Sicura, offre sicurezza e libertà dalle barriere architettoniche. Copertura trattata con polveri speciali in resine epossidiche e poliestere, antiurto, antigraffio e non attaccabile dalle sostanze disinfettanti.

A very wide range of handles and fixed and movable supporting systems which will satisfy any requirements. The Sicura system, offers safety and freedom from architectural barriers. Covering treated with special epoxy and polyester resins, shockproof, scratch-proof and resistant to attack by disinfectants.

Un très vaste éventail de poignées et de systèmes d'appui fixes et mobiles en mesure de satisfaire toutes les exigences. Le système Sicura, permet de surmonter en toute sécurité et liberté les barrières architectoniques. Couverture traitée avec des poudres spéciales en résines époxy et polyester, antichoc, anti-égratignures et résistante aux substances désinfectantes.

Ein großes Angebot an Griffen, sowie festen und mobilen Stützsysteemen, die allen Ansprüchen entsprechen. Sicura System bietet Sicherheit und Unabhängigkeit von architektonischen Barrieren. Die mit Spezialpulver aus Epoxyd- und Polyesterharzen oberflächenbehandelte Serie aus Aluminium und Nylon ist schlagfest, kratzfest und

Un amplísimo programa de grilletes y de sistemas de apoyo fijos y de muebles capaces de satisfacer todas las exigencias. El sistema Sicura, ofrece seguridad y libertad de las barreras arquitectónicas. Revestimiento tratado con polvos especiales de resinas epoxídicas y poliéster, antichoque, irrayable y no atacable por las sustancias desinfectantes.

Предлагаем широкий ассортимент поручней и опорных приспособлений, как съёмных, так и стационарных, отвечающих самым разнообразным требованиям. Система Sicura, обеспечивает безопасность при отсутствии капитальных ограждений. При изготовлении используется алюминий и нейлон, а также покрытия, обработанные специальными эпоксидными и полиэфирными порошками, устойчивыми к механическим и химическим воздействиям.

4008.

Specchio basculante

Balancing mirror
Miroir basculant
Bewegbarer Spiegel
Espejo basculante
Вращающееся зеркало



GARANZIA
WARRANTY

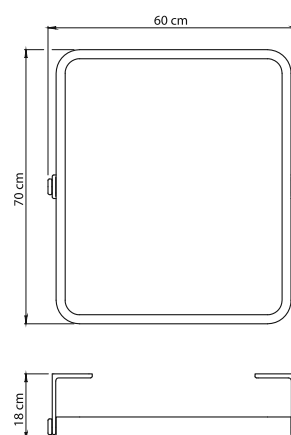

Resine termoplastiche e nylon

Thermoplastic resins and nylon
Thermoplastique et nylon
Kunststoff und nylon
Resinas termoplásticas y nylon
Термопластичных смол и нейлона

Maniglioni antiscivolo, con superfici prive di angoli

Non-slip handles, with smooth, rounded surfaces
 Poignées antidérapantes, avec surfaces sans arêtes
 Elemente mit rutschfesten Griffen und kantenlosen Oberflächen
 Grilletes antideslizantes, con superficies sin ángulos
 Нескользящие поручни с округлой поверхностью

Fissaggio orizzontale e verticale
 Horizontal and vertical fixing

4840-25.*

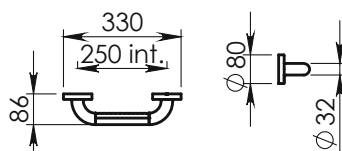

4840-45.

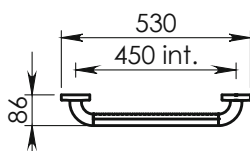

4841-55.

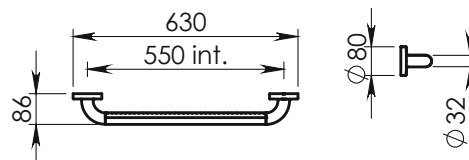

4842-65.

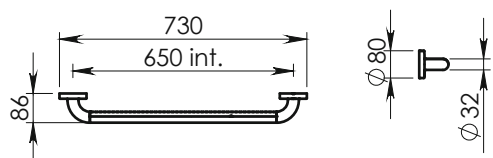

Corrimano

Wall handrail - Main courante - Wandhandlauf
 Barandilla de pared - Угловой поручень для ванной комнаты

4843-10.

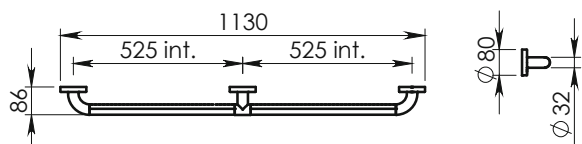

4844-11.*

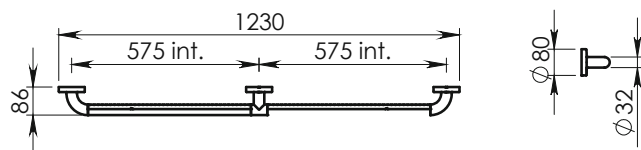

Sostegno a 90°

Holding handle 90° - Barre 90° - Wandhaltegriff 90°
 Soporte de 90° - Настенный поручень под углом 90°

4844-44.

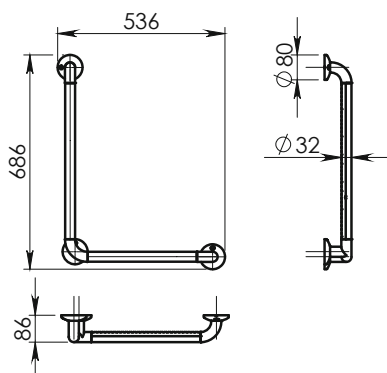

4849-44.*

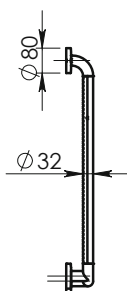
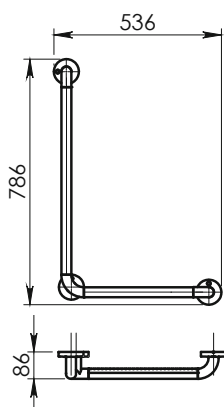

Reversible
 Reversible

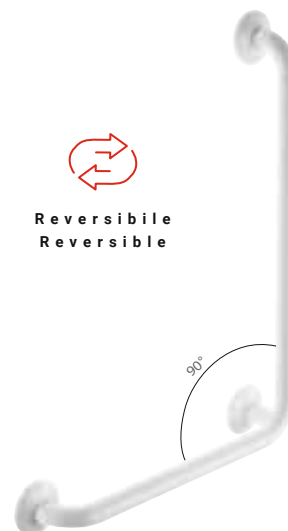

CONTRACT.

4854-77.*

Sostegno a 90°

Holding handle 90° - Barre 90° - Wandhaltegriff 90°
 Soporte de 90° - Настенный поручень под углом 90°



Reversibile
 Reversible

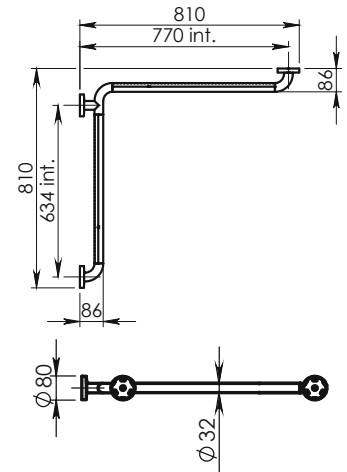

4857-64.

Appoggio ribaltabile

Safety folding handle - Barre à abattant
 Klappgriff - Soporte móvil - Мобильный поручень

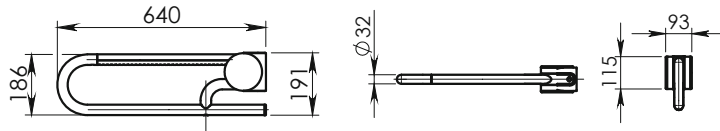

4858-74.

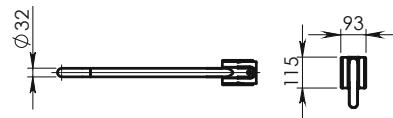
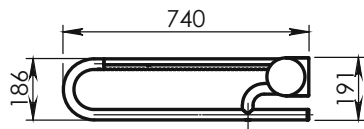

Meccanismo di ribaltamento in posizione orizzontale e verticale
 Collapsible mechanism in horizontal and vertical position
 Mécanisme de basculement en position horizontale et verticale
 Kippmechanismus in waagerechter und in senkrechter Position
 Mecanismo de abatimiento en posición horizontal y vertical
 Откидной механизм в вертикальном и горизонтальном положении

4859-64.

Appoggio reversibile

Reversible safety handle - Support réversible - Wandstützgriff reversibile
 Soporte reversible - Поручень обратимый

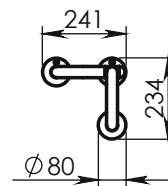
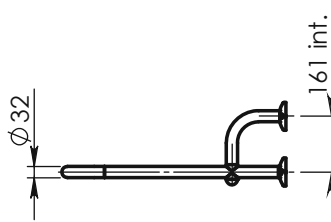
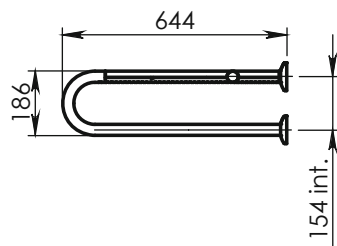

Reversibile
 Reversible

4863.*

Maniglione per vasca. Adattabile a vasche con bordo da 6 cm a 12,5 cm

Safety handle for bath. Adaptable for bath-tubs with rims from 6 cm to 12,5 cm
 Barre de sûreté pour baignoire. Adaptable à baignoires avec bord de 6 cm à 12,5 cm
 Wanneneinsteighilfe. Verwendbar für Wannen mit einer Wandstärke von 6 cm bis 12,5 cm
 Asidero para bañera.
 Adaptable a bañeras con borde de 6 cm a 12,5 cm
 Двойной поручень на ванну. Устанавливается на ванны, имеющие стенку от 6 до 12,5 см

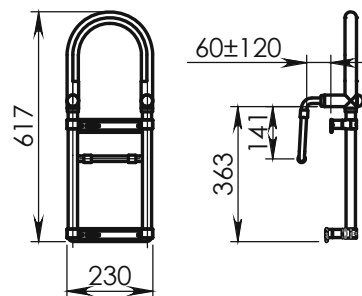

2284.

Sedile estensibile per vasca

Bath tub seat - Siège pour baignoire
Badewannensitz - Asiento para bañera
Раскладное сиденье для ванной

Resine termoplastiche e alluminio

Thermoplastic resins and aluminium
Thermoplastique et aluminium
Kunststoff und Aluminium
Resinas termoplásticas y aluminio
Термопластичных смол и алюминий



Regolabile
Adjustable

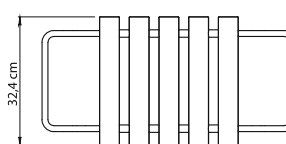
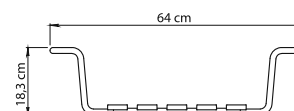

Braccioli estensibili per vasche con misura interna di 50-65 cm

Extendable arms for baths with internal measurement 50-65 cm
Bras extensibles pour baignoires aux dimensions intérieures de 50-65 cm
Verlängerbare Armlehnen für Wannen mit einem Innenmaß von 50-65 cm
Ароуабразос extensibles para bañeras con medidas interiores de 50-65 cm
Выдвижные поручни для ванны, имеющей внутреннюю ширину от 50 до 65 см

2283.

Sedile ribaltabile per doccia

Shower seat - Siège pour douche repliable
Duschsitz hochklappbar - Asiento móvil para ducha
Сиденье для душа

Resine termoplastiche e alluminio

Thermoplastic resins and aluminium
Thermoplastique et aluminium
Kunststoff und Aluminium
Resinas termoplásticas y aluminio
Термопластичных смол и алюминий

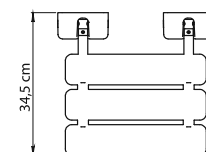
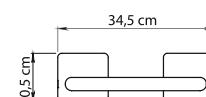

4896.*

Sedile con seduta liscia ergonomica agganciabile a maniglione

Hanging smooth shower seat for grab bar system
Siège pour douche avec assise lisse,
accrochable à barre d'appui
Einhängesitz für Griffsystem mit glatter Sitzfläche
Asiento colgado para ducha con silla lisa
ergonómica por el sistema de asideros
Сиденье с гладкой поверхностью, прицепляемое к рукоятке

Resine termoplastiche e alluminio

Thermoplastic resins and aluminium
Thermoplastique et aluminium - Kunststoff und Aluminium
Resinas termoplásticas y aluminio
Термопластичных смол и алюминий

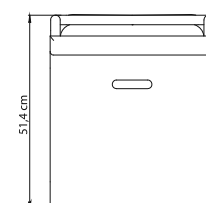
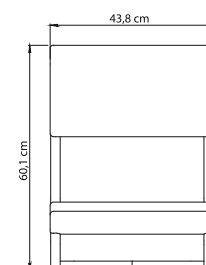

CONTRACT.



GARANZIA
WARRANTY

FORTIS



Ø 30 mm

02
Bianco
White



100% MADE
in Italy



Programma di maniglioni e sistemi d'appoggio fissi e mobili realizzato in acciaio zincato con verniciatura con polveri speciali in resine epossidiche e poliestere e attacchi in Ultraform®.

Range of handles and fixed and movable supporting systems made of zincated steel with covering treated with special epoxy and polyester resins and wall plates in Ultraform®.

Programme de poignées et de systèmes d'appui fixes et mobiles, réalisé en acier zingué avec laquage traité avec des poudres spéciales en résines époxy et polyester et plaques à mur en Ultraform®.

Serie von Griffen, sowie festen und mobilen Stützsystemen, hergestellt aus mit Spezialpulver aus Epoxyd- und Polyesterharzen oberflächenbehandeltem verzinkten Stahl mit Wandbefestigungen aus Ultraform®.

Programa de grilletes y de sistemas de apoyo fijos y de muebles realizado en acero galvanizado con revestimiento tratado con polvos especiales de resinas epoxídicas y poliéster y placas de pared en Ultraform®.

Ассортимент поручней и опорных приспособлений, как съёмных, так и стационарных, изготовлено из оцинковыванной стали, а также покрытия, обработанные специальными эпоксидными и полиэфирными порошками и с плитами стены в Ultraform®.



Maniglioni

Grab bar - Barre d'appui - Wannengriff- Asideros - Поручень

Fissaggio orizzontale e verticale

Horizontal and vertical fixing

6421-30.

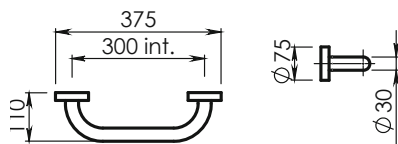

6421-45.

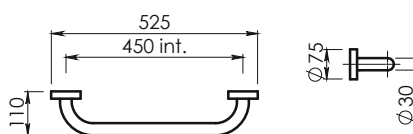

6421-60.

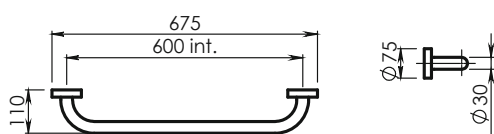

6421-90.

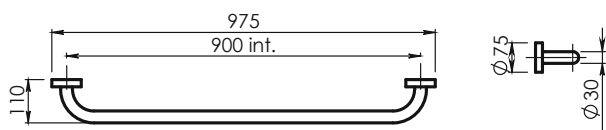

Sostegno a 90°

Holding handle 90° - Barre 90° - Wandhaltegriff 90°
 Soporte de 90° - Настенный поручень под углом 90°

6490-00.

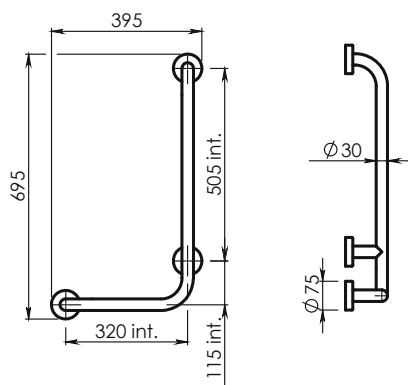

6490-01.

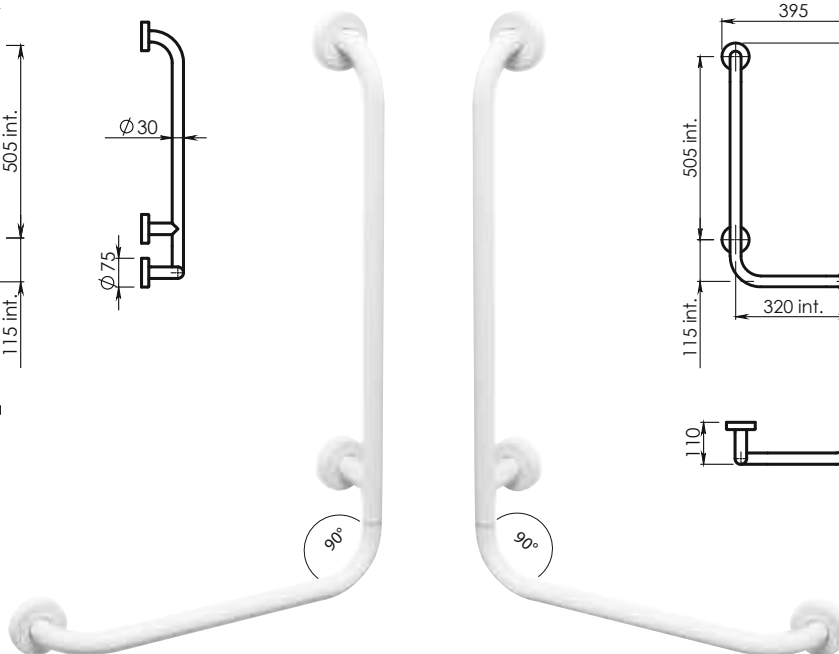
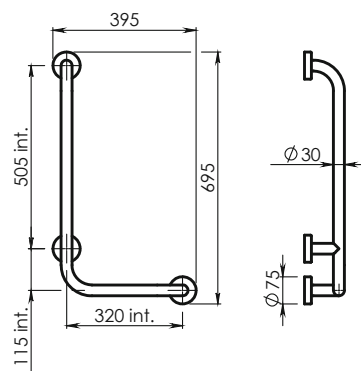

CONTRACT.

Sostegno a 90°

Holding handle 90° - Barre 90° - Wandhaltegriff 90°
Soporte de 90° - Настенный поручень под углом 90°

6445.

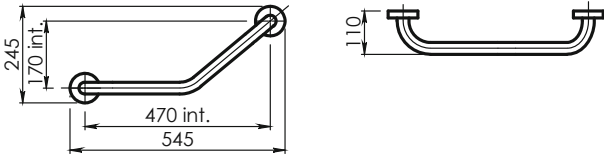

Reversibile
Reversible

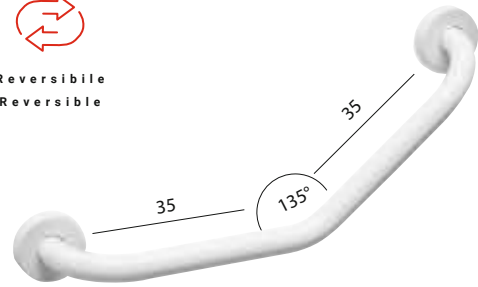

Appoggio ribaltabile

Safety folding handle - Barre à abattant
Klappgriff - Soporte móvil - Мобильный поручень

6465.

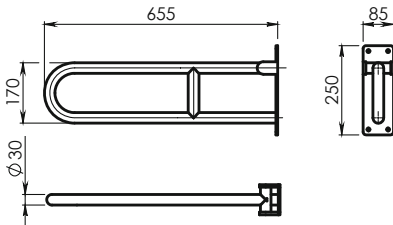

6466.

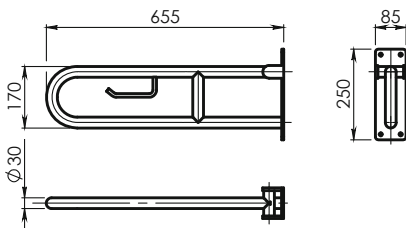

con portarotolo

with paper holder - avec porte rouleau
mit Papierrollenhalter - con portarollo
с бумагодержателям

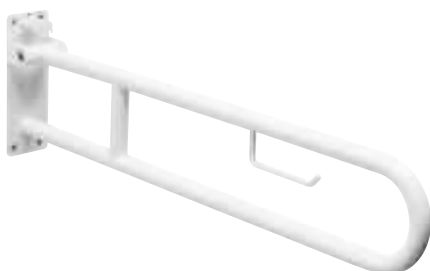

Maniglione verticale parete-parete

Wall-wall upright handle
Barre de relèvement
verticale paroi-paroi
Senkrechter Griff Wand-Wand
Barra vertical pared-pared
Вертикальная ручка
стена-стена

6450.

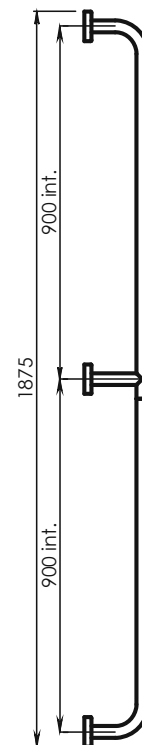
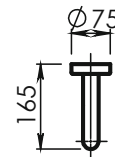

Meccanismo di ribaltamento in posizione orizzontale e verticale - Collapsible mechanism in horizontal and vertical position - Mécanisme de basculement en position horizontale et verticale - Kippmechanismus in waagerechter und in senkrechter Position - Mecanismo de abatimiento en posición horizontal y vertical - Откидной механизм в вертикальном и горизонтальном положении

FRIEND

Programma in resine termoplastiche

Program made of thermoplastic resins
 Programme en résine thermoplastique
 Programm aus Kunststoff - Programa en resinas termoplásticas
 Программа из термопластичная смоль



02
 Bianco
 White

1021-20.

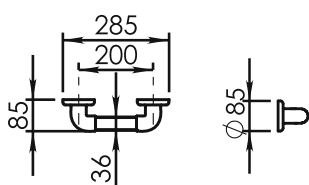

100% MADE
 in Italy



CONFORME - IN CONFORMITY WITH UNI11064:2003

1021-30.

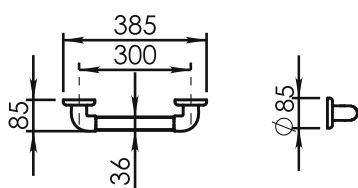

1021-45.

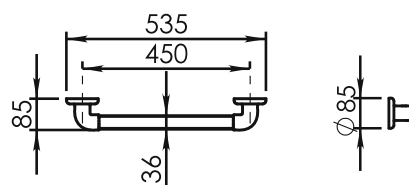

1083.

Sedile estensibile per vasca

Extending bath seat
 Siège de baignoire extensible
 Ausziehbarer Badewannensitz
 Asiento extensible para bañera
 Сиденье для ванны раздвижное



Regolabile
 Adjustable

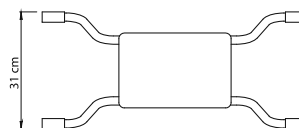
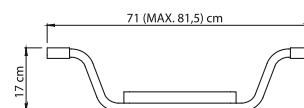

Alluminio e polietilene

Aluminum and Polyethylene - Aluminium et Polyéthylène
 Aluminium und Polyethylen - Aluminio y Polietileno - Алюминий и Полиэтилен

1072.

Sgabello

Stool
 Tabouret
 Hocker
 Taburete
 Табурет



Regolabile
 Adjustable

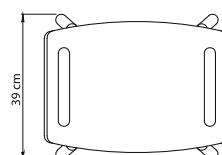
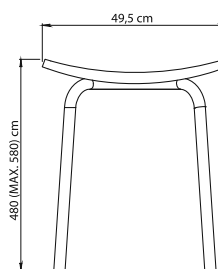

Alluminio e polietilene

Aluminum and Polyethylene - Aluminium et Polyéthylène
 Aluminium und Polyethylen - Aluminio y Polietileno - Алюминий и Полиэтилен



 bamboom

Himalaya.



Realizzata in bambù

Made of bamboo

Réalisée en bambou

Hergestellt aus Bambus

Realizada en bambù

Изготовлено из бамбука



Con viti

With screws



Natural



Bambù

Bamboo



Save

the planet



GARANZIA

WARRANTY



35

Naturale
Natural

Himalaya.

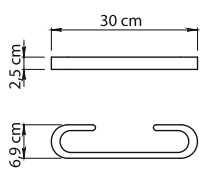
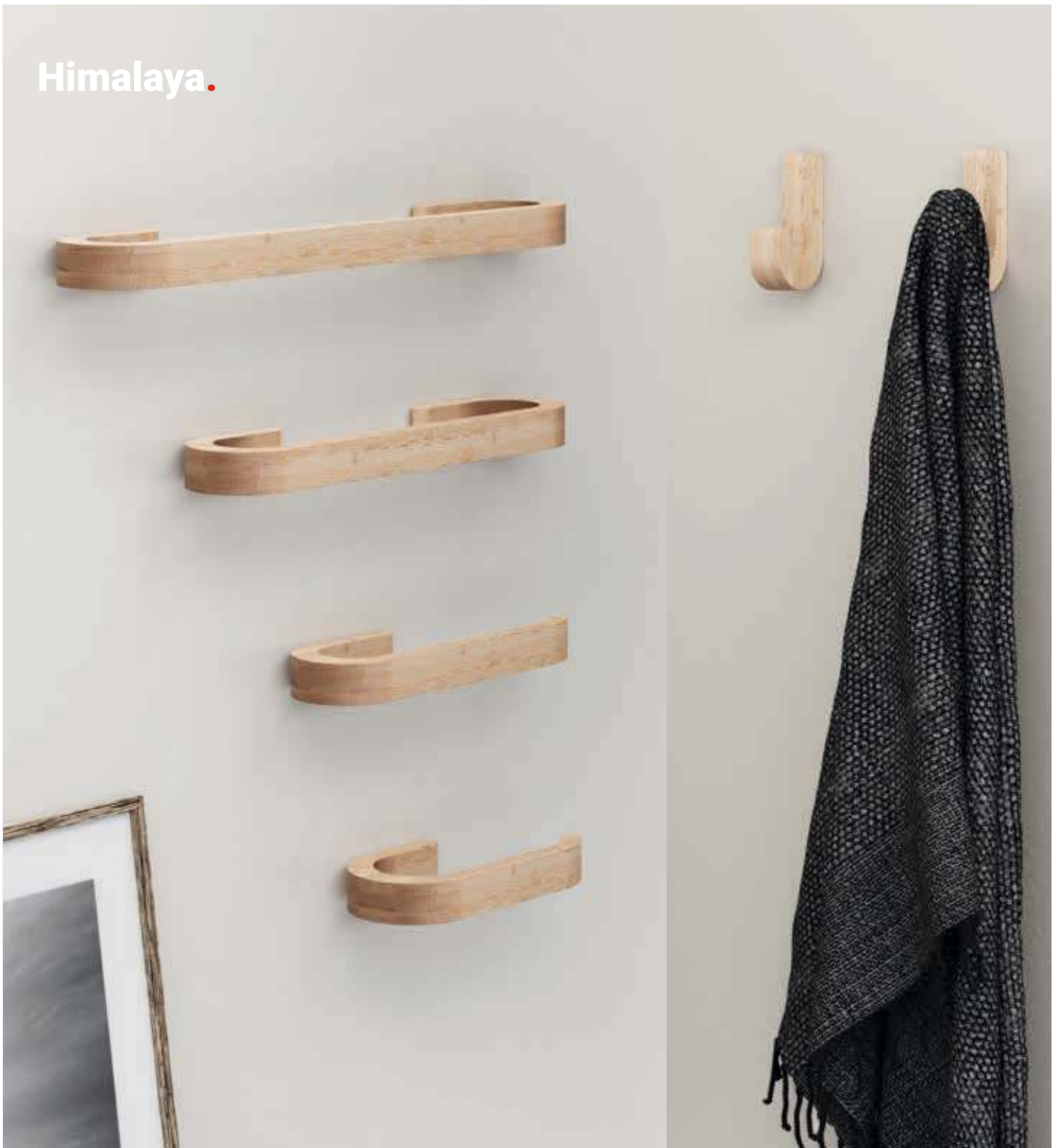

HY21-30

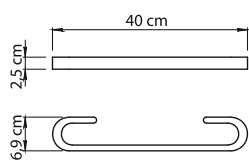

HY21-40

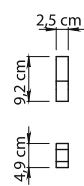

HY26
2 pz - 2 pcs

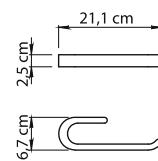

HY70

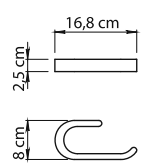

HY24

BAMBOOM .

GEDY

bamboom®

Afrodite.

Realizzata in cemento e bambù

Made of concrete and bamboo

Réalisée en béton et bambou

Hergestellt aus Zement und Bambus

Realizada en cemento y bambú

Изготовлено из бетона и бамбука



Natural



Bambù

Bamboo



Save
the planet



08
Grigio
Grey



4998

ø 7,5 x H11,5 cm



4911

L12,8 x P8,4 x H3 cm



4980

ø 7,6 x H17,2 cm



4906

L30,5 x P10,4 x H3,2 cm



4933

ø 9,3 x H47 cm

BAMBOOM .

GEDY

Dafne.

Realizzata in bambù

Made of bamboo

Réalisée en bambou

Hergestellt aus Bambus

Realizada en bambú

Изготовлено из бамбука

bamboom®



Natural



Bambù

Bamboo



Save

the planet



30

Noce

Walnut colour



3998

L8 x P8 x H13 cm



3911

L14 x P8 x H2,2 cm



3980

L8 x P8 x H18,5 cm



3933

L9,5 x P9,5 x H47 cm

BAMBOOM .

GEDY

Altea.

Realizzata in bambù

Made of bamboo

Réalisée en bambou

Hergestellt aus Bambus

Realizada en bambú

Изготовлено из бамбука

bamboocom®



Natural



Bambù

Bamboo



Save
the planet



35
Naturale
Natural



AL98

ø 7 x H12 cm



AL11

ø 11,7 x H2 cm



AL80

ø 7 x H17,2 cm



AL33

ø 8,5 x H47,5 cm

BAMBOOM.

GEDY

Bonnie.



bamboom®



Natural

Bambù

Bamboo

Save

the planet

41

Naturale/nero matt
Natural/matt black

Realizzata in bambù

Made of bamboo

Réalisée en bambou

Hergestellt aus Bambus

Realizada en bambú

Изготовлено из бамбука



35
Naturale
Natural



BN98

L7,4 x P7,4 x H11 cm



35
Naturale
Natural



BN11

L13,4 x P9,6 x H2,5 cm



BN80

L7,4 x P7,4 x H16,8 cm



BN33

L10 x P10 x H36,5 cm



BN34

L10 x P10 x H39,5 cm

BAMBOOM .

GEDY

bamboom®

Ninfea.

Realizzata in resina e bambù

Made of resin and bamboo

Réalisée en résine et bambou

Hergestellt aus Harz und Bambus

Realizada en resina y bambú

Изготовлено из бамбука и смол



Natural



Bambù

Bamboo



Save

the planet



02

Bianco matt
Matt white



14

Nero matt
Matt black



1398

L12,8 x P5,6 x H8,5 cm



1311

L12,8 x P8,2 x H3 cm



1380

L12,8 x P5,6 x H15,7 cm



35
Naturale
Natural



1306

L29,7 x P15,2 x H2 cm



1333

L9,3 x P9,3 x H46,2 cm

BAMBOOM .

GEDY

bambocom®

Thea.

NEW



47

Naturale/Verde
Natural/Green

Realizzata in bambù e resina

Made of bamboo and resin

Réalisée en bambou et résine

Hergestellt aus Bambus und Harz

Realizada en bambú y resina

Изготовлено из бамбука и бамбука

Natural

Bambù

Bamboo

Save

the planet



07
Verde
Green



TH98

ø 7,5 x H10,5 cm



TH11

ø 12 x H2,3 cm



TH80

ø 7,5 x P8,5 x H15 cm



TH03

ø 9,5 x H7,3 cm



TH06

L27,5 x P11,8 x H1,5 cm



35
Naturale
Natural



TH33

ø 9,5 x H35 cm

BAMBOOM.

Kenta.

GEDY

Realizzate in bambù e metallo

Made of bamboo and metal

Réalisés en bambou et métal

Hergestellt aus Bambus und Metall

Realizadas en bambù y metal

Изготовлено из бамбука и металл



40

Naturale/Bianco matt
Natural/Matt white



41

Naturale/Nero matt
Natural/Matt black



Natural



Save
the planet



Bambù
Bamboo



1409 - 5 lt

ø 20,5 x 26 x 26,5 cm



1309 - 3 lt

ø 17 x 22 x 25 cm



Soft close

BAMBOOM.

Trilly.

GEDY

Acciaio inox e bambù

Stainless steel and bamboo

Acier inoxydable et bambou

Edelstahl und bambus

Acero inox y bambú

Нержавеющей стали и Бамбука



41
Naturale/Nero matt
Natural/Matt black



GARANZIA
WARRANTY



Natural



Save
the planet



Bambù
Bamboo



TR31

H84 cm

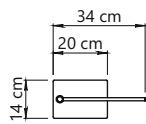

TR32

H63 cm



BAMBOOM .

Panda.

GEDY

Bambù

Bamboo
Bambou
Bambus
Bambú
Бамбука



35
Naturale
Natural



Natural



Save
the planet



Bambù
Bamboo



1031

H190 cm

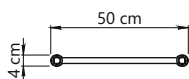

BAMBOOM.

Juncos.

GEDY



41

Naturale/Nero matt
Natural/Matt black

Bambù e metallo

Bamboo and metal
Bambou et métal
Bambus und Metall
Bambú y metal
Бамбука и металл



Con biadesivo
With double
sided tape



Natural



Save
the planet



Bambù
Bamboo



1126

Ø 5 x P3,8 cm



1127

L10 x P3,8 x H5 cm



1126

L5 x P3,8 x H5 cm



1127

L10 x P3,8 x H5 cm



BAMBOOM.

Merlino.

GEDY



Natural



Save
the planet



Bambù
Bamboo



35
Naturale
Natural

Realizzate in bambù

Made of bamboo
Réalisés en bambou
Hergestellt aus Bambus
Realizadas en bambù
Изготовлено из бамбука



2026

L2,5 x P5,7 x H12,5 cm



Ilan.

NEW

GEDY



Natural



Save
the planet



Bambù
Bamboo



35
Naturale
Natural

Bambù

Bamboo
Bambou
Bambus
Bambú
Бамбука



IA06

L34 x P23 x H1,8 cm



BAMBOOM.

Yoshi.

GEDY



Natural



Save
the planet



Bambù
Bamboo



05
Blu
Blue



08
Grigio
Grey

Bambù e poliestere

Bamboo and polyester - Bambou et polyester

Bambus und polyester - Bambú y poliéster - Бамбука и Полиэстер



1338 - 87 lt

L53 x P34 x H51 cm

Tatami.

GEDY



Natural



Save
the planet



Bambù
Bamboo



02
Bianco
White



14
Nero
Black

Bambù e cotone

Bamboo and cotton - Bambou et coton - Bambus und Baumwolle

Bambú y algodón - бамбук и хлопок



TA38 - 68 lt

L35,5 x P35,5 x H63 cm

BAMBOOM .

Nature.

GEDY

Bambù

Bamboo
Bambou
Bambus
Bambú
Бамбука



35
Naturale
Natural



Natural



Save
the planet



Bambù
Bamboo



2490

L27 x P12 x H61 cm



ΕΚϋπλα



EKOPLA'.

GEDY

Seventy.

design Matteo Thun

NEW

100% MADE
in Italy



Save the
planet



Riciclabile
Recyclable



Riciclato
Recycled



14
Nero matt
Matt black

Materiale plastico riciclato

Recycled plastic

Plastique recyclé

Recyceltes Kunststoffmaterial

Material plástico reciclado

Переработанный пластик



6398

L6,5 x P6,5 x H12,2 cm



6312

L12,4 x P8 x H2,1 cm



6382

L6,5 x P7,1 x H16 cm



6333

L9 x P9 x H38,8 cm

design
R & S Gedy

Seventy.

GEDY

NEW



08
Grigio matt
Matt grey



14
Nero matt
Matt black



22
Bianco matt
Matt white



Save the
planet



Riciclabile
Recyclable



Riciclato
Recycled

100% MADE
in Italy



07
Verde matt
Matt green



17
Verde salvia matt
Matt green sage



6333

L9 x P9 x H38,8 cm

Materiale plastico riciclato

Recycled plastic

Plastique recyclé

Recyceltes Kunststoffmaterial

Material plástico reciclado

Переработанный пластик



GEDY S.p.A

Via dell'Industria, 6
21040 Origgio (VA) - Italia
Tel. +39.02.96.95.01
Fax +39.02.96.73.43.01
www.gedy.com - info@gedy.com

